

# 2009 PRODUCTS CATALOGUE

Air Conditioner of Fujitsu General  
The Intelligent Choice in Comfort

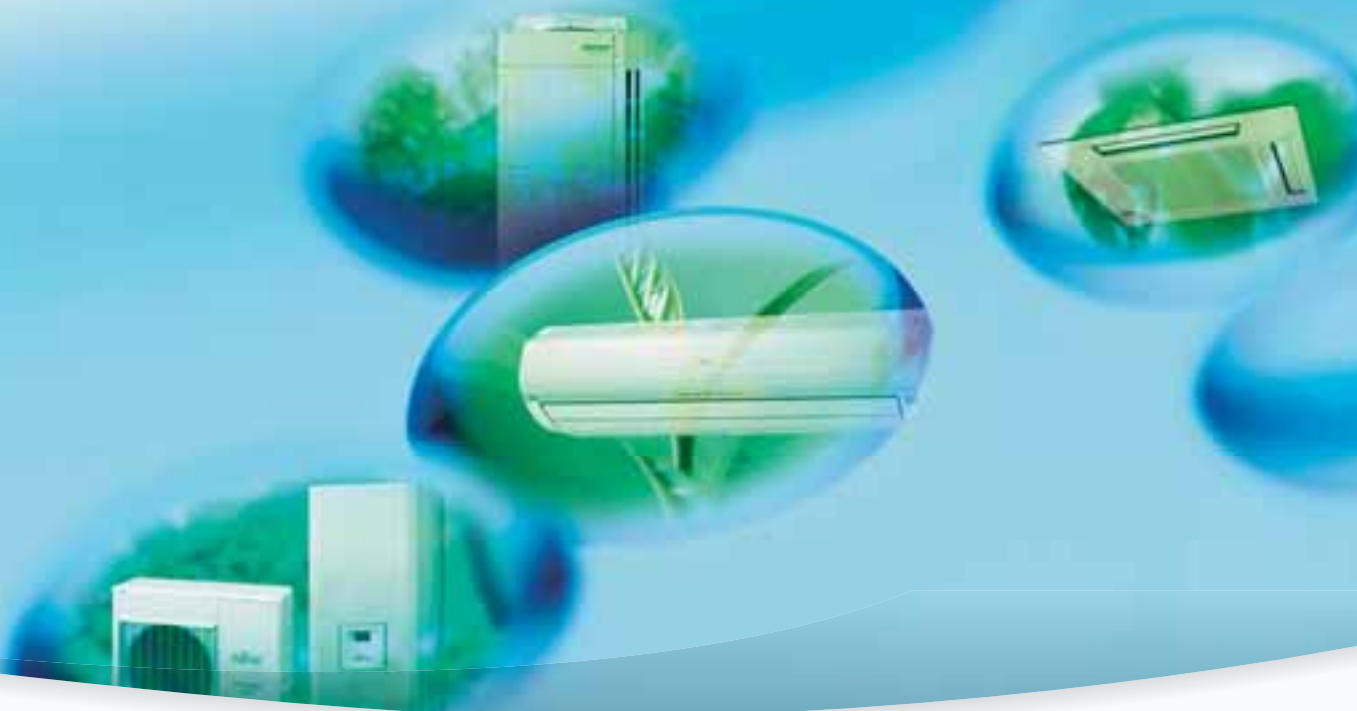

Split  
Multi Split  
VRF  
Window  
Energy Recovery Ventilator  
Air to Water  
Deodoriser

A stylized globe is the central focus, rendered in shades of blue and green. The globe's surface is textured with various green leaves, suggesting a connection to nature and environmental friendliness. The background is a solid, vibrant blue. A thin, light-colored arc curves across the middle of the globe. The overall aesthetic is clean, modern, and eco-friendly.

# Creation of Comfort

Fujitsu General creates high-quality and environmentally-friendly products that provide good comfort in accordance with our basic policy to a “create comfortable environment” by utilizing the air conditioning technology and creativity we have fostered over many years.

## Creating top-class Products with Better Energy Saving and Comfort.



Creating top-class products that exceed the energy saving standards of a variety of areas by expanding the range of models incorporating new refrigerant and inverter technology to create our original energy saving technology that achieves both energy saving and comfort.



### V-PAM

V-PAM technology makes the compressor more powerful.



Automatic filter cleaning air conditioner

## Harmony between Global Environmental Protection and Company Activities

The Fujitsu General Group strives for business activities that achieve harmony between contributing to protecting the global environment and company activities while making environmental protection activities an important issue in company management.

The Fujitsu General Group is working to improve its environmental friendliness by building an environmental management system (EMS); taking environmental protection measures throughout the product lifecycle of materials procurement, product development and design, manufacturing, and recycling; and by taking the environment into consideration during business activities such as by saving energy and resources and reducing waste.

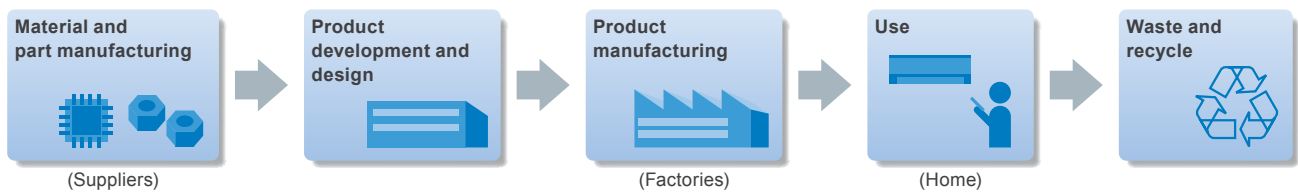

## High-quality Development Environment

The Headquarters-Kawasaki R&D Center is equipped with a wide range of testing equipment envisioning a variety of operating conditions. This includes a testing tower with a 60m height difference for simulating use of multi air conditioning system for buildings. We create new products that exceed strict development and quality standards to meet the needs of the next generation as well as the requirements of today's market.



Kawasaki R&D Center and 60m height difference testing tower

# All Technologies for Energy Saving

A variety of attractive and world-leading energy saving technologies and controls are incorporated into all products to aim for energy saving throughout the year.

## All DC Saves Energy Throughout the Year

By making all the motors DC, electricity loss is decreased and power consumption is substantially reduced. In addition, fan motor high speed rotation is possible, and heat exchange efficiency is increased and annual power consumption amount is saved by increasing the airflow.



### Axial Gap Fan Motor

Compact size with 1.5 more power output Self-driven method increases rotating efficiency by 10%. Our electromagnetic field simulation technology enables low vibration and low noise.

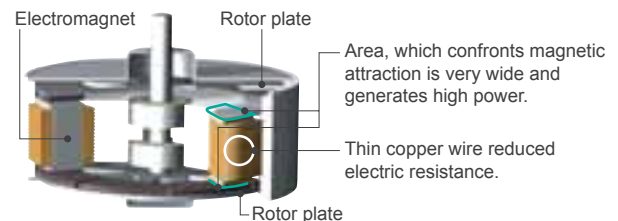

### High Efficiency DC Twin Rotary Compressor

A high performance, low noise, large capacity DC Twin Rotary Compressor is used for VRF.

Each part is optimized with intake and compression efficiency increased to the maximum extent.







**V**  
V-PAM  
**Vector PAM Inverter**  
(I-PAM + vector control)

The voltage of the compressor and the timing of the current connection are enhanced. This is the advanced technology of PAM control system which improved the maximum compressor speed and operation efficiency.

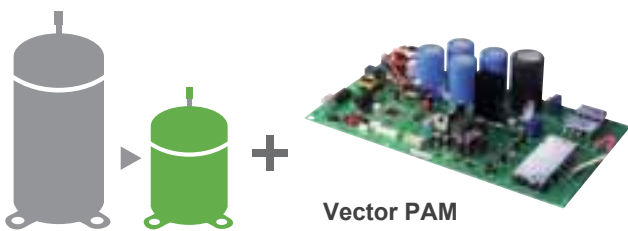

**Miniaturization of conventional compressor**

**Vector PAM**  
It became more powerful by the newly developed high efficient compressor motor control "Vector PAM Technology"

**COP (Coefficient of Performance)**

5 years ago  
ASY13PA

3.01

This year  
AWYZ14LB

4.44

**i**  
i-PAM  
**I-PAM Control**  
(PAM+IPM)

IPM board made the conventional inverter PAM control possible to obtain high-voltage and high power at the time of operation starts. The preset temperature is kept with low voltage during the stable operation. Thus, higher performance and more energy saving are realized than the current inverter models.

"I-PAM(Intelligent power module-Pulse Amplitude Modulation)"

**Energy saving and speedy heating only possible by I-PAM**

Attain your desired temperature just 1/3 of time comparing to our conventional inverter models.

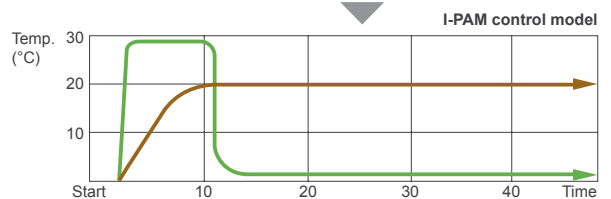
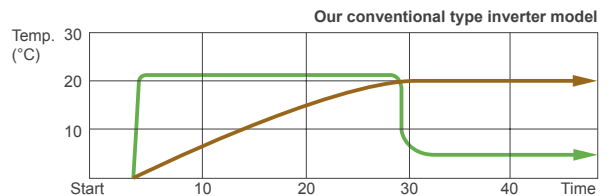

— Voltage and speed of compressor motor — Temperature of 10cm above the floor  
Illustrations and graphs may differ from actual state.

# Class A Proves Trust

Our models have earned the "Class A" ranking, the highest energy saving standard that is shown on energy labels in Europe.

## Energy-Efficiency Classifications

According to a new EC Directive, the indication of the Energy Efficiency classification on household air conditioners became compulsory. This aims to provide consumers with clear and objective information regarding energy-saving, and to encourage them to select products that are environmentally friendly. An Energy Label, like that shown in the sample below, will be provided in shop displays. In the label, the equipment is rated, with "A" being the most efficient. You may notice these labels and ratings appearing soon in shops that sell air conditioners. For easy understanding, the following information will be indicated for each model.



Energy Label

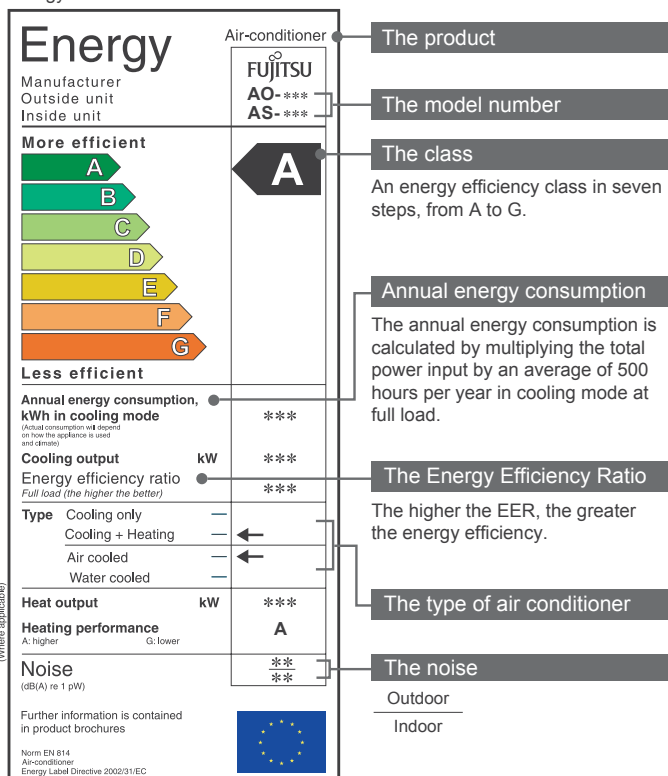

## Classifications

There are seven classifications of energy efficiency, from A to G. The most efficient level is "A" and the least efficient level is "G".

Energy efficiency class of the unit in COOLING mode	Energy efficiency class of the unit in HEATING mode
A: $3.20 < EER$	A: $3.60 < COP$
B: $3.20 \geq EER > 3.00$	B: $3.60 \geq COP > 3.40$
C: $3.00 \geq EER > 2.80$	C: $3.40 \geq COP > 3.20$
D: $2.80 \geq EER > 2.60$	D: $3.20 \geq COP > 2.80$
E: $2.60 \geq EER > 2.40$	E: $2.80 \geq COP > 2.60$
F: $2.40 \geq EER > 2.20$	F: $2.60 \geq COP > 2.40$
G: $2.20 \geq EER$	G: $2.40 \geq COP$

These classifications are for split and multi-split air conditioners.

# More Comfort



## Low Noise Operation Technology

The noise from indoor and outdoor units has been greatly reduced by utilizing advanced refrigerant simulation, efficient blower mechanism design, and low noise control technology. We pursue quieting technologies for all applications from residential to commercial to provide you with a pleasant air-conditioned life.



## Clean & Convenience

### Clean & Energy Efficiency Technology

Fujitsu General has developed industry-leading unique products such as an automatic filter cleaner that keeps the air clean while reducing lost efficiency and a washable front panel that can be easily removed and cleaned. We create new air conditioners that reflect potential user needs while also achieving both energy saving and comfort.

Automatic filter cleaner

**WORLD FIRST** \*1

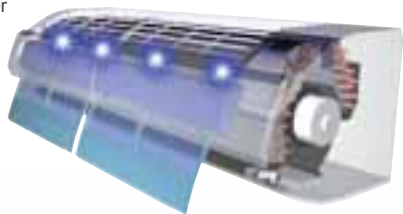

Washable panel



\*1: Announced September 9, 2002. In room air conditioner for the home (Our company's investigation)

### User Friendly Control

Fujitsu General is using ergonomics to expand the use of user friendly designs such as easy-to-read large LCD displays, easy-to-operate buttons, and displays with easily recognizable colors and icons. We are producing control systems that provide greater convenience for both individual and centralized control with operability suitable for the application and such features as one-touch selection and a range of batch control operation methods.



Large-sized liquid crystal remote controller



Touch panel controller for VRF system

# New Products

## Split

### 3-phase inverter single split

Range 10.0 kW to 14.0 kW



P014

Model code	36	45	54
Cassette			
Ceiling			
Duct			
High Static Pressure Duct			

## Multi Split

### 4.0 kW 2-room inverter multi split

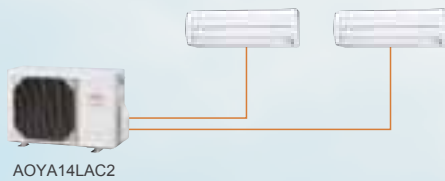

P062

Model code	7	9	12
Wall Mounted			

### 3-phase simultaneous operation inverter multi

Range 10.0 kW to 14.0 kW

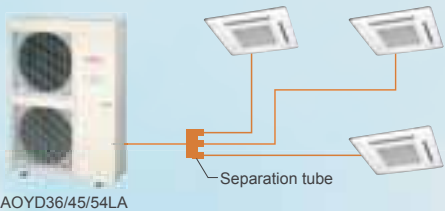

P070

Model code	18	22	24
Cassette			
Floor / Ceiling			
Duct			

## VRF

Newly designed compact outdoor unit  
Space saving combination and High efficiency combination new lineup models for heat pump type.

P102

HP
8/10/12/14/16/18/20/22/ 24/26/28/30/32/34/36/38/ 40/42/44/46/48

**AIRSTAGE V-II**

## Air to Water

High efficiency domestic space and water heating based on heat pump inverter technology.

P148

kW
5/6/8/10/13/16

**WATERSTAGE**



# Contents

014

## Split

Ceiling Wall  
Wall Mounted  
Floor  
Compact Cassette  
Cassette  
Floor / Ceiling  
Ceiling  
Compact Duct  
Duct  
High Static Pressure Duct

060

## Multi Split

2 & 3-4 Rooms  
Simultaneous Multi  
Big Multi

074

## VRF

AIRSTAGE J  
AIRSTAGE S  
AIRSTAGE V  
AIRSTAGE V-II  
Control System

138

## Optional Parts

142

## Energy Recovery Ventilator

146

## Window

148

## Air to Water











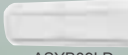
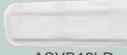
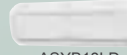
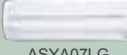
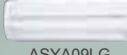
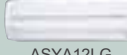
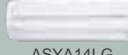
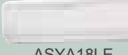
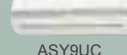
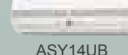
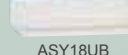





154



## Deodoriser





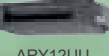
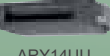
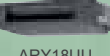







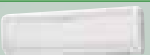
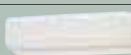
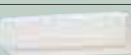













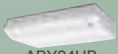



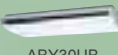





158





## Feature Explanation

# All Type Lineup Split & Multi Split

Split		2.0	2.6	3.5	4.1	5.3
Capacity (kW)		7	9	12	14	18
Model Code						
Ceiling Wall ▶ 016 page	INVERTER					
					AWYZ14LB	AWYZ18LB
Wall Mounted Plasma ▶ 018 page	INVERTER					
			ASYB09LD	ASYB12LD		ASYB18LD
Wall Mounted ▶ 020 page	INVERTER					
		ASYA07LG	ASYA09LG	ASYA12LG	ASYA14LG	ASYA18LE
	Constant					
		ASY7UB	ASY9UC	ASY12UC	ASY14UB	ASY18UB
Floor ▶ 028 page	INVERTER					
			AGYF09LA	AGYF12LA	AGYF14LA	
Compact Cassette / Cassette ▶ 030 page	INVERTER					
				AUYF12LA	AUYF14LA	AUYF18LB
	Constant					
				AUY12UB	AUY14UB	AUY18UB
Floor / Ceiling ▶ 040 page	INVERTER					
						ABYF18LB
	Constant					
					ABY14UB	ABY18UB
Ceiling ▶ 044 page	INVERTER					
	Constant					
Compact Duct / Duct ▶ 048 page	INVERTER					
				ARYF12LA	ARYF14LA	ARYF18LB
	Constant					
		ARY7UU	ARY9UU	ARY12UU	ARY14UU	ARY18UU
High Static Pressure Duct ▶ 056 page	INVERTER					
	Constant					



Multi Split		2.0	2.6	3.5	4.1	5.3
Up to 2 Units ▶ 062 page	INVERTER					
					AOYA 14LAC2	AOY 18LMAK2
Up to 3 Units ▶ 062 page	INVERTER					
						AOYA 18LAT3
Up to 4 Units ▶ 062 page	INVERTER					
Simultaneous Multi Twin / Triple ▶ 070 page	INVERTER					
Big Multi ▶ 072 page	Individual	Constant				
	Simultaneous	Constant				

	7.1 24	8.8 30	10.6 36	13.2 45	15.8 54	17.6 60	26.4 90
 AWYZ24LB							
 ASYB24LD							
 ASYA24LC	 ASYA30LC						
 ASY24UB	 ASY30UB						
 AUYF24LB	 AUYA30LB	 AUYA36LB/AUYA36LC <b>NEW</b>	 AUYA45LA	 AUYA45LC <b>NEW</b>	 AUY54LU	 AUYA54LC <b>NEW</b>	
 AUY25UU	 AUY30UU	 AUY36UU	 AUY45UU	 AUY54UU			
 ABYF24LB							
 ABY24UB							
	 ABYA30LB	 ABYA36LB/ABYA36LC <b>NEW</b>	 ABYA45LC <b>NEW</b>	 ABYA54LC <b>NEW</b>			
	 ABY30UB	 ABY36UB	 ABY45UB	 ABY54UB			
 ARYF24LB	 ARYA30LB	 ARYA36LB/ARYA36LC <b>NEW</b>	 ARYA45LC <b>NEW</b>				
 ARY25UU	 ARY30UU	 ARY36U(1)/ARY36UU	 ARY45UU	 ARY45LH/ARYC45LC <b>NEW</b>	 ARY54LU/ARYC54LC <b>NEW</b>		
						 ARY60UU	 ARY90TL

 AOY 24LMAM2							
 AOYA 24LAT3							
	 AOY 30LMAW4						
		 AOYD 36LATT <b>NEW</b>	 AOYD 45LATT <b>NEW</b>	 AOYD 54LATT <b>NEW</b>			
						 AJYA 90EATA	 AJYA 90TATA
						 AJYA 90EATB	 AJYA 90TATB



# All Type Lineup VRF & Window, Air to Water, Deodoriser

## VRF

Capacity (kW)	15.2	22.4	28.0	33.5	40.0	45.0	50.4	55.9	61.5	67.0	73.5
HP	6	8	10	12	14	16	18	20	22	24	26
<b>J series Heat Pump</b> ▶ 076 page  AJYA 54LCLR INVERTER											
<b>S series Heat Recovery</b> ▶ 084 page  AO90MPCMF INVERTER											
<b>V series Heat Pump</b> ▶ 088 page  INVERTER											
Master		AJYA72LBTF	AJYA90LBTF		AJY126LBTF	AJYA72LBTF	AJYA90LBTF	AJYA90LBTF	AJY126LBTF	AJY126LBTF	AJYA90LBTF
Slave 1						AJYA72UBTF	AJYA72UBTF	AJYA90UBTF	AJYA72UBTF	AJYA90UBTF	AJYA72UBTF
Slave 2											AJYA72UBTF
<b>V-II series NEW Space saving Heat Pump</b> ▶ 102 page INVERTER											
Set Model		AJYA72LALH	AJYA90LALH	AJY108LALH	AJY126LALH	AJY144LALH	AJY162LALH	AJY180LALH	AJY198LALH	AJY216LALH	AJY234LALH
Unit 1		AJYA72LALH	AJYA90LALH	AJY108LALH	AJY126LALH	AJY144LALH	AJYA90LALH	AJY108LALH	AJY108LALH	AJY108LALH	AJY126LALH
Unit 2							AJYA72LALH	AJYA72LALH	AJYA90LALH	AJY108LALH	AJY108LALH
Unit 3											AJY108LALH
<b>V-II series NEW Energy efficiency Heat Pump</b> ▶ 102 page INVERTER											
Set Model						AJY144LALHH			AJY198LALHH	AJY216LALHH	AJY234LALHH
Unit 1						AJYA72LALH			AJY126LALHH	AJYA72LALH	AJYA90LALH
Unit 2						AJYA72LALH			AJYA72LALH	AJYA72LALH	AJYA72LALH
Unit 3										AJYA72LALH	AJYA72LALH



## Window

▶ 146 page

Capacity (kW)	2.8	3.5	4.6
Model Code	9	12	16
Constant  AKY9UB  AMY12UA  AFY16UA			

## Air to Water

▶ 148 page **NEW**

Capacity (kW)	5.0	6.0
Model Code	50	65
INVERTER  WSYA050DA  WSYA065DA		
Indoor unit	WSYA050DA	WSYA065DA
Outdoor unit	AOYA18LALL	AOYA18LALL



78.5 28	85.0 30	90.0 32	95.0 34	100.5 36	107.0 38	112.0 40	118.5 42	123.5 44	130.0 46	135.0 48
AJY126LBTFF	AJYA90LBTFF	AJY126LBTFF	AJY126LBTFF	AJY126LBTFF	AJY126LBTFF		AJY126LBTFF			
AJY126UBTFF	AJYA90UBTFF	AJYA90UBTFF	AJYA90UBTFF	AJY126UBTFF	AJY126UBTFF		AJY126UBTFF			
	AJYA90UBTFF	AJYA72UBTFF	AJYA90UBTFF	AJYA72UBTFF	AJYA90UBTFF		AJY126UBTFF			
AJY252LALH	AJY270LALH	AJY288LALH	AJY306LALH	AJY324LALH	AJY342LALH	AJY360LALH	AJY378LALH	AJY396LALH	AJY414LALH	AJY432LALH
AJY144LALH	AJY144LALH	AJY144LALH	AJY108LALH	AJY108LALH	AJY126LALH	AJY144LALH	AJY144LALH	AJY144LALH	AJY144LALH	AJY144LALH
AJY108LALH	AJY126LALH	AJY144LALH	AJY108LALH	AJY108LALH	AJY108LALH	AJY108LALH	AJY108LALH	AJY126LALH	AJY144LALH	AJY144LALH
			AJYA90LALH	AJY108LALH	AJY108LALH	AJY108LALH	AJY108LALH	AJY108LALH	AJY108LALH	AJY126LALH
AJY252LALHH	AJY270LALHH	AJY288LALHH	AJY306LALHH	AJY324LALHH		AJY360LALHH	AJY378LALHH	AJY396LALHH		
AJY108LALH	AJY126LALH	AJY108LALH	AJY126LALH	AJY126LALH		AJY126LALH	AJY126LALH	AJY144LALH		
AJYA72LALH	AJYA72LALH	AJY108LALH	AJY108LALH	AJY126LALH		AJY126LALH	AJY126LALH	AJY126LALH		
AJYA72LALH	AJYA72LALH	AJYA72LALH	AJYA72LALH	AJYA72LALH		AJY108LALH	AJY126LALH	AJY126LALH		

8.0 80	10.0 95	13.0 128	16.0 155
WSYA080DA	WSYA095DA	WSYA128DA	WSYA155DA
AOYA24LALL	AOYA30LBTLL	AOYA45LBTLL	AOY54LJBYL

### Deodoriser

► 154 page

Capacity (m <sup>3</sup> /h)	3.0
Model Code	30
<b>INVERTER</b>	
	DASY30S

# Split



Energy saving design to provide a comfortable indoor environment while being environment-friendly.

An air conditioner that is people-friendly is also environment-friendly. Fujitsu General offers a broad lineup of products from large living rooms to bedrooms and children's rooms. We make your room more comfortable with a wide range of air conditioner types from ceiling wall type with automatic filters and cleaning functions to wall mounted type that improve the air cleaning function. Of course these models feature highly efficient operation that conserves electricity.

## Contents

016	Ceiling Wall
018	Wall Mounted
028	Floor
030	Compact Cassette
034	Cassette
040	Floor / Ceiling
044	Ceiling
048	Compact Duct
052	Duct
056	High Static Pressure Duct

*10 types*  
*84 models*



THE INTELLIGENT CHOICE IN COMFORT



**Split type Air Conditioners**

FUJITSU GENERAL LIMITED

# INVERTER Ceiling Wall

6th year of record achievements.  
Automatic filter cleaning air conditioner



For AWYZ14 / 18LB



For AWYZ24LB

CLASS ALL  
A DC  
AWYZ14LB

CLASS ALL  
A DC  
AWYZ18LB

CLASS ALL  
A DC  
AWYZ24LB

"Vertical airflow" provides powerful floor level heating

Heating Capacity  
**No.1**

Increased heat exchange efficiency

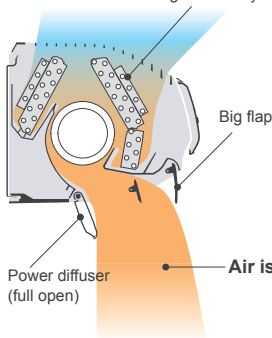

Comfortable heating area  
Approx. **2.5 times\***  
(Our company comparison)

Air is blown directly downward

"Horizontal airflow" does not blow cool air directly at the occupants in the room

Increased heat exchange efficiency

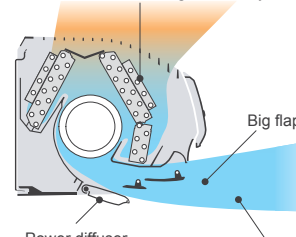

Cooling range  
Approx. **1.7 times\***  
(Our company comparison)

Blown out horizontally

\*Compared to our conventional Model ASY13PSCCW

## Specifications

Model No.	Indoor unit		AWYZ14LB	AWYZ18LB	AWYZ24LB
	Outdoor unit		AOYZ14LB	AOYZ18LB	AOYZ24LB
Power Source	V/∅/Hz		230/1/50	230/1/50	230/1/50
Capacity	Cooling	kW	4.20(0.9~5.3)	5.20(0.9~5.9)	7.10(0.9~8.0)
	Heating		6.00(0.9~9.1)	6.70(0.9~9.7)	8.50(0.9~11.0)
Input Power	Cooling/Heating	kW	1.02/1.35	1.58/1.63	2.21/2.24
EER - Energy Class	Cooling	W/W	4.12-A	3.29-A	3.21-A
COP - Energy Class	Heating		4.44-A	4.11-A	3.62-A
Running Current	Cooling/Heating	A	4.5/5.9	6.9/7.2	9.7/10.3
Moisture Removal		l/h	2.1	2.8	3.0
Noise (Indoor)	Cooling H/M/L/Q/SQ	dB(A)	46/43/35/29/24	46/43/35/29/24	47/43/40/36/32
Noise (Outdoor)	Cooling		46	47	53
Airflow Rate (High)	Indoor / Outdoor	m³/h	850/1910	850/1910	880/3600
Net Dimension H x W x D	Indoor	mm	250×899×298	250×899×298	250×899×298
		kg(lbs)	13.5(30)	13.5(30)	14(31)
	Outdoor	mm	578×790×300	578×790×300	830×900×330
		kg(lbs)	39(86)	39(86)	62(137)
Piping Connections (Small / Large)		mm	6.35/12.70	6.35/12.70	6.35/15.88
Drain Pipe Diameter (Inner/Outer)			16/29	16/29	16/29
Max Pipe Length (Chargeless)		m	20(15)	20(15)	30(15)
Max Height Difference			15	15	20
Operation Range	Cooling	°CDB	-10~43	-10~43	-10~43
	Heating		-15~24	-15~24	-15~24
Refrigerant			R410A	R410A	R410A



## Automatic filter cleaner **WORLD FIRST**<sup>\*1</sup>

- Entire filter is cleaned automatically in approx. 2 minutes.
- Since the filter is cleaned automatically, energy saving capability is displayed without regard to the load on the air conditioner.
- Energy saving CLASS A cleared with a margin to spare.
- 2 exhaustive bacteria eliminating and deodorizing countermeasures keep the air in the room clean.

### Clean & energy saving technology

- a** Dirt and dust are bacteria-eliminated by photocatalytic filter<sup>\*2</sup>
- b** Drives away bacteria and refreshes the air by UV (ultraviolet rays) illumination
- c** Energy saving by automatic filter cleaning function<sup>\*1</sup>  
This function allows an energy saving of more than 25% a year and maintains a smooth airflow by preventing the filters from being clogged with dust.
- d** Computer-designed fan provides a larger airflow than conventional models  
New air trunk, which provides a smooth airflow, and axial gap fan motor increase the max. airflow by 10% over that of conventional models.



CAE (Computer aided engineering) analysis

- e** Axial gap fan motor enables nonconventional high power and high efficiency<sup>\*3</sup>

#### Axial gap method

Rotor plates are installed above and below electromagnets.

#### Features (Compared to conventional models)

Compact size with 1.5 more power output  
Self-driven method increases rotating efficiency by 10%. Our electromagnetic field simulation technology enables low vibration and low noise.

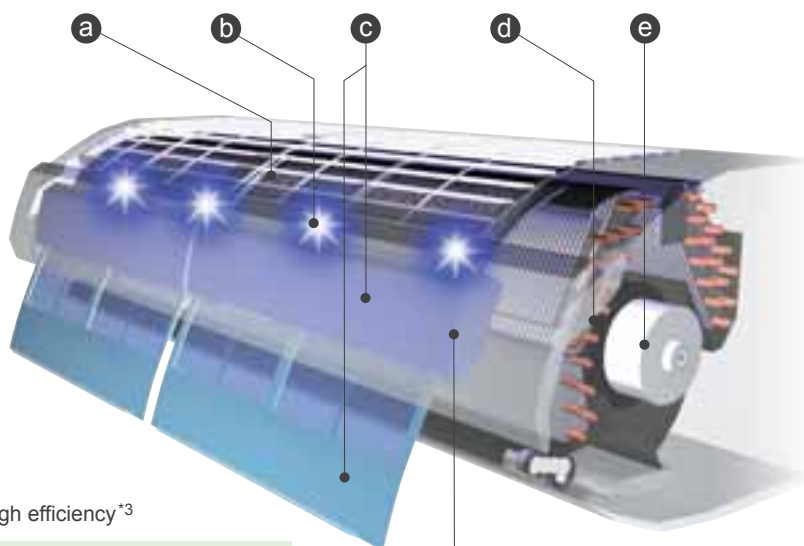
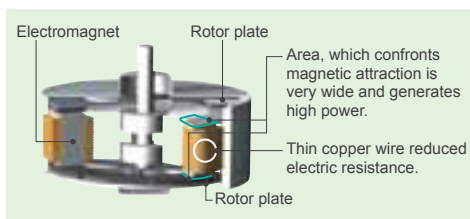

#### Antibacterial dust box

Removes dirt and dust by double brushes. Dust collection is approx. twice that in the past. (our company comparison) Maintenance: Only throwing into a trash bin once every 2 years

\*1: Announced September 9, 2002. In room air conditioner for the home (Our company's investigation) \*2: Displays double the effect of a conventional optical medium and retains its property for a long time to suck in and remove approx. 99.99% of cigarette odors and bacteria, etc. \*3: Announced December 13, 2004. As fan motor for air conditioner (Our company's investigation)

## Dimensions **Models: AWYZ14LB / AWYZ18LB / AWYZ24LB**

(Unit : mm)

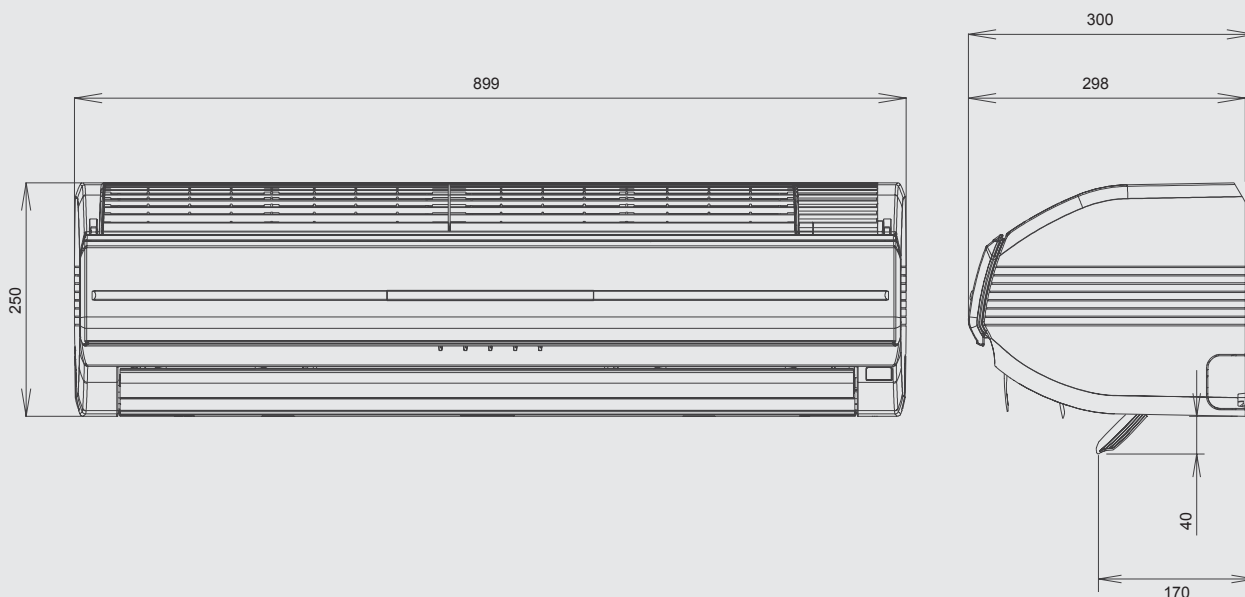

# INVERTER Wall Mounted

**PLASMA AIR CONDITIONER**

*i*-PAM (09)   V-PAM (12/18/24)(09/12/18)   Up/Down (24)   Double   Adjust   Restart   Auto Changeover   Sleep   Program   W+S   Plasma   Coil Dry   Wash

Wired R.C. (24)



**CLASS A ALL DC ASYB09LD**   **CLASS A ALL DC ASYB12LD**   **CLASS A ALL DC Heating ASYB18LD**   **CLASS A ALL DC ASYB24LD**

For ASYB09/12LD   For ASYB18/24LD

## Original plasma air cleaning unit effectively cleans the air in the room

**Plasma unit:** Mounts a plasma air cleaning unit. Minute dust particles are collected by an electrostatic filter and odor is suppressed by decomposition to foul odors by very weak ions. Since a filter with a lower ventilation resistance than in the past is used, high dust collection design simultaneously cleans the air in the room.

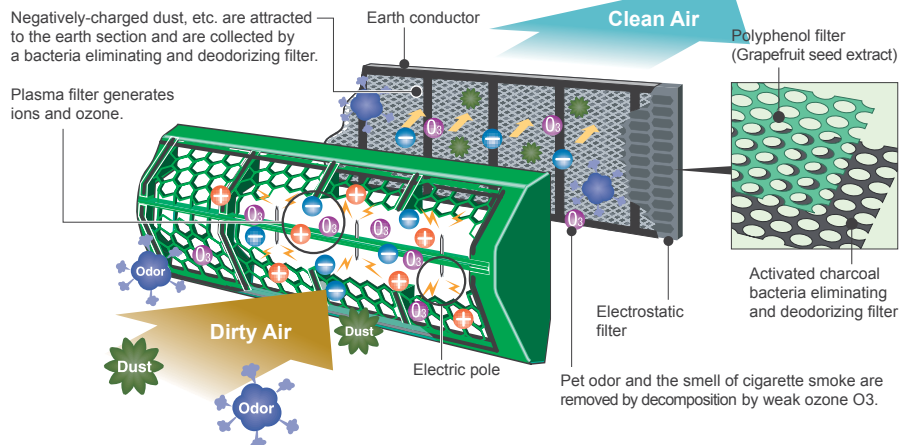

## Specifications

Model No.	Indoor unit		ASYB09LD	ASYB12LD	ASYB18LD	ASYB24LD
	Outdoor unit		AOYS09LD	AOYS12LD	AOYS18LD	AOYS24LD
Power Source		V/∅/Hz	230/1/50	230/1/50	230/1/50	230/1/50
Capacity	Cooling	kW	2.60(0.5~3.7)	3.50(0.9~4.3)	5.20 (0.9~5.7)	7.10(0.9~8.0)
	Heating		3.60(0.5~6.1)	4.80(0.9~6.7)	6.25 (0.9~9.1)	8.10(0.9~10.6)
Input Power	Cooling/Heating	kW	0.61/0.81	0.91/1.22	1.72/1.73	2.21/2.24
EER - Energy Class	Cooling	W/W	4.26-A	3.85-A	3.02-B	3.21-A
COP - Energy Class	Heating		4.44-A	3.93-A	3.61-A	3.62-A
Running Current	Cooling/Heating	A	2.9/3.9	4.3/5.5	7.6/7.7	9.7/9.8
Moisture Removal		l/h	1.3	1.8	2.8	3.0
Noise (Indoor)	Cooling	dB(A)	39/34/29/20	41/35/29/20	45/39/33/26	49/43/38/33
Noise (Outdoor)	Cooling		47	47	50	52
Airflow Rate (High)	Indoor / Outdoor	m <sup>3</sup> /h	560/1970	595/1830	700/2000	1170/2340
Net Dimension H x W x D	Indoor	mm	283x790x230	283x790x230	283x790x230	320x998x228
		kg(lbs)	9.5(21)	9.5(21)	10(22)	14(31)
	Outdoor	mm	540x790x290	540x790x290	578x790x300	578x790x315
		kg(lbs)	34(75)	36(80)	40(88)	44(97)
Piping Connections (Small / Large)		mm	6.35/9.52	6.35/9.52	6.35/12.70	6.35/15.88
Drain Pipe Diameter (Inner/Outer)			16/29	16/29	16/29	16/29
Max Pipe Length (Chargeless)		m	20(15)	20(15)	20(15)	30(15)
Max Height Difference			15	15	15	20
Operation Range	Cooling	°CDB	-10~43	-10~43	-10~43	-10~43
	Heating		-15~24	-15~24	-15~24	-15~24
Refrigerant			R410A	R410A	R410A	R410A

## Plasma air cleaner quickly removes small dust particles & odors

**Collects dirt such as...**House dust / Pet fur and dander / Cigarette smoke / Mite carcass / Mold spore / Pollen

**Absorbs odors such as...**Smell of cigarette smoke / Pet odor / Kitchen garbage smell / Perspiration and body odor

**Dust collection performance\*1**  
(ASYB09/12/18LD)

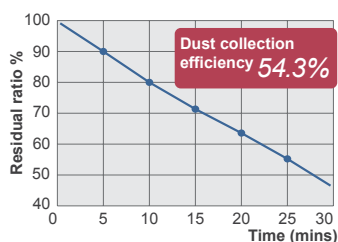

**Deodorizing performance\*2**  
(ASYB09/12/18LD)

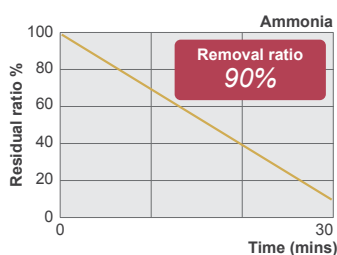
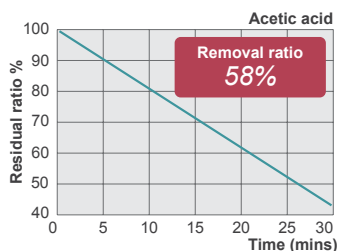

\*1. Test method: JEM 1417  
Test room: 30m<sup>3</sup>, sealed room  
Measurement conditions: Cigarette smoke (5 cigarettes burned simultaneously)

\*2. Test method: JEM1467  
Test room : 1m<sup>3</sup>, acrylic sealed box  
Measurement method: Cigarette smoke (5 cigarettes burned simultaneously)

### Bacteria elimination effect by Polyphenol ceraglaze

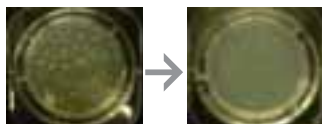

The undiluted solution of the specimen was made the specimen fluid and suspensoid 0.1ml (approx. 107CFU/ml) of the test bacteria was inoculated.

Tested by KITAZATO environment science center  
Test NO. :15-0253 Test condition: at 20 degrees C/24 hour action

## Inner drying operation & plasma effect

This model is equipped with an inner drying function. After the power is turned off, the dry operation starts inside the air conditioner. The plasma air cleaning unit eliminates bacteria, deodorizes, and keeps the interior of the air conditioner clean by generating ozone and ions.

## Easy maintenance

**Removable panel**  
ASYB09/12/18LD



**Washable filter**



## Low ambient operation

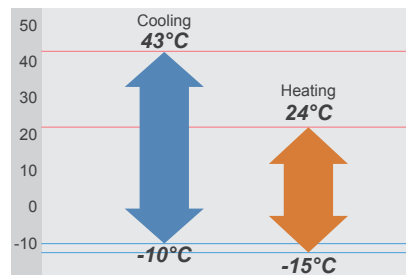

## Optional parts

Wired Remote Controller: UTB-YUD (For ASYB24LD)

External Indication Kit: UTY-XWZX (For ASYB24LD)

## Dimensions

Models: ASYB09LD / ASYB12LD / ASYB18LD / ASYB24LD

(Unit : mm)

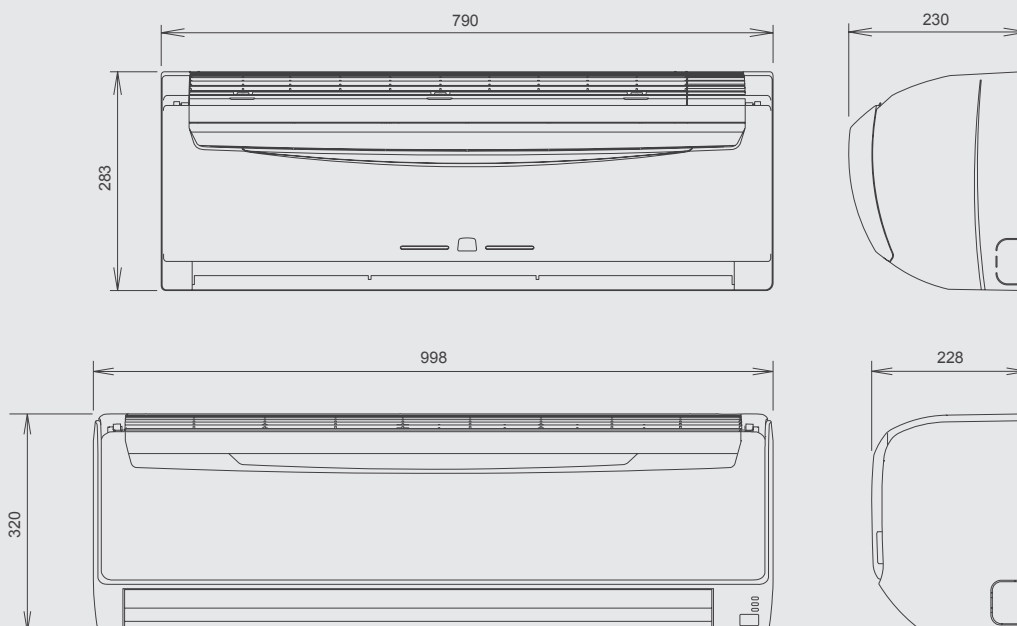

# INVERTER Wall Mounted

Simple design with energy saving.

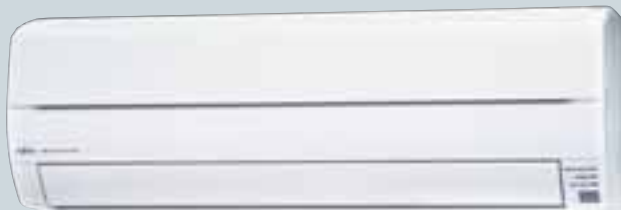

CLASS **A** ALL **DC**  
ASYA07LG

CLASS **A** ALL **DC**  
ASYA09LG

CLASS **A** ALL **DC**  
ASYA12LG

CLASS **A** ALL **DC**  
ASYA14LG

## Compact design

Indoor unit

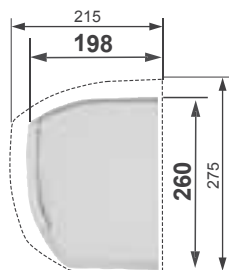

Volume **-10%**

Outdoor unit



Volume **-30%** Weight **-14%**

For ASYA12LG

----- Conventional type  
(Unit : mm)

## High density heat transfer tube arrangement

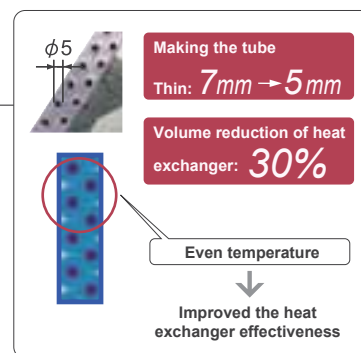

## Specifications

Model No.	Indoor unit		ASYA07LG	ASYA09LG	ASYA12LG	ASYA14LG
	Outdoor unit		AOYR07LG	AOYR09LG	AOYR12LG	AOYR14LG
Power Source	V/∅/Hz		230/1/50	230/1/50	230/1/50	230/1/50
Capacity	Cooling	kW	2.10(0.5~3.0)	2.50(0.5~3.2)	3.40(0.9~3.9)	4.00(0.9~5.0)
	Heating		3.00(0.5~4.5)	3.20(0.5~4.5)	4.00(0.9~5.6)	5.00(0.9~7.0)
Input Power	Cooling/Heating	kW	0.47/0.66	0.63/0.75	0.90/0.97	1.08/1.30
EER - Energy Class	Cooling	W/W	4.47-A	3.97-A	3.80-A	3.70-A
COP - Energy Class	Heating		4.55-A	4.27-A	4.12-A	3.86-A
Running Current	Cooling/Heating	A	2.4/3.2	3.2/3.7	4.3/4.6	4.9/5.7
Moisture Removal	l/h		1.0	1.3	1.8	2.1
Noise (Indoor)	Cooling   H/M/L/Q	dB(A)	43/38/33/21	43/39/33/21	43/39/33/21	44/40/33/25
Noise (Outdoor)	Cooling		45	45	48	48
Airflow Rate (High)	Indoor / Outdoor	m³/h	750 / 1720	750/1720	750/1830	800/2040
Net Dimension H x W x D	Indoor	mm	260x790x198	260x790x198	260x790x198	260x790x198
		kg(lbs)	7.5(17)	7.5(17)	7.5(17)	7.5(17)
	Outdoor	mm	540x660x290	540x660x290	540x660x290	620x790x298
		kg(lbs)	25(55)	25(55)	32(71)	40(88)
Piping Connections (Small / Large)	mm		6.35/9.52	6.35/9.52	6.35/9.52	6.35/12.70
Drain Pipe Diameter (Inner/Outer)	mm		16/29	16/29	16/29	16/29
Max Pipe Length (Chargeless)	m		20(15)	20(15)	20(15)	20(15)
Max Height Difference	m		15	15	15	15
Operation Range	Cooling	°CDB	-10~43	-10~43	-10~43	-10~43
	Heating		-15~24	-15~24	-15~24	-15~24
Refrigerant			R410A	R410A	R410A	R410A



## Air conditioner filter features

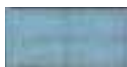

**Long-life\***  
**Ion Deodorization Filter**

The filter deodorizes by powerfully decomposing absorbed odors using the oxidizing and reducing effects of ions generated by the ultra-fine-particle ceramic.  
\*The filter can be used for approx. 3 years if it is washed under water to restore its surface action when it is dirty.



**Apple-catechin Filter**

Fine dust, invisible mold spores, and harmful microorganisms are absorbed onto the filter by static electricity, and further growth is inhibited and deactivated by the polyphenol extracted from apples.

### Deodorizing effect (Odor reduction rate)

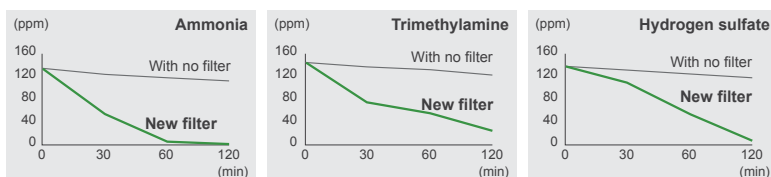

Testing organization : Environmental Sanitary Inspection Center Test method : Deodorization Test

### 10°C HEAT Operation \*Only available with Wireless RC.

The room temperature can be set to go no lower than 10°C, thus ensuring that the room does not get too cold when not occupied

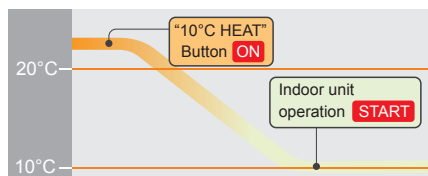

#### Caution

- When the room temperature is higher than 10°C, "10°C HEAT" operation does not start. Operation starts and maintains the room temperature at 10°C for 48 hours when the temperature drops below 10°C.
- When "10°C HEAT" operation stops, the room set temperature quickly returns to the preset temperature.

## Easy maintenance

**Removable & washable panel**



### Dry operation

Dry operation removes moisture and keeps the air conditioner clean.

## Quiet operation

Cooling mode (07/09/12TYPE)

<b>Fan speed</b> <i>Quiet</i>	<b>Noise level</b> <b>21dB<sub>(A)</sub></b>
----------------------------------	---

## Low ambient operation

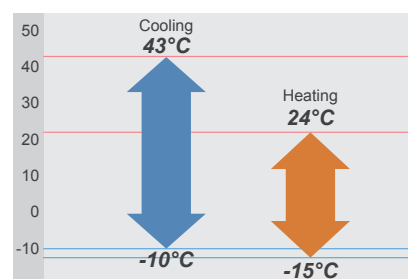

## Optional parts

- Wired Remote Controller: UTB-YUD
- Sub Interface Board: UTY-XCBXE
- External Indication Kit: UTY-XWZX

## Dimensions

Models: ASYA07LG / ASYA09LG / ASYA12LG / ASYA14LG

(Unit : mm)

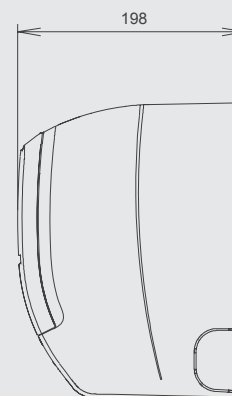
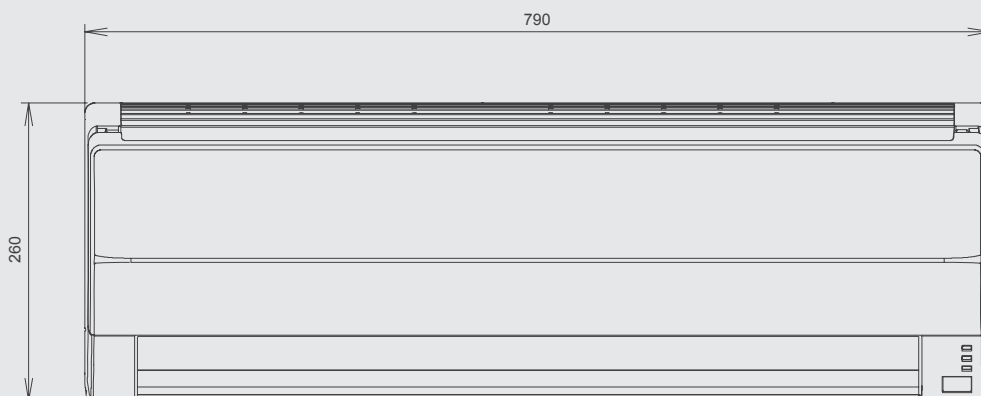

# INVERTER Wall Mounted

Simple & Elegant Appearance Design



CLASS **A** ALL **DC**

ASYA18LE

CLASS **A** ALL **DC**

ASYA24LC

ALL **DC**

ASYA30LC

  
  
 (18) (24/30)  
 Wireless R.C.

Optional

  
 Wired R.C.

  
 For ASYA18LE

  
 For ASYA24LC

  
 For ASYA30LC

V-PAM Double Adjust Restart Auto Changeover 10°C HEAT Sleep Program W+S Ion AF Coil Dry Wash

(18) Wired R.C.

“Vertical airflow” provides powerful floor level heating

Heating capacity  
**No. 1**

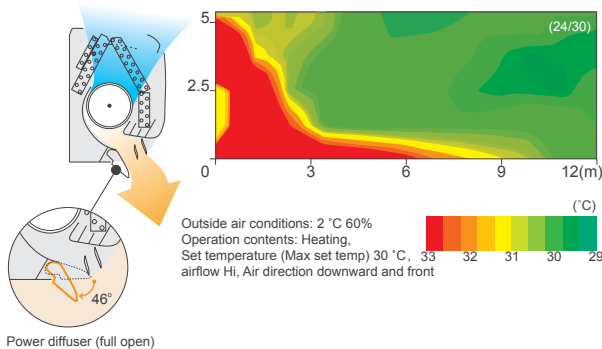

“Horizontal airflow” does not blow cool air directly at the occupants in the room

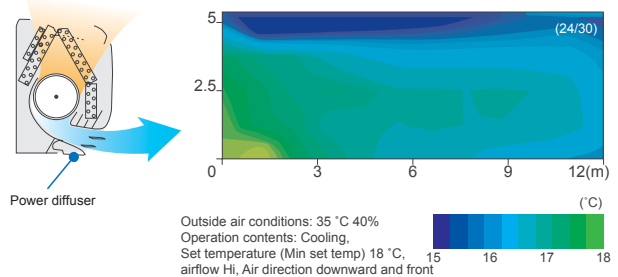

## Specifications

Model No.	Indoor unit		ASYA18LE	ASYA24LC	ASYA30LC
	Outdoor unit		AOYR18LE	AOYR24LC	AOYR30LC
Power Source	V/Ø/Hz		230/1/50	230/1/50	230/1/50
Capacity	Cooling	kW	5.20 (0.9~6.0)	7.10(0.9~8.0)	8.00(2.9~9.0)
	Heating	kW	6.30 (0.9~9.1)	8.10(0.9~10.6)	9.00(2.2~11.0)
Input Power	Cooling/Heating	kW	1.52/1.71	2.21/2.24	2.66/2.64
EER - Energy Class	Cooling	W/W	3.42-A	3.21-A	3.01-B
COP - Energy Class	Heating		3.68-A	3.62-A	3.41-B
Running Current	Cooling/Heating	A	6.8/7.6	9.7/9.8	11.7/11.6
Moisture Removal		l/h	2.8	3.0	3.4
Noise (Indoor)	Cooling	H/M/L/Q	43/37/33/26	47/41/36/32	47/41/36/32
Noise (Outdoor)	Cooling		50	52	53
Airflow Rate (High)	Indoor/Outdoor	m³/h	900/2070	1100/2340	1100/3600
Net Dimension H x W x D	Indoor	mm	320x998x228	320x998x228	320x998x228
		kg(lbs)	14(31)	14(31)	14(31)
	Outdoor	mm	620x790x298	578x790x315	830x900x330
		kg(lbs)	40(88)	44(97)	62(137)
Piping Connections (Small / Large)		mm	16/29	6.35/15.88	9.52/15.88
Drain Pipe Diameter (Inner/Outer)		mm	22.0/25.6	16/29	16/29
Max Pipe Length (Chargeless)		m	25(15)	30(15)	50(20)
Height Difference			20	20	30
Operation Range	Cooling	°CDB	-10~43	-10~43	-10~43
	Heating		-15~24	-15~24	-15~24
Refrigerant			R410A	R410A	R410A

### Air conditioner filter features

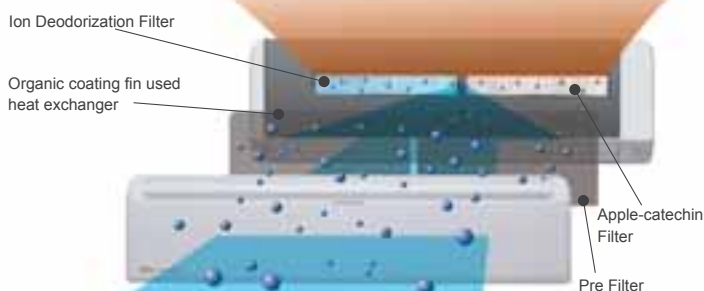

Antibacterial deodorizing pre-filter with special ceramic powder



**Long-life\* Ion Deodorization Filter**

The filter deodorizes by powerfully decomposing absorbed odors using the oxidizing and reducing effects of ions generated by the ultra-fine-particle ceramic.

(\*The filter can be used for approx. 3 years if it is washed under water to restore its surface action when it is dirty.)

+ Using different filters at both sides

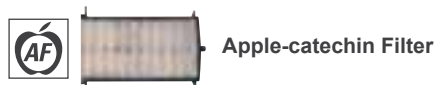

**Apple-catechin Filter**

Fine dust, invisible mold spores, and harmful microorganisms are absorbed onto the filter by static electricity, and further growth is inhibited and deactivated by the polyphenol extracted from apples.

### Flexible Installation

	18 type	24 type	30 type
Max. Piping Length	25m	30m	50m
Max. Height	20m	20m	30m

### Easy maintenance

Simplification of drain pan cleaning improves maintenance-ability.

### Low ambient operation

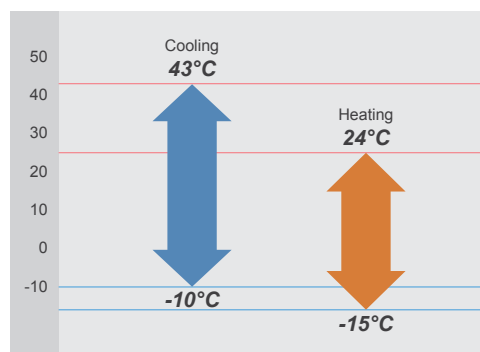

### Optional parts

Wired Remote Controller: UTB-YUD  
 External Indication Kit: UTY-XWZX

### Dimensions

Models: ASYA18LE / ASYA24LC / ASYA30LC

(Unit : mm)

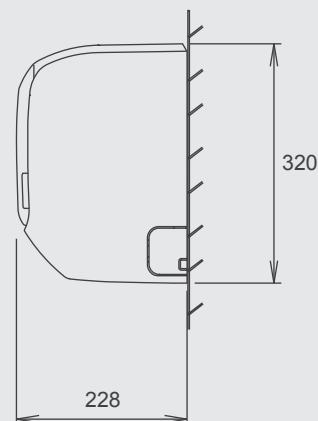
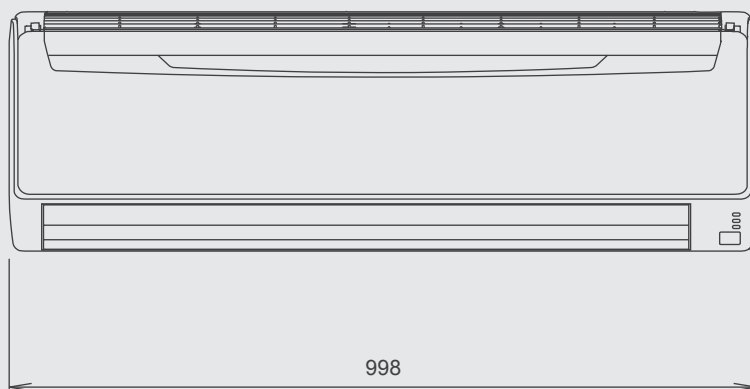

# Wall Mounted













Optional

For ASY7UB/9UC      For ASY12UC

**ASY7UB ASY9UC ASY12UC**













Optional

For ASY14UB

**ASY14UB**

## Specifications

Model No.	Indoor unit		ASY7UB	ASY9UC	ASY12UC	ASY14UB
	Outdoor unit		AOY7UB	AOY9UC	AOY12UC	AOY14UB
Power Source		V/∅/Hz	230/1/50	230/1/50	230/1/50	230/1/50
Capacity	Cooling	kW	2.20	2.60	3.25	4.25
	Heating		2.30	2.95	3.95	4.80
Input Power	Cooling/Heating	kW	0.83/0.75	1.07/0.90	1.35/1.28	1.38/1.27
EER - Energy Class	Cooling	W/W	2.65-D	2.43-E	2.41-E	3.08-B
COP - Energy Class	Heating		3.07-D	3.28-C	3.09-D	3.78-A
Running Current	Cooling/Heating	A	3.9/3.6	4.8/4.1	5.9/5.6	6.1/5.6
Moisture Removal		l/h	1.0	1.3	1.8	2.0
Noise (Indoor)	Cooling   H/M/L/Q	dB(A)	38/35/33/29	40/38/35/30	40/38/36/33	43/40/37/33
Noise (Outdoor)	Cooling		43	46	48	47
Airflow Rate (High)	Indoor / Outdoor	m³/h	380/1350	540/1350	540/1700	700/1670
Net Dimension H x W x D	Indoor	mm	257x808x187	257x808x187	257x808x187	275x790x215
		kg(lbs)	8(18)	8(18)	8(18)	9(20)
	Outdoor	mm	535x650x250	535x650x250	535x650x250	535x780x250
		kg(lbs)	26(57)	28(62)	31(68)	37(82)
Piping Connections (Small / Large)		mm	6.35/9.52	6.35/9.52	6.35/9.52	6.35/12.7
Drain Pipe Diameter (Inner/Outer)		mm	14/25.5	14/25.5	14/25.5	14/25.5
Max Pipe Length (Chargeless)		m	10(7.5)	15(7.5)	15(7.5)	15(7.5)
Max Height Difference			5	8	8	8
Operation Range	Cooling	°C	21~43	21~43	21~43	21~43
	Heating		-15~24	-15~24	-15~24	-15~24
Refrigerant			R410A	R410A	R410A	R410A

### Powerful output in spite of small size

Though the indoor unit is compact, it features a large, high pressure cross fan (90mm diameter) in a center mounted configuration and a lambda type heat exchanger to provide plenty of power. The extra long diffuser provides a wide outflow opening for air. This ensures a large air outflow volume over a wide area to cool or heat all areas of the room.



### Auto swing louver

6-step air directions by auto swing louver.

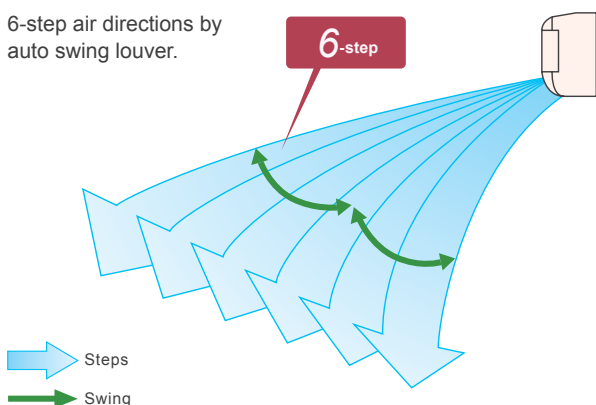

### Symmetrical design

Symmetrical, clean design that suits all interiors.



### Easy maintenance

Easy maintenance has been realized as the front panel can be removed for easy access.



#### Handy type remote controller

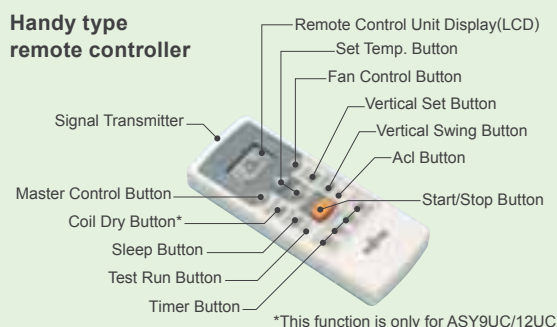

\*This function is only for ASY9UC/12UC

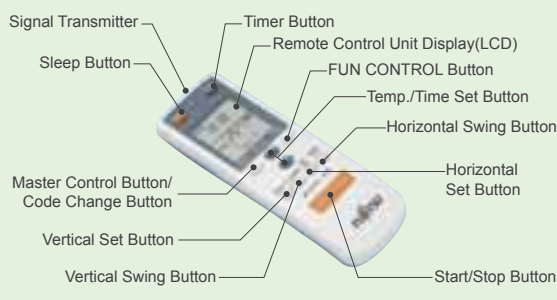

### Dimensions

Models: ASY7UB / ASY9UC / ASY12UC / ASY14UB

(Unit : mm)

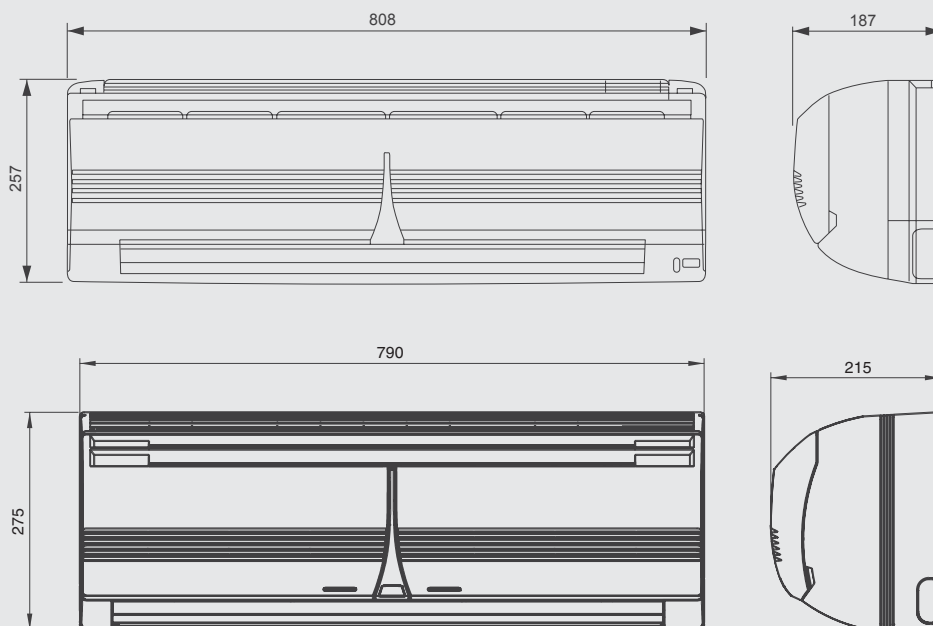



# Wall Mounted



## Powerful output in spite of small size

Though the indoor unit is compact, it features a large, high pressure cross fan (107mm diameter) in a center mounted configuration and a lambda type heat exchanger to provide plenty of power. The extra long diffuser provides a wide outflow opening for air. This ensures a large air outflow volume over a wide area to cool or heat all areas of the room.



## Specifications

Model No.	Indoor unit		ASY18UB	ASY24UB	ASY30UB
	Outdoor unit		AOY18UB	AOY24UB	AOY30UB
Power Source	V/Ø/Hz		230/1/50	230/1/50	230/1/50
Capacity	Cooling	kW	5.40	6.80	7.90
	Heating		5.70	7.40	8.40
Input Power	Cooling/Heating		1.85/1.85	2.40/2.40	2.75/2.75
EER - Energy Class	Cooling	W/W	2.92-C	2.83-C	2.87-C
COP - Energy Class	Heating		3.08-D	3.08-D	3.05-D
Running Current	Cooling/Heating		8.3/8.3	10.6/10.5	13.0/13.0
Moisture Removal			2.0	2.5	3.0
Noise (Indoor)	Cooling	H/M/L dB(A)	41/37.5/34	45/42/38	47.5/44/40.5
Noise (Outdoor)	Cooling		52	53	54
Airflow Rate (High)	Indoor/Outdoor		800/3200	970/3200	1040/3320
Net Dimension H x W x D	Indoor	mm	320x1120x220	320x1120x220	320x1120x220
		kg(lbs)	16(35)	16(35)	16(35)
	Outdoor	mm	650x830x320	650x830x320	900x900x350
		kg(lbs)	52(114)	59(130)	74(163)
Piping Connections (Small / Large)			6.35/15.88	9.52/15.88	9.52/15.88
Drain Pipe Diameter (Inner/Outer)			16/28	16/28	16/28
Max Pipe Length (Chargeless)			20(7.5)	20(7.5)	25(7.5)
Height Difference			8	8	15
Operation Range	Cooling	°CDB	0~43	0~43	0~43
	Heating		-6~24	-6~24	-6~24
Refrigerant			R410A	R410A	R410A

## Multi airflow

Large independently driven power diffuser used

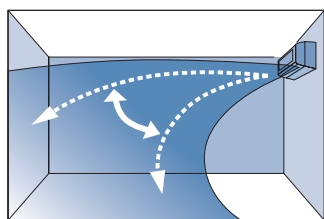

Cooling

Horizontal concentration and other air direction control

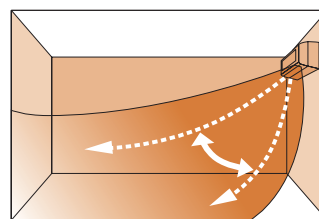

Heating

Wide down flow

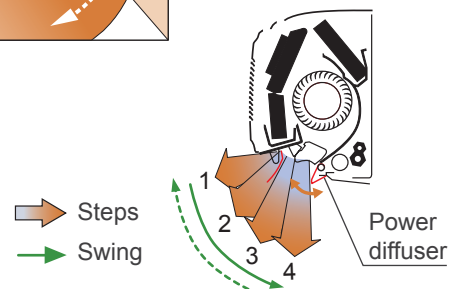
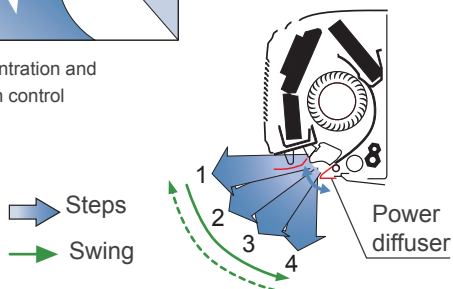

## Low noise

- High efficiency fan construction ⇒ ø7mm Lambda type evaporator improves the airflow path
- Large independently driven power diffuser

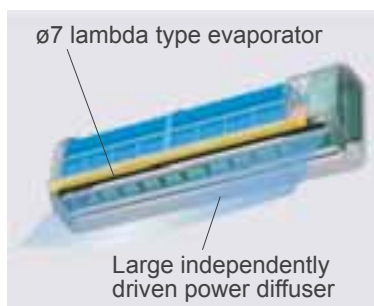

Low noise  
**33** dB  
(ASY18)

## Easy installation

Expanded work space at bottom of casing increases piping space by 15%.

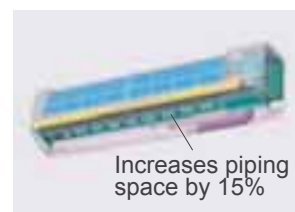

## Others

- Double auto swing
- 2-way draining route

## Dimensions

Models: ASY18UB / ASY24UB / ASY30UB

(Unit : mm)

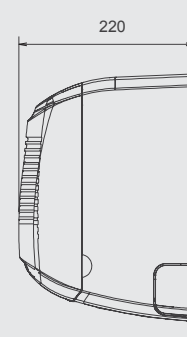
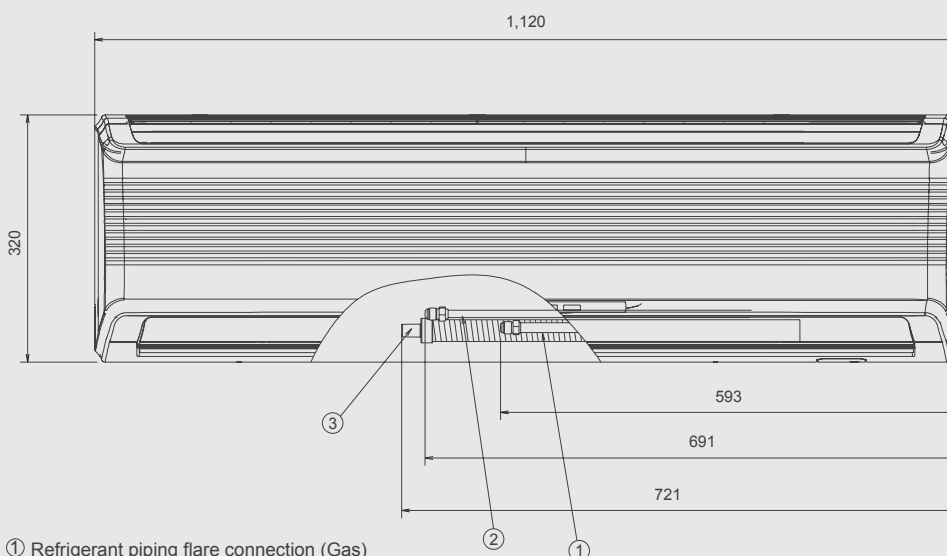

- ① Refrigerant piping flare connection (Gas)
- ② Refrigerant piping flare connection (Liquid)
- ③ Drain piping connection

## Floor

Simple & Thin design harmonizes with the interior

Wired R.C.

Optional  
Wired R.C.

For AGYF09/12LA      For AGYF14LA

**CLASS A ALL DC**      **CLASS A ALL DC**      **CLASS A ALL DC**  
**AGYF09LA**      **AGYF12LA**      **AGYF14LA**

### Flexible & easy installation

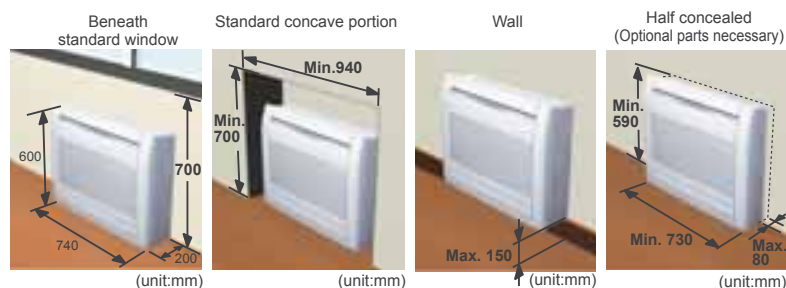

### 2-Fan & Wide airflow

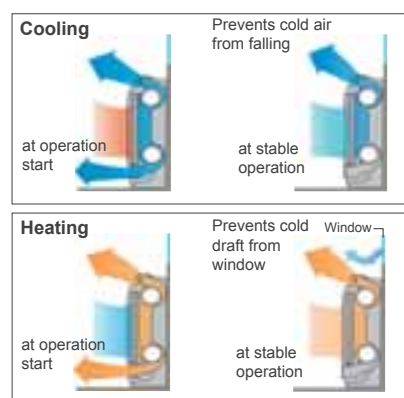

### Specifications

Model No.	Indoor unit		AGYF09LA	AGYF12LA	AGYF14LA
	Outdoor unit		AOYV09LA	AOYV12LA	AOYV14LA
Power Source	V/Ø/Hz		230/1/50	230/1/50	230/1/50
Capacity	Cooling	kW	2.60(0.9~3.5)	3.50(0.9~4.0)	4.20(0.9~5.0)
	Heating	kW	3.50(0.9~5.5)	4.50(0.9~6.6)	5.20(0.9~8.0)
Input Power	Cooling/Heating	kW	0.53/0.79	0.94/1.19	1.14/1.44
EER - Energy Class	Cooling	W/W	4.91-A	3.72-A	3.68-A
COP - Energy Class	Heating		4.43-A	3.78-A	3.61-A
Running Current	Cooling/Heating	A	2.6/3.8	4.4/5.5	5.2/6.4
Moisture Removal		l/h	1.3	1.8	2.1
Noise (Indoor)	Cooling	H/M/L/Q	40/35/29/22	40/35/29/22	44/38/31/22
Noise (Outdoor)	Cooling		47	48	50
Airflow Rate (High)	Indoor/Outdoor	m³/h	570/1680	570/1680	650/1910
Net Dimension H x W x D	Indoor	mm	600x740x200	600x740x200	600x740x200
		kg(lbs)	14(31)	14(31)	14(31)
	Outdoor	mm	540x790x290	540x790x290	578x790x300
		kg(lbs)	36(79)	36(79)	40(88)
Piping Connections (Small / Large)		mm	6.35/9.52	6.35/9.52	6.35/12.7
Drain Pipe Diameter (Inner/Outer)		mm	16/29	16/29	16/29
Max Pipe Length (Chargeless)		m	20(15)	20(15)	20(15)
Height Difference			15	15	15
Operation Range	Cooling	°CDB	-10~43	-10~43	-10~43
	Heating	°CDB	-15~24	-15~24	-15~24
Refrigerant			R410A	R410A	R410A

## Filter features



### Long-life\* Ion Deodorization Filter

The filter deodorizes by powerfully decomposing absorbed odors using the oxidizing and reducing effects of ions generated by the ultra-fine-particle ceramic.  
 (\*The filter can be used for approx. 3 years if it is washed under water to restore its surface action when it is dirty.)

✚ Using different filters at both sides

### Apple-catechin Filter

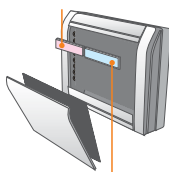

### Apple-catechin Filter

Fine dust, invisible mold spores, and harmful microorganisms are absorbed onto the filter by static electricity, and further growth is inhibited and deactivated by the polyphenol extracted from apples.

### Ion Deodorization Filter

## 10°C HEAT Operation

The room temperature can be set to go no lower than 10°C, thus ensuring that the room does not get too cold when not occupied

Caution)

- When the room temperature is higher than 10°C, "10°C HEAT" operation does not start. Operation starts and maintains the room temperature at 10°C for 48 hours when the temperature drops below 10°C.
- When "10°C HEAT" operation stops, the room set temperature quickly returns to the preset temperature.

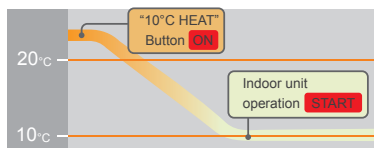

## Easy maintenance

Washable panel removable

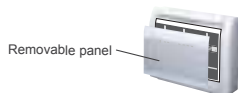

## Flexible piping connection 6 direction of drain & piping

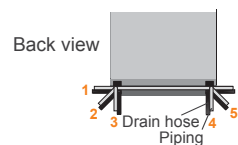

## Low ambient operation

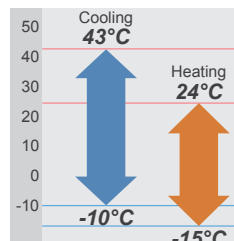

## Quiet operation

Industry leading noise levels



## Optional parts

- Wired Remote Controller: UTB-YUD
- Half Concealed Kit: UTR-STA
- External Indication Kit: UTY-XWZX

## Dimensions

Models: AGYF09LA / AGYF12LA / AGYF14LA

(Unit : mm)

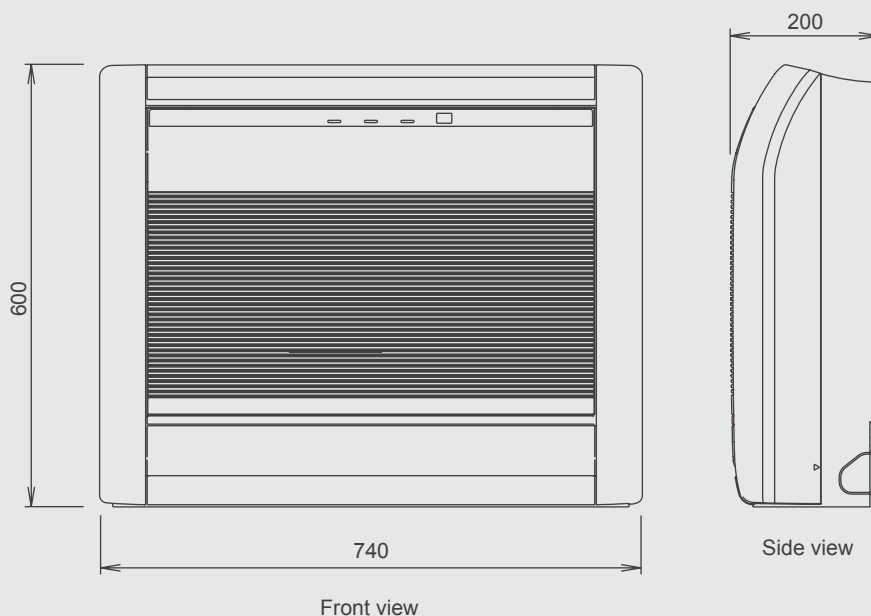

# Compact Cassette

Powerful wide air flow & Quiet operation

Wired R.C. Optional (18/24) (12/14/18)

Grille is an option

Wireless R.C.

Optional Wired R.C.

Compact Outdoor Unit

<b>CLASS A</b> <b>ALL DC</b>	<b>CLASS A</b> <b>ALL DC</b>	<b>CLASS A</b> <b>ALL DC</b>	<b>CLASS A</b> <b>ALL DC</b>
<b>AUYF12LA</b>	<b>AUYF14LA</b>	<b>AUYF18LB</b>	<b>AUYF24LB</b>

## 2-stage turbo fan

High efficiency design by 2 stage structure

**Wind velocity**

Fast

Slow

**Previous turbo fan**

In the case of a conventional fan, the air outlet range was narrow as the airflow moved to the motor side which meant the velocity of air passing through the heat exchanger was uneven.

➔

**2-stage turbo fan**

A evenly spread air distribution across the heat exchanger is possible due to the new 2 stage turbo fan which produces two separate airflow streams.

Heat exchange efficiency: **20%UP**

## Quiet quality

Optimization of wing form (laminar wing type) and wing number (7 blades each)

Designed by CFD-analysis (fluid) simulations

Laminar wing

Airflow runs through smoothly along the laminar wing

No airflow separation

**Quiet**

Adoption of laminar wing

Spin direction ← Airflow direction →

## Specifications

Model No.	Indoor unit		AUYF12LA	AUYF14LA	AUYF18LB	AUYF24LB
	Outdoor unit		AOYA12LA	AOYA14LA	AOYA18LA	AOYA24LA
Power Source	V/Ø/Hz		230/1/50	230/1/50	230/1/50	230/1/50
Capacity	Cooling	kW	3.50	4.30	5.20	7.10
	Heating	kW	4.10	5.00	6.00	8.00
Input Power	Cooling/Heating	kW	1.05/1.11	1.33/1.34	1.62/1.66	2.21/2.21
EER - Energy Class	Cooling	W/W	3.33-A	3.21-A	3.21-A	3.21-A
COP - Energy Class	Heating		3.69-A	3.71-A	3.61-A	3.61-A
Running Current	Cooling/Heating	A	4.6/4.9	5.8/5.9	7.1/7.3	9.7/9.7
Moisture Removal		l/h	1.2	1.5	2.2	2.7
Noise (Indoor)	Cooling	H/M/L/Q	37/34/30/27	38/34/30/27	38/34/30/26	49/44/36/30
Noise (Outdoor)	Cooling		47	49	50	52
Airflow Rate (High)	Indoor/Outdoor	m³/h	600/1780	680/1910	680/2000	930/2470
Net Dimension H x W x D	Indoor / Grille	mm	245×570×570/ 50×700×700	245×570×570/ 50×700×700	245×570×570/ 50×700×700	245×570×570/ 50×700×700
		kg(lbs)	15(33)/2.6(6)	15(33)/2.6(6)	15(33)/2.6(6)	17(37)/2.6(6)
	Outdoor	mm	578×790×300	578×790×300	578×790×300	578×790×315
		kg(lbs)	40(88)	40(88)	40(88)	44(97)
Piping Connections (Small / Large)		mm	6.35/9.52	6.35/12.70	6.35/12.70	6.35/15.88
Drain Pipe Diameter (Inner/Outer)		mm	19.4/25.4	19.4/25.4	19.4/25.4	19.4/25.4
Max Pipe Length (Chargeless)		m	25	25	25	30
Height Difference		m	15	15	15	20
Operation Range	Cooling	°CDB	-10~46	-10~46	-10~46	-10~46
	Heating	°CDB	-15~24	-15~24	-15~24	-15~24
Refrigerant			R410A	R410A	R410A	R410A
Grille			UTG-UFYB-W	UTG-UFYB-W	UTG-UFYB-W	UTG-UFYB-W



## Easy maintenance

### 1 Maintenance of fan motor and fan

Maintenance of the fan motor and fan can be done easily after taking off the panel as the bell mouth of the fan can be removed easily.

A : Fan motor B : 2-stage turbo fan  
C : Bell-mouth D : Panel



### 2 Long life filter

: standard equipment

### 3 Adaptation of transparent drainage parts

During installation, maintenance and operation, the drain pump and kit can be checked easily.

## High lift drain pump

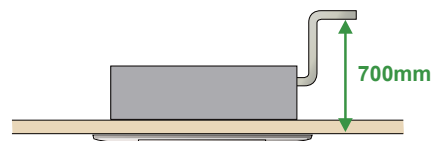

## Low ambient operation

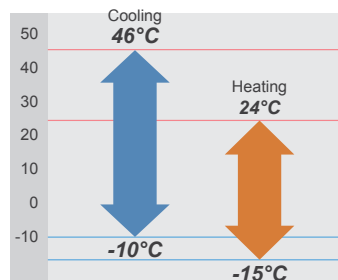

## Compact design

Worlds first 24,000Btu model in the compact cassette category  
(Easy installation by taking off ceiling panel of 600 x 600 size)



## Optional parts

Air Outlet Shutter Plate: UTR-YDZB  
Wired Remote Controller: UTB-YUD  
Insulation Kit For High Humidity: UTZ-KXGC

## Dimensions

Models: AUYP12LA / AUYP14LA / AUYP18LB / AUYP24LB

(Unit : mm)

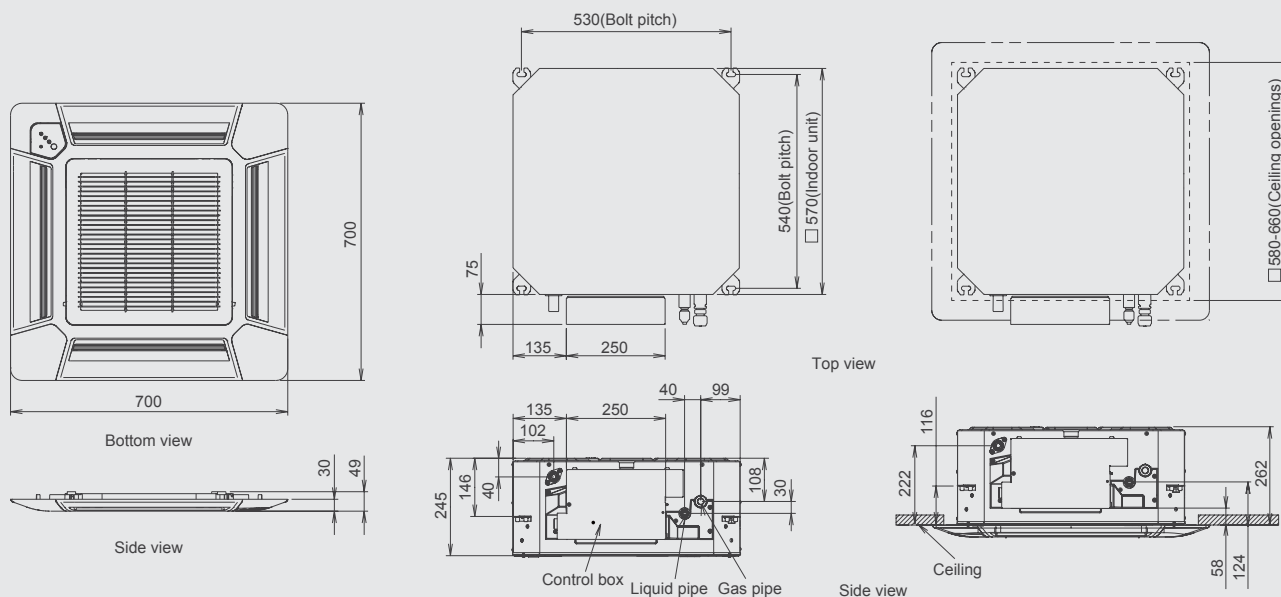

# Compact Cassette

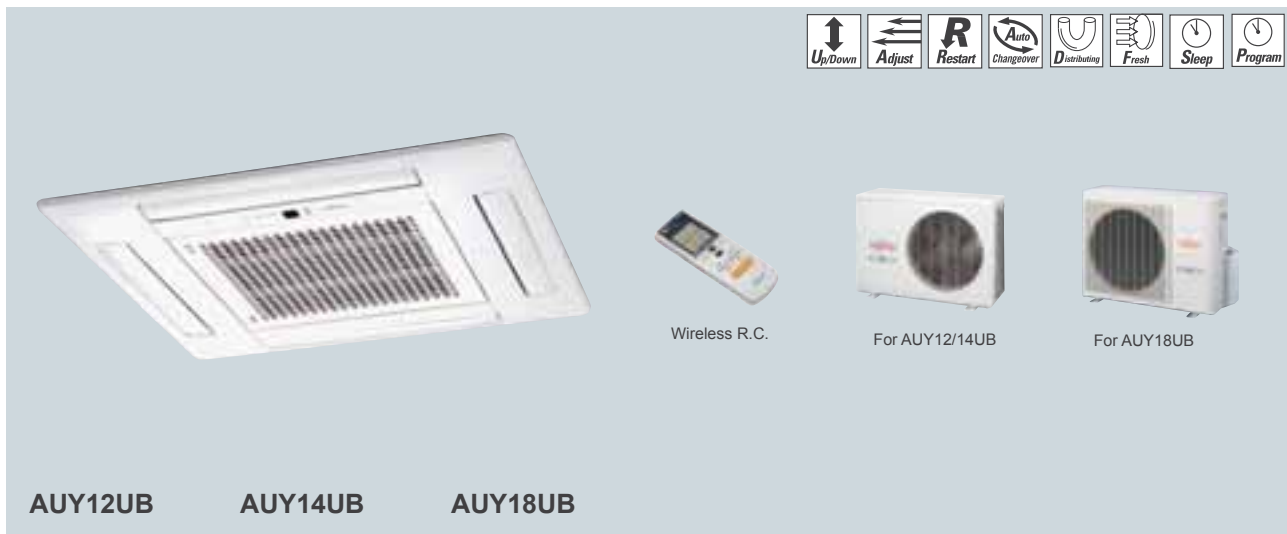

## Comfortable air flow

### 4 step swing

Auto air flow direction and auto swing

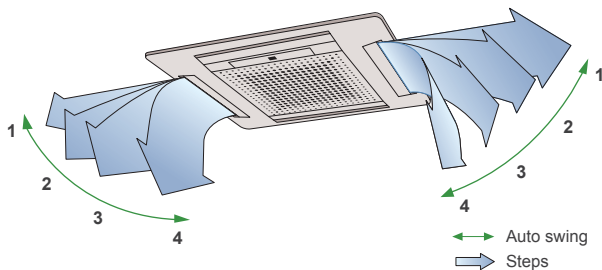

### 2-4 way air flow system

Select 2-way, 3-way or 4-way air flow to suit your needs.

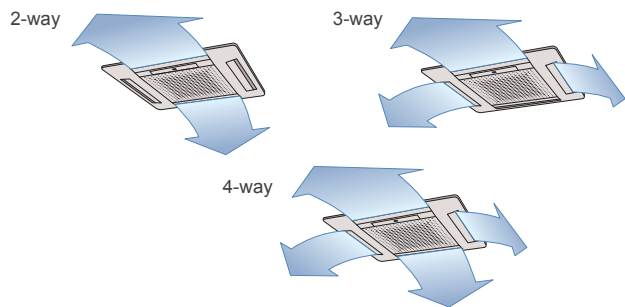

## Specifications

Model No.	Indoor unit		AUU12UB	AUU14UB	AUU18UB	
	Outdoor unit		AOU12UB	AOU14UB	AOU18UB	
Power Source	V/Ø/Hz		230/1/50	230/1/50	230/1/50	
Capacity	Cooling	kW	3.55	3.95	4.85	
	Heating		4.00	4.60	5.40	
Input Power	Cooling/Heating		1.24/1.21	1.40/1.42	1.85/2.00	
EER - Energy Class	Cooling	W/W	2.86-C	2.82-C	2.62-D	
COP - Energy Class	Heating		3.31-C	3.24-C	2.70-E	
Running Current	Cooling/Heating		5.5/5.4	6.3/6.3	8.2/9.2	
Moisture Removal			1.3	1.5	2.1	
Noise (Indoor)	Cooling	H/M/L	42/39/36	42/39/36	44/41/37	
Noise (Outdoor)	Cooling					
Airflow Rate (High)	Indoor/Outdoor		m <sup>3</sup> /h	550/1600	550/1600	620/3200
Net Dimension H x W x D	Indoor / Grille	mm	235x580x580	235x580x580	235x580x580	
		kg(lbs)	18(40)	18(40)	18(40)	
	Outdoor	mm	530x750x250	530x750x250	650x830x320	
		kg(lbs)	34(75)	35(77)	52(115)	
Piping Connections (Small / Large)			6.35/9.52	6.35/12.70	6.35/12.70	
Max Pipe Length (Chargeless)			20	20	20	
Height Difference			8	8	8	
Operation Range	Cooling	°CDB	0~43	0~43	0~43	
	Heating		-7~24	-7~24	-7~24	
Refrigerant			R410A	R410A	R410A	
Grille			UTG-UDYD-W	UTG-UDYD-W	UTG-UDYD-W	

### Duct connection hole opening

Fresh air can be introduced through this opening

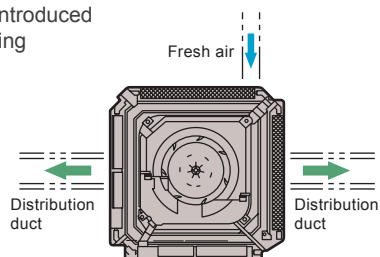

Conditioned air can be distributed by means of a distribution duct

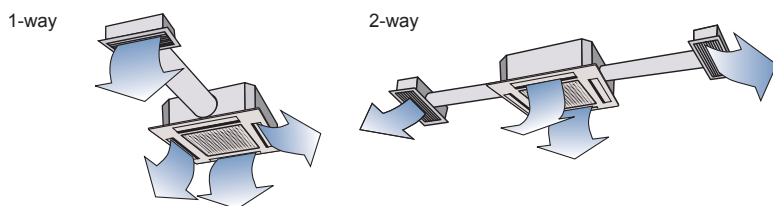

### Compact size

Compact grille fits European ceiling panel (650 x 650 mm)

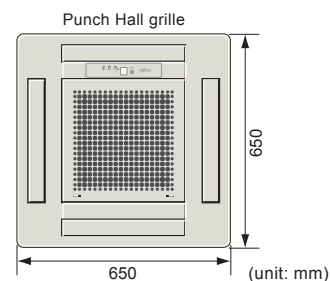

Condensate pump lift to 400mm

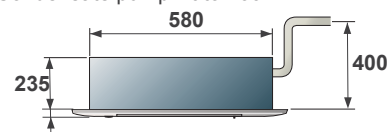

### Additional grille (optional parts)

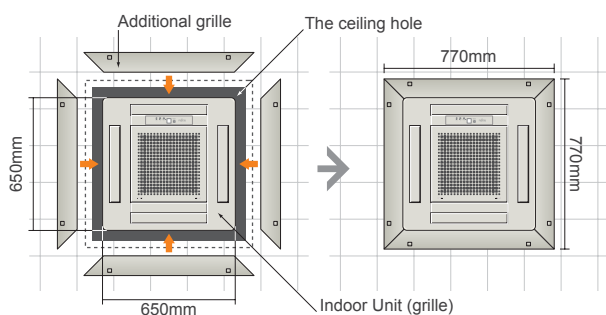

### Optional parts

Additional Grille: UTG-AGDA-W

### Dimensions

Models: AUY12UB / AUY14UB / AUY18UB

(Unit : mm)

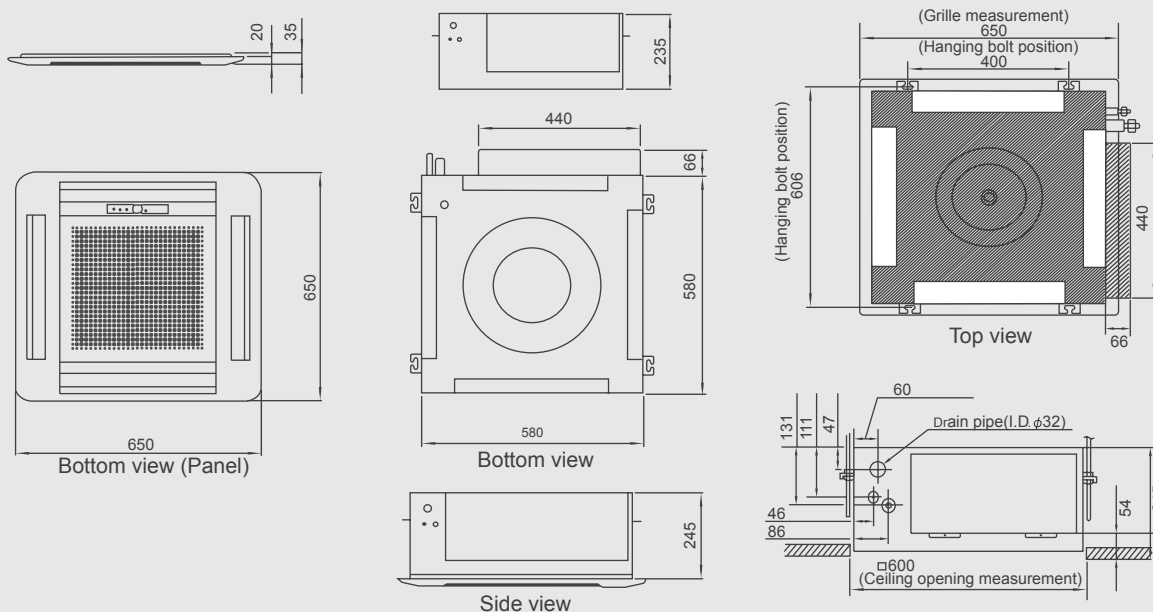

# INVERTER Cassette

Powerful wide air flow & Quiet operation



Grille is an option



Wired R.C.



Optional  
IR Receiver Kit



For AUYA30/36LB



For AUYA45LC  
(For single phase)



For AUYA36/45/54LC  
(For 3 phase)

CLASS **A** ALL **DC**

**AUYA30LB**

CLASS **A** ALL **DC**

**AUYA36LB**  
**AUYA36LC** NEW

CLASS **A** ALL **DC**

**AUYA45LC** NEW

CLASS **A** ALL **DC**

**AUYA54LC** NEW

Wireless R.C.  
Optional



## High efficiency turbo fan with 3-dimensional blade

**Previous turbo fan:** Air passing through the heat exchanger was uneven and the air would only flow close to the ceiling.

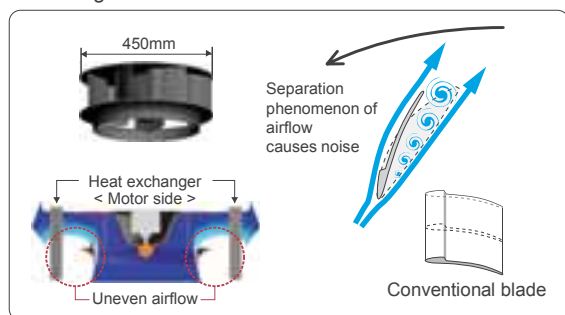

**New turbo fan:** High efficiency airflow distribution has been achieved by the introduction of a 3 dimensional blade which increases the air passing over the heat exchanger.

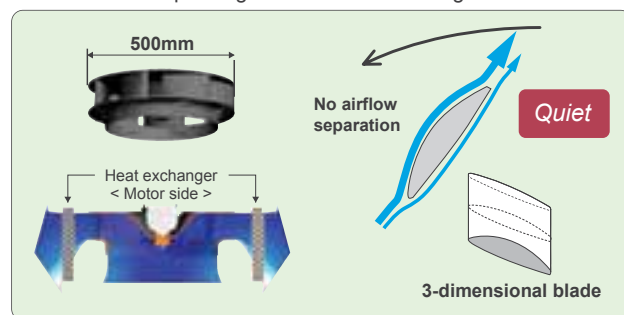

← Spin direction    → Airflow direction    ••••• Turbulent flow noise

## Specifications

Model No.	Indoor unit		AUYA30LB	AUYA36LB	AUYA36LC	AUYA45LC	AUYA45LC	AUYA54LC
	Outdoor unit		AOYA30LB	AOYA36LB	AOYD36LA	AOYA45LB	AOYD45LA	AOYD54LA
Power Source	V/∅/Hz		230/1/50	230/1/50	400/3/50	230/1/50	400/3/50	400/3/50
Capacity	Cooling	kW	8.50	10.00	10.00	12.50	12.50	14.00
	Heating	kW	10.00	11.20	11.20	14.00	14.00	16.00
Input Power	Cooling/Heating	kW	2.65/2.77	3.11/3.02	2.44/2.56	3.89/3.77	3.54/3.58	4.36/4.43
EER - Energy Class	Cooling	W/W	3.21-A	3.21-A	4.10-A	3.21-A	3.53-A	3.21-A
COP - Energy Class	Heating	W/W	3.61-A	3.71-A	4.38-A	3.71-A	3.91-A	3.61-A
Running Current	Cooling/Heating	A	11.6/12.2	13.7/13.3	3.7/3.9	17.0/16.5	5.3/5.3	6.5/6.6
Moisture Removal		l/h	2.5	3.0	3.0	5.0	4.5	5.0
Noise (Indoor)	Cooling   H/M/L/Q	dB(A)	40/38/36/32	43/38/36/32	44/39/36/33	46/42/40/36	46/42/40/36	47/43/41/37
Noise (Outdoor)	Cooling		54	54	51	55	54	55
Airflow Rate (High)	Indoor / Outdoor	m³/h	1600/3600	1800/4000	1800/6200	1900/6600	1900/6900	2000/6900
Net Dimension H x W x D	Indoor / Grille	mm	288x840x840 50x950x950	288x840x840 50x950x950	288x840x840 50x950x950	288x840x840/ 50x950x950	288x840x840 50x950x950	288x840x840 50x950x950
		kg(lbs)	26(57)/5.5(12)	26(57)/5.5(12)	27(60)/5.5(12)	27(60)/5.5(12)	27(60)/5.5(12)	27(60)/5.5(12)
	Outdoor	mm	830x900x330	830x900x330	1290x900x330	1290x900x330	1290x900x330	1290x900x330
		kg(lbs)	62(137)	62(137)	107(236)	98(216)	107(236)	107(236)
Piping Connections (Small / Large)		mm	9.52/15.88	9.52/15.88	9.52/15.88	9.52/15.88	9.52/15.88	9.52/15.88
Drain Pipe Diameter (Inner/Outer)		mm	25.0/32.0	25.0/32.0	25.0/32.0	25.0/32.0	25.0/32.0	25.0/32.0
Max Pipe Length (Chargeless)		m	50	50	75	50	75	75
Height Difference			30	30	30	30	30	30
Operation Range	Cooling	°CDB	-15~46	-15~46	-15~46	-15~46	-15~46	-15~46
	Heating		-15~24	-15~24	-15~24	-15~24	-15~24	-15~24
Refrigerant			R410A	R410A	R410A	R410A	R410A	
Grille			UTG-UGYA-W	UTG-UGYA-W	UTG-UGYA-W	UTG-UGYA-W	UTG-UGYA-W	

### Improvement of the airflow distribution

**New louvre:** The louvre design distributes air leaving a space between the chassis and the ceiling allowing far and wide air flow distribution.

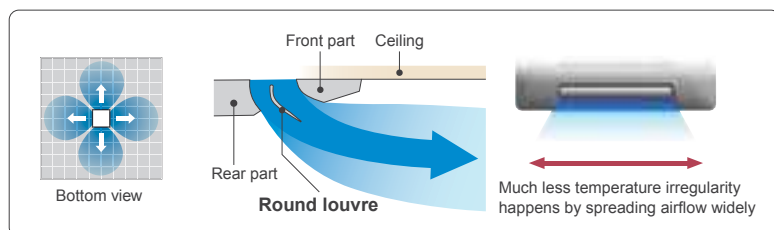

### Adjustment of hanger position is possible after installation

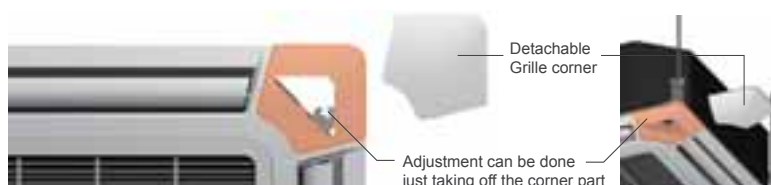

### High lift drain pump



### Low ambient operation

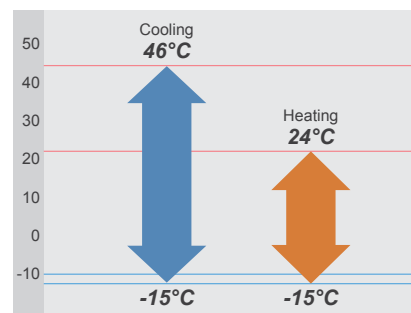

### One way aperture installation

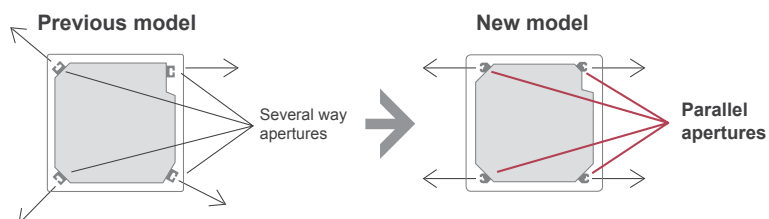

### Optional parts

IR Receiver Kit:	UTY-LRHYA1
Wide Panel:	UTG-AGYA-W
Panel Spacer:	UTG-BGYA-W
Air Outlet Shutter Plate:	UTR-YDZC
Insulation Kit For High Humidity:	UTZ-KXGA

## Dimensions

Models: AUYA30LB / AUYA36LB / AUYA36LC / AUYA45LC / AUYA54LC

(Unit : mm)

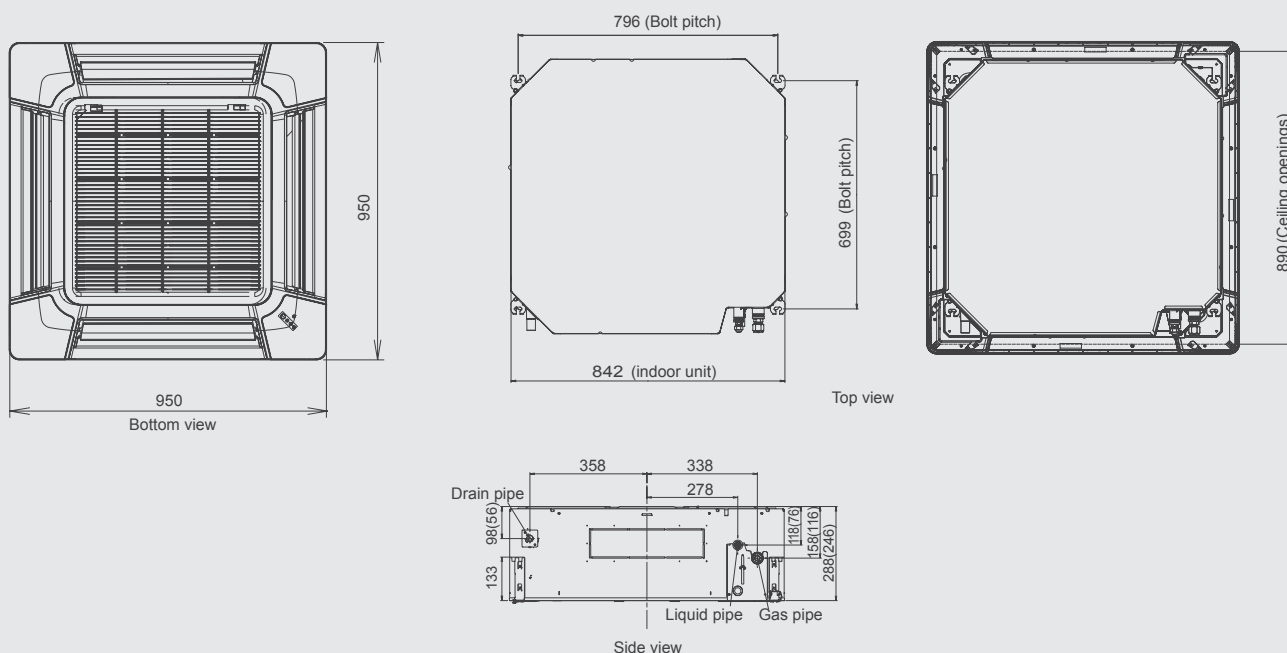



# INVERTER Cassette



## Comfortable airflow

### 4 step swing

Auto air flow direction and auto swing

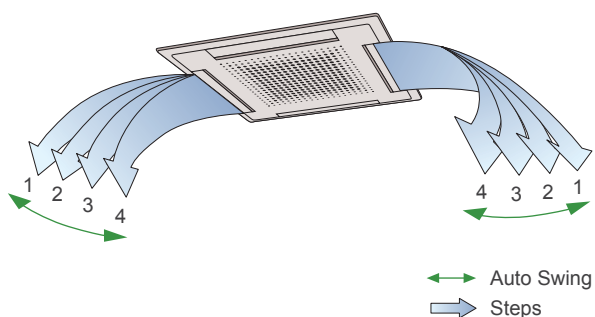

### 2-4 way air flow system

Select 2-way, 3-way or 4-way air flow to suit your needs.

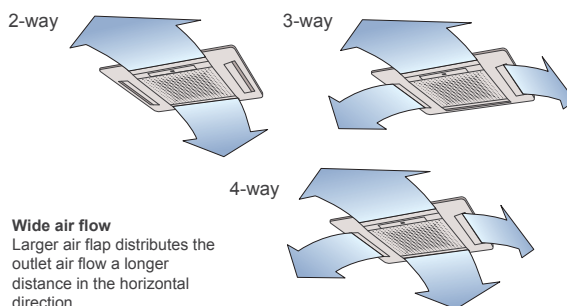

## Specifications

Model No.	Indoor unit		AUYA45LA	AUYS4LU
	Outdoor unit		AOYA45LA	AOYS4LU
Power Source	V/Ø/Hz		230/1/50	230/1/50
Capacity	Cooling	kW	12.50	13.30
	Heating	kW	14.00	16.00
Input Power	Cooling/Heating	kW	3.89/3.77	5.45/4.95
EER - Energy Class	Cooling	W/W	3.21-A	2.44
COP - Energy Class	Heating		3.71-A	3.23
Running Current	Cooling/Heating	A	17.0/16.5	23.8/21.6
Moisture Removal		l/h	4.5	5.5
Noise (Indoor)	Cooling	H/M/L/Q	52/47/42/39	50/48/45/-
Noise (Outdoor)	Cooling		55	54
Airflow Rate (High)	Indoor/Outdoor	m³/h	1750/6600	1700/6600
Net Dimension H x W x D	Indoor	mm	296x830x830	296x830x830
		kg(lbs)	32(70)/7(16)	33(72)/7(16)
	Outdoor	mm	1290x900x330	1290x900x330
		kg(lbs)	98(216)	105(231)
Piping Connections (Small / Large)		mm	9.52/15.88	9.52/15.88
Drain Pipe Diameter (Inner/Outer)		mm	32.0/37.0	32.0/37.0
Max Pipe Length (Chargeless)		m	50	70
Height Difference			30	30
Operation Range	Cooling	°CDB	-15~46	-15~43
	Heating		-15~24	-15~24
Refrigerant			R410A	R410A

## Duct connection hole opening

Conditioned air can be distributed by means of a distribution duct

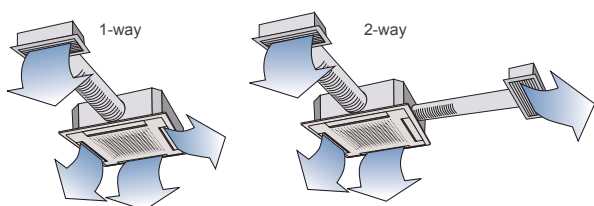

Fresh air can be introduced through this opening

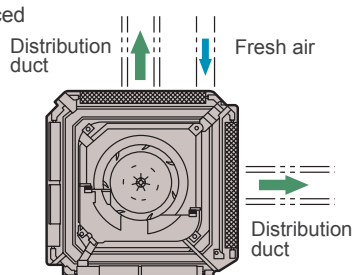

## Flexible installation

Installation is done by "Standard setting" with more than 300mm of space. "Slender setting" lets it suitable for minimum 265mm installation space.

Installation Space (Built-in measurement)

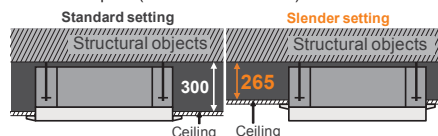

## Easy installation (For 45LA)

Main work settings can be done easily from the remote controller at installation

### Main work settings

- High ceiling setting
- Auto restart
- Temperature adjustment when cooling / heating

### Conventional type

Setting by DIP switch inside control box



### Setting by wireless or wired remote controller

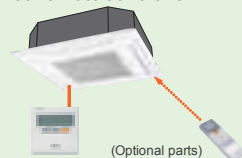

## Condensate pump lift to 800mm

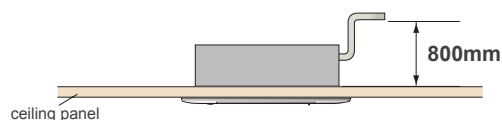

## Optional parts

Wireless Remote Controller: UTB-YNA (for 45LA)  
Additional Grille: UTG-AGEA-W

## Dimensions

Models: AUYA45LA / AUY54LU

(Unit : mm)

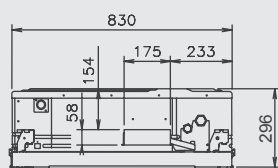

Side view

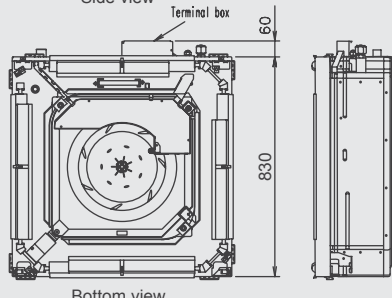

Bottom view

### Selection of setting

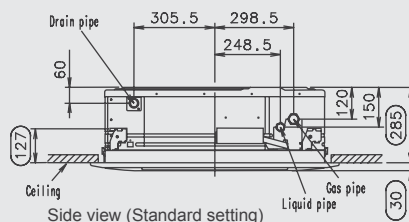

Side view (Standard setting)

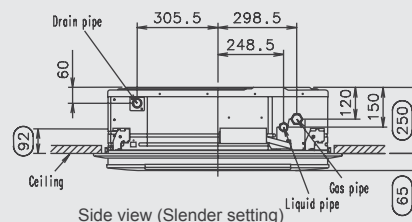

Side view (Slender setting)

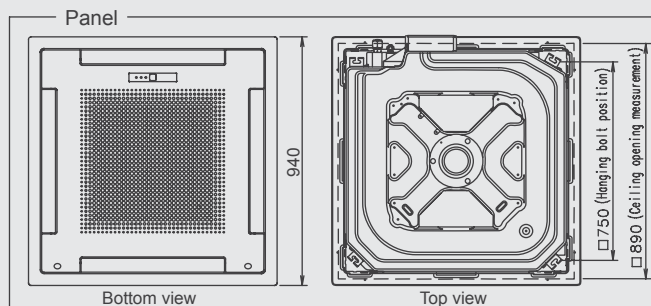

Bottom view

Top view

# Cassette

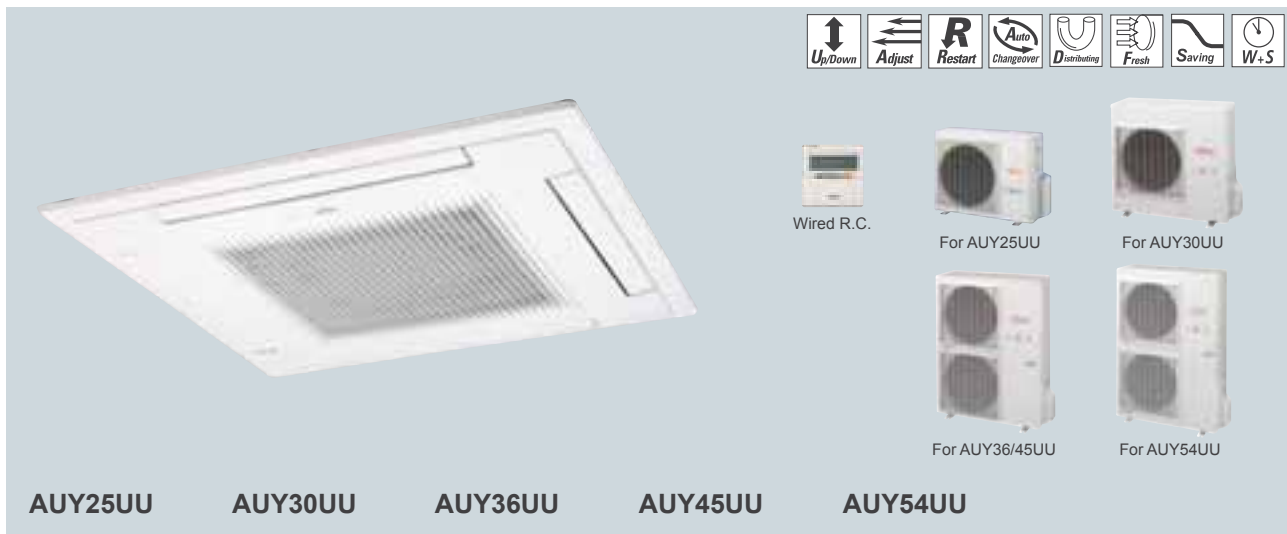

## Comfortable airflow

### 4 step swing

Auto air flow direction and auto swing

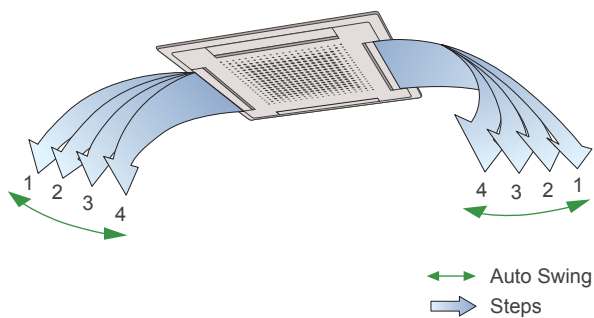

### 2-4 way air flow system

Select 2-way, 3-way or 4-way air flow to suit your needs.

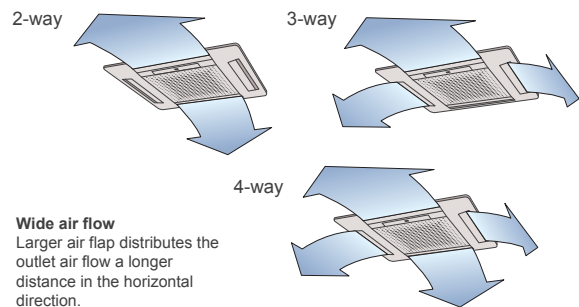

## Specifications

Model No.	Indoor unit		AUY25UU	AUY30UU	AUY36UU	AUY45UU	AUY54UU
	Outdoor unit		AOY25UU	AOY30UU	AOY36UU	AOY45UU	AOY54UU
Power Source	V/Ø/Hz		230/1/50	230/1/50	400/3/50	400/3/50	400/3/50
Capacity	Cooling	kW	7.00	8.40	10.50	12.70	14.50
	Heating		7.80	9.50	11.80	14.30	16.50
Input Power	Cooling/Heating	kW	2.65/2.35	2.95/2.78	3.48/3.65	4.38/4.39	5.16/5.30
EER - Energy Class	Cooling	W/W	2.64-D	2.85-C	3.02-B	2.90	2.81
COP - Energy Class	Heating		3.32-C	3.42-B	3.23-C	3.26	3.11
Running Current	Cooling/Heating	A	11.8/10.5	13.6/13.1	5.9/6.2	7.7/7.7	9.5/9.5
Moisture Removal	l/h		2.5	3.0	4.0	5.0	6.0
Noise (Indoor)	Cooling	H/M/L dB(A)	44/42/39	46/44/39	48/44/41	49/47/43	52/48/45
Noise (Outdoor)	Cooling		53	53	54	54	54
Airflow Rate (High)	Indoor/Outdoor	m³/h	1100/3200	1250/3300	1500/6100	1550/6100	1700/6300
Net Dimension H x W x D	Indoor	mm	246x830x830	246x830x830	296x830x830	296x830x830	296x830x830
		kg(lbs)	34(75)	34(75)	37(82)	40(88)	40(88)
	Outdoor	mm	650x830x320	830x900x330	1165x900x330	1165x900x330	1290x900x330
		kg(lbs)	59(130)	69(152)	94(207)	113(249)	118(260)
Piping Connections (Small / Large)	mm		9.52/15.88	9.52/15.88	9.52/15.88	9.52/19.05	9.52/19.05
Max Pipe Length (Chargeless)	m		25	30	50	50	50
Height Difference	m		15	15	30	30	30
Operation Range	Cooling	°CDB	0~43	0~43	0~43	0~43	0~43
	Heating		-7~24	-7~24	-10~24	-10~24	-10~24
Refrigerant			R410A	R410A	R410A	R410A	R410A

## Flexible installation

Installation is done by "Standard setting" with more than 300mm (250mm) of space. "Slender setting" lets it suitable for minimum 265mm (215mm) installation space.

Installation Space (Built-in measurement)

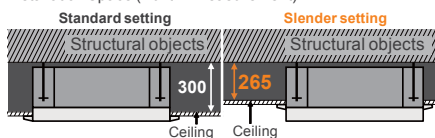

	25UU/30UU	36UU/45UU/54UU
Standard setting	250mm	300mm
Slender setting	215mm	265mm

## Easy maintenance

The control box is easily accessible for maintenance work. Wide opening for easy access.

### Detachable, washable filter and intake grille

Wide opening and long-life filter

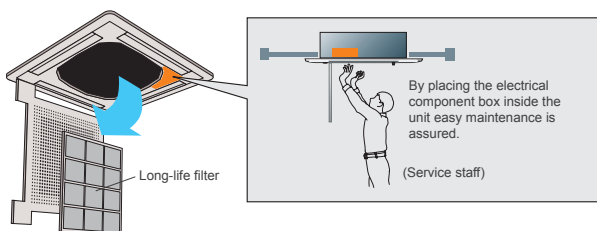

### Long-life filter

High efficiency, long-life filter extends the cleaning cycle.

## Duct connection hole opening

Conditioned air can be distributed by means of a distribution duct

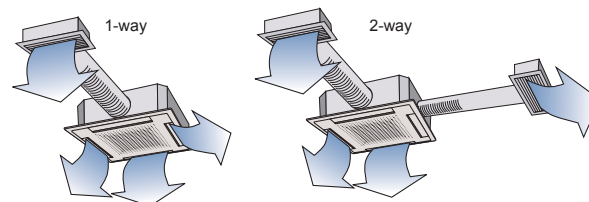

Fresh air can be introduced through this opening

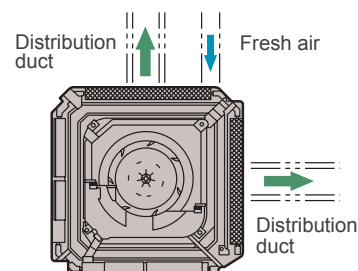

## Condensate pump lift to 800mm

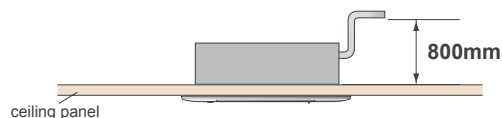

## Dimensions

(Unit : mm)

Models: AUY25UU / AUY30UU

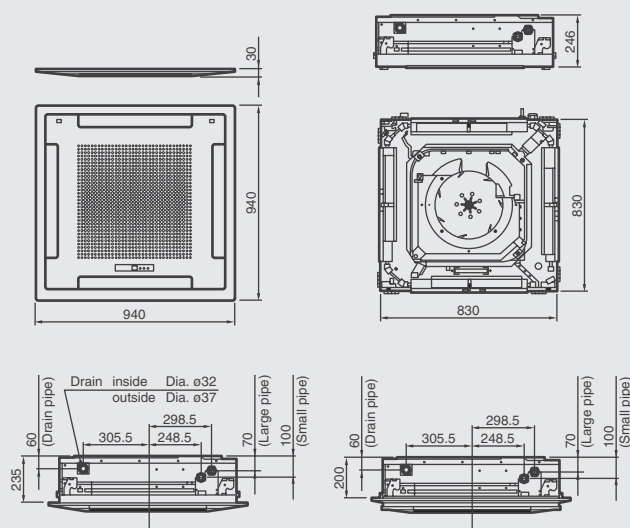

Models: AUY36UU / AUY45UU / AUY54UU

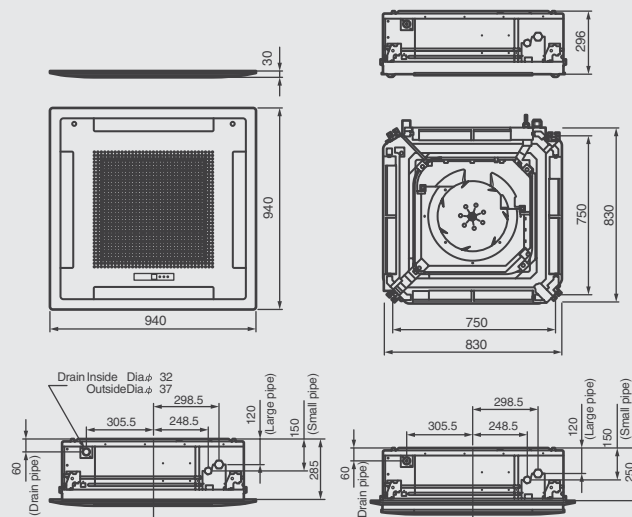

# INVERTER

## Floor/Ceiling Universal



**CLASS A ALL DC**  
**ABYF18LB**

**CLASS A ALL DC**  
**ABYF24LB**



Wireless R.C.

Optional



Wired R.C.

















Optional

Wired R.C.  
Optional

### Flexible installation

#### Example for floor installation

Floor console



#### Example for ceiling installation

Under ceiling



### Specifications

Model No.	Indoor unit		ABYF18LB	ABYF24LB
	Outdoor unit		AOYA18LA	AOYA24LA
Power Source	V/Ø/Hz		230/1/50	230/1/50
Capacity	Cooling	kW	5.20	7.10
	Heating		6.00	8.00
Input Power	Cooling/Heating	kW	1.62/1.66	2.21/2.21
EER - Energy Class	Cooling	W/W	3.21-A	3.21-A
COP - Energy Class	Heating		3.61-A	3.61-A
Running Current	Cooling/Heating	A	7.1/7.3	9.7/9.7
Moisture Removal		l/h	2.0	2.7
Noise (Indoor)	Cooling	H/M/L/Q	43/40/34/31	48/44/40/35
Noise (Outdoor)	Cooling		50	52
Airflow Rate (High)	Indoor/Outdoor	m³/h	780/2000	980/2470
Net Dimension H x W x D	Indoor	mm	199x990x655	199x990x655
		kg(lbs)	27(60)	27(60)
	Outdoor	mm	578x790x300	578x790x315
		kg(lbs)	40(88)	44(97)
Piping Connections (Small / Large)		mm	6.35/12.70	6.35/15.88
Drain Pipe Diameter (Inner/Outer)		mm	21.5/26.0	21.5/26.0
Max Pipe Length (Chargeless)		m	25	30
Height Difference			15	20
Operation Range	Cooling	°CDB	-10~46	-10~46
	Heating		-15~24	-15~24
Refrigerant			R410A	R410A



## Double auto swing

A combination of right/left and up/down directional swing allows 3-dimensional air direction control

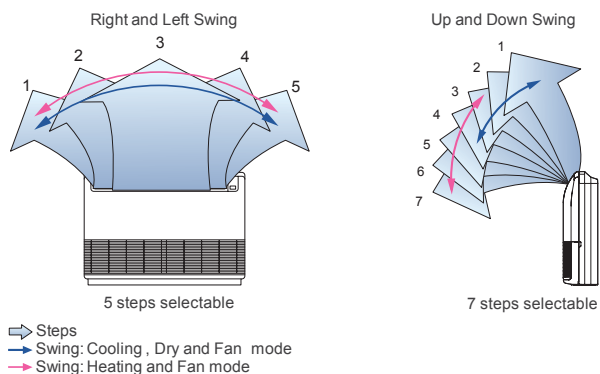

## Low ambient operation

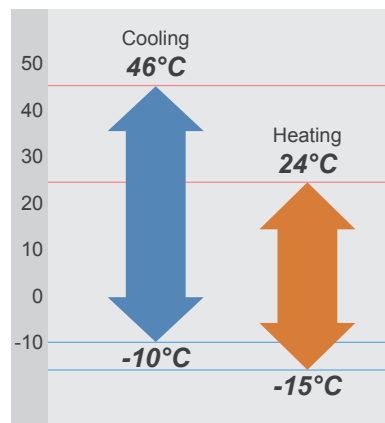

## Easy installation

Main work settings can be done easily from the remote controller at installation

### Main work settings

- High ceiling setting
- Auto restart
- Temperature adjustment when cooling / heating

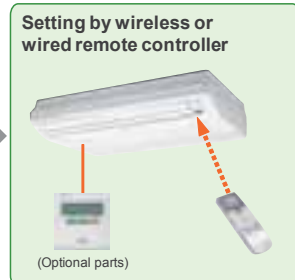
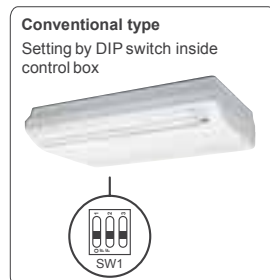

## Optional parts

Wired Remote Controller: UTB-YUD

## Dimensions Models: ABYF18LB / ABYF24LB

(Unit : mm)

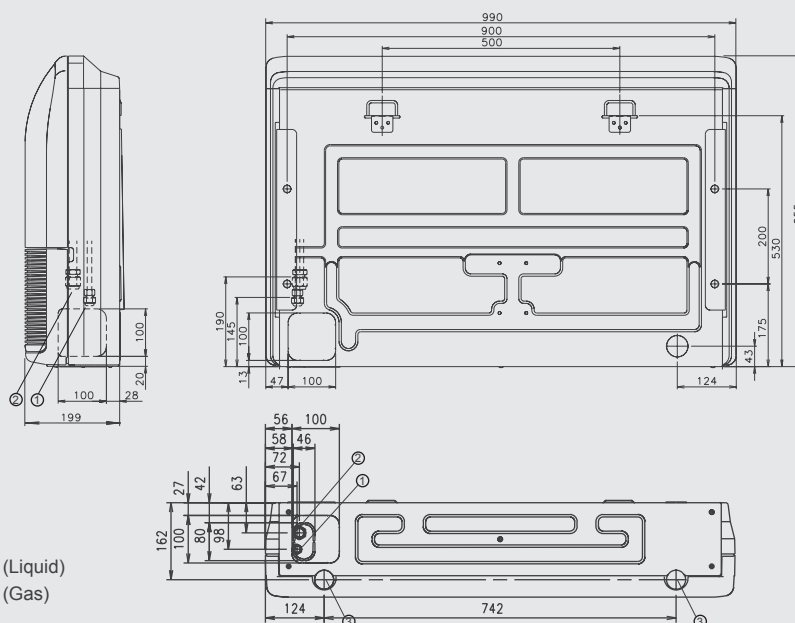

- ① Refrigerant piping flare connection (Liquid)
- ② Refrigerant piping flare connection (Gas)
- ③ Drain piping connection

# Floor/Ceiling Universal



## Flexible installation

### Example for floor installation

Floor console



### Example for ceiling installation

Under ceiling



## Specifications

Model No.	Indoor unit		ABY14UB	ABY18UB	ABY24UB
	Outdoor unit		AOY14UB	AOY18UB	AOY24UB
Power Source	V/Ø/Hz		230/1/50	230/1/50	230/1/50
Capacity	Cooling	kW	4.00	5.40	6.50
	Heating		4.70	6.00	7.40
Input Power	Cooling/Heating		1.42/1.35	1.9/1.85	2.42/2.30
EER - Energy Class	Cooling	W/W	2.82-C	2.84-C	2.69-D
COP - Energy Class	Heating		3.48-B	3.24-C	3.22-C
Running Current	Cooling/Heating		6.3/6.0	8.6/8.3	10.8/10.3
Moisture Removal			1.5	2.0	2.5
Noise (Indoor)	Cooling	H/M/L	40/37/34	46/41/37	49/45/41
Noise (Outdoor)	Cooling				
Airflow Rate (High)	Indoor/Outdoor		640/1600	780/3200	880/3200
Net Dimension H x W x D	Indoor	mm	199x990x655	199x990x655	199x990x655
		kg(lbs)	28(62)	28(62)	28(62)
	Outdoor	mm	530x750x250	650x830x320	650x830x320
		kg(lbs)	35(77)	52(115)	59(130)
Piping Connections (Small / Large)			6.35/12.70	6.35/15.88	9.52/15.88
Max Pipe Length (Chargeless)			15	20	20
Height Difference			8	8	8
Operation Range	Cooling	°CDB	0~43	0~43	0~43
	Heating		-6~24	-6~24	-6~24
Refrigerant			R410A	R410A	R410A

## Double auto swing

A combination of up/down and right/left directional swing allows three-dimensional air direction control.

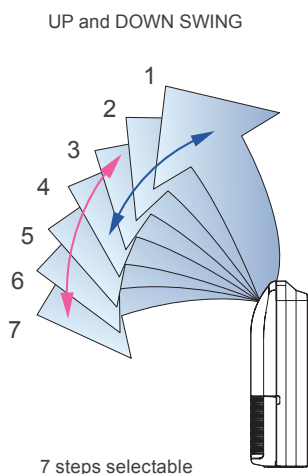
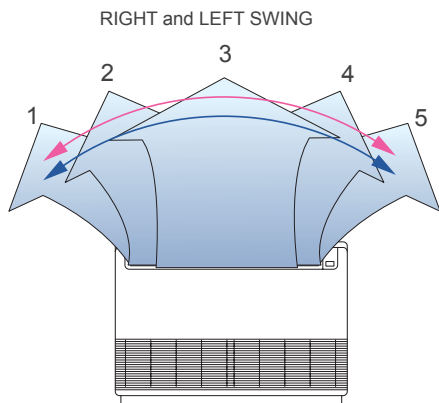

## Super vane

Double Louvre Super vane with newly developed special configuration boosts airflow sending cool air quickly to every corner of the room.

## Auto-closing louvre

When operation is stopped, the louvres will automatically close. (This function is available on all non-ducted models.)

## Compact design

Symmetrical, slim and compact design.

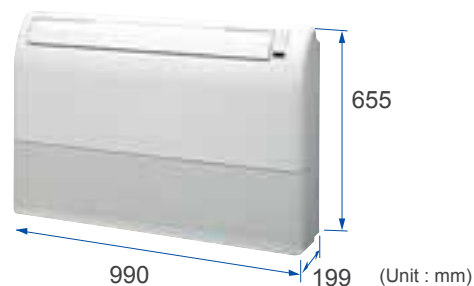

## Dimensions Models: ABY14UB / ABY18UB / ABY24UB

(Unit : mm)

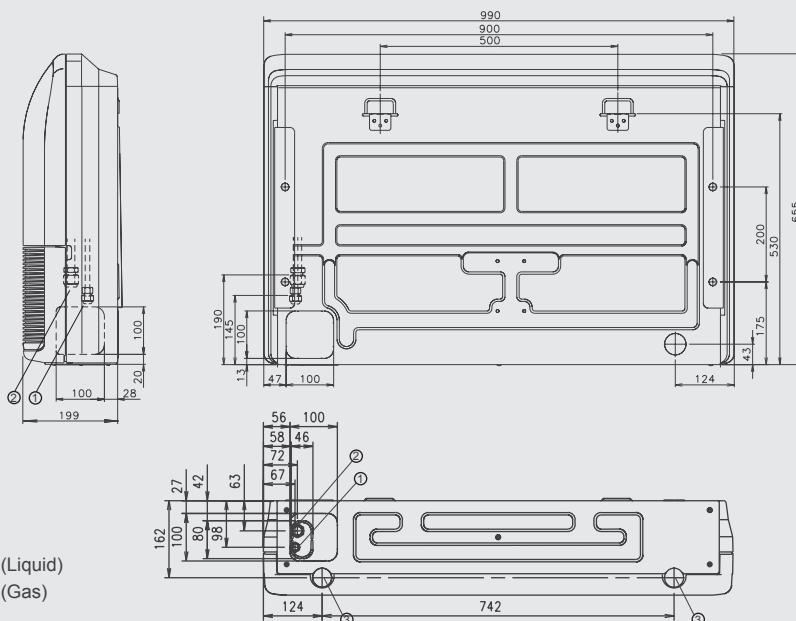

# INVERTER Ceiling

Easily concealed in any installation

















Optional: Wireless R.C., Wired R.C., For ABYA30/36LB, For ABYA45LB (For single phase), For ABYA36/45/54LC (For 3 phase)

**CLASS A ALL DC** ABYA30LB  
**CLASS A ALL DC** ABYA36LB  
**CLASS A ALL DC** ABYA36LC **NEW**  
**CLASS A ALL DC** ABYA45LC **NEW**  
**CLASS A ALL DC** ABYA54LC **NEW**

## Installation

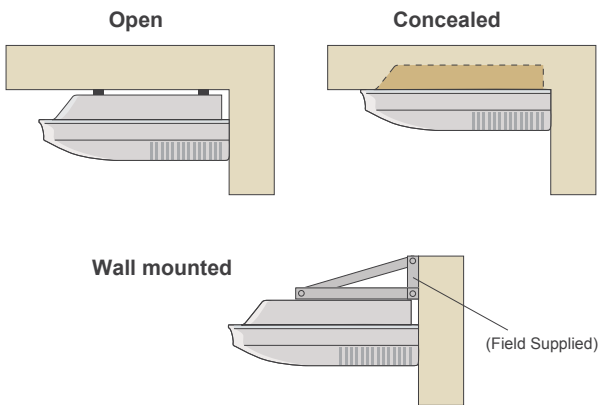

## Multi auto swing

A combination of right/left and up/down directional swing allows 3-dimensional air direction control.

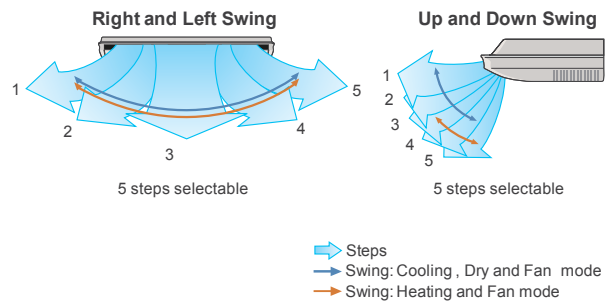

## Specifications

Model No.	Indoor unit		ABYA30LB	ABYA36LB	ABYA36LC	ABYA45LC	ABYA45LC	ABYA54LC
	Outdoor unit		AOYA30LB	AOYA36LB	AOYD36LA	AOYA45LB	AOYD45LA	AOYD54LA
Power Source	V/∅/Hz		230/1/50	230/1/50	400/3/50	230/1/50	400/3/50	400/3/50
Capacity	Cooling	kW	8.50	9.40	10.00	12.50	12.50	14.00
	Heating	kW	10.00	11.20	11.20	14.00	14.00	16.00
Input Power	Cooling/Heating	kW	2.65/2.77	2.93/3.02	2.84/2.87	3.89/3.77	3.89/3.88	4.65/4.67
EER - Energy Class	Cooling	W/W	3.21-A	3.21-A	3.52-A	3.21-A	3.21-A	3.01-B
COP - Energy Class	Heating	W/W	3.61-A	3.71-A	3.9-A	3.71-A	3.61-A	3.43-B
Running Current	Cooling/Heating	A	11.6/12.1	12.8/13.2	4.3/4.4	17.0/16.5	5.8/5.8	6.9/6.9
Moisture Removal		l/h	2.5	3.0	3.0	4.5	4.5	5.0
Noise (Indoor)	Cooling   H/M/L/Q	dB(A)	45/43/37/32	47/43/37/32	47/43/37/32	49/45/39/34	49/45/39/34	51/48/42/38
Noise (Outdoor)	Cooling		53	54	51	55	54	55
Airflow Rate (High)	Indoor / Outdoor	m³/h	1600/3600	1900/3600	1900/6200	2100/6600	2100/6900	2300/6900
Net Dimension H x W x D	Indoor	mm	240×1660×700	240×1660×700	240×1660×700	240×1660×700	240×1660×700	240×1660×700
		kg(lbs)	46(101)	46(101)	46(101)	46(101)	46(101)	48(106)
	Outdoor	mm	830×900×330	830×900×330	1290×900×330	1290×900×330	1290×900×330	1290×900×330
		kg(lbs)	62(136)	62(136)	107(236)	98(216)	107(236)	107(236)
Piping Connections (Small / Large)	mm	9.52/15.88	9.52/15.88	9.52/15.88	9.52/15.88	9.52/15.88	9.52/15.88	
Drain Pipe Diameter (Inner/Outer)	mm	22.0/25.6	22.0/25.6	22.0/25.6	22.0/25.6	22.0/25.6	22.0/25.6	
Max Pipe Length (Chargeless)	m	50	50	75	50	75	75	
Height Difference	m	30	30	30	30	30	30	
Operation Range	Cooling	°CDB	-15~46	-15~46	-15~46	-15~46	-15~46	-15~46
	Heating	°CDB	-15~24	-15~24	-15~24	-15~24	-15~24	-15~24
Refrigerant			R410A	R410A	R410A	R410A	R410A	R410A

### Condensate lift-up mechanism (Option)

Optional drain lift-up mechanism allows flexible installation.

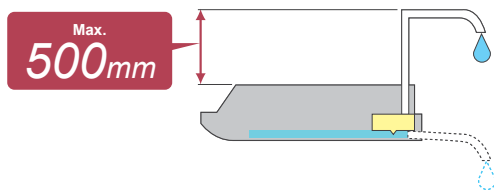

### Low ambient operation

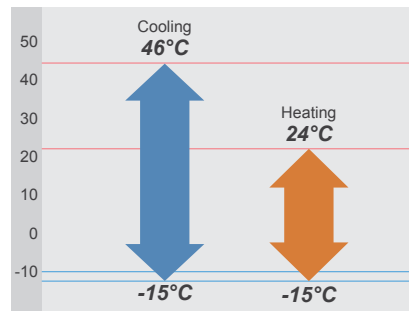

### Easy installation

Main work settings can be done easily from the remote controller at installation

- Main work settings**
- High ceiling setting
  - Auto restart
  - Temperature adjustment when cooling / heating

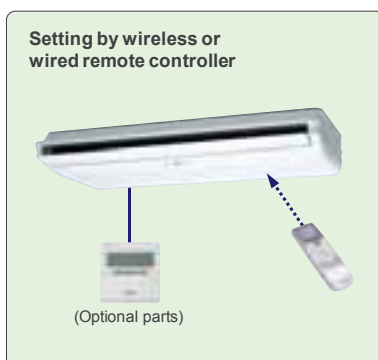
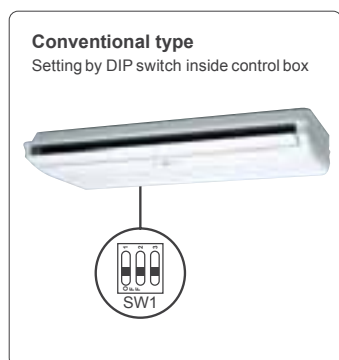

### Fresh air intake

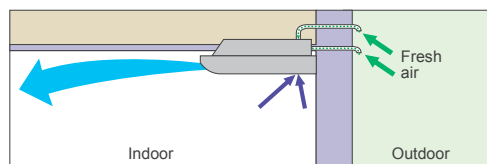

### Optional parts

- Wired Remote Controller: UTB-YUD
- Drain Pump Unit: UTR-DPB24T

### Dimensions

Models: ABYA30LB / ABYA36LB / ABYA36LC / ABYA45LC / ABYA54LC

(Unit : mm)

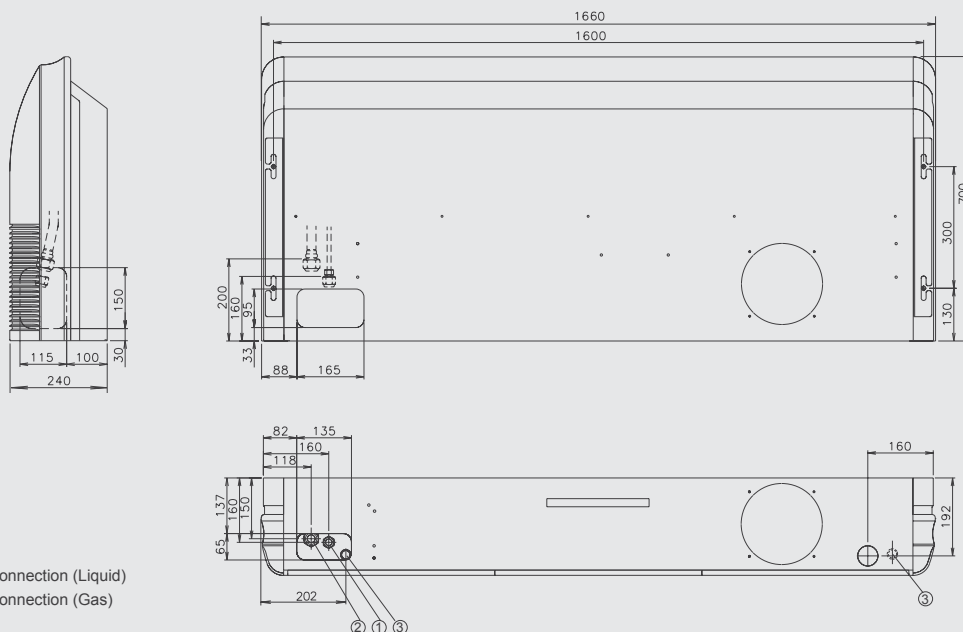

# Ceiling



## Installation

Open

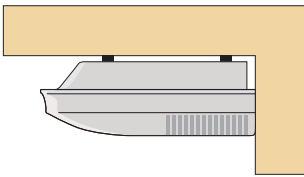

General installation pattern which suspends the indoor unit from the ceiling.

Concealed

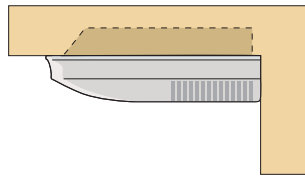

Installation pattern where part of the indoor unit is embedded into the ceiling.

Wall mounted

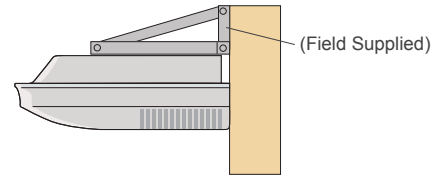

Installation which fixes the indoor unit to the wall by the use of wall brackets (Field supplied). This type of installation can be used when the ceiling space is insufficient.

## Specifications

Model No.	Indoor unit		ABY30UB	ABY36UB	ABY45UB	ABY54UB	
	Outdoor unit		AOY30UB	AOY36UB	AOY45UB	AOY54UB	
Power Source	V/Ø/Hz		230/1/50	400/3/50	400/3/50	400/3/50	
Capacity	Cooling	kW	8.40	10.50	12.70	14.50	
	Heating		9.50	11.80	14.30	16.50	
Input Power	Cooling/Heating		2.95/2.78	3.48/3.45	4.38/4.39	5.16/5.30	
EER - Energy Class	Cooling	W/W	2.85-C	3.02-B	2.90	2.81	
COP - Energy Class	Heating		3.42-B	3.42-B	3.26	3.11	
Running Current	Cooling/Heating		13.6/13.1	5.9/6.2	7.7/7.7	9.5/9.5	
Moisture Removal	l/h		3.0	4.0	5.0	6.0	
Noise (Indoor)	Cooling	H/M/L	dB(A)	42/39/35	45/42/37	48/46/41	
Noise (Outdoor)	Heating						
Airflow Rate (High)	Indoor/Outdoor		m <sup>3</sup> /h	1450/3300	1660/6100	1850/6100	2200/6300
Net Dimension H x W x D	Indoor	mm	240x1660x700	240x1660x700	240x1660x700	240x1660x700	
		kg(lbs)	48(106)	48(106)	48(106)	48(106)	
	Outdoor	mm	830x900x330	1165x900x330	1165x900x330	1290x900x330	
		kg(lbs)	69(152)	94(207)	113(249)	118(260)	
Piping Connections (Small / Large)	mm		9.52/15.88	9.52/15.88	9.52/19.05	9.52/19.05	
Max Pipe Length (Chargeless)	m		30	50	50	50	
Height Difference	m		15	30	30	30	
Operation Range	Cooling	°CDB	0~43	0~43	0~43	0~43	
	Heating		-7~24	-10~24	-10~24	-10~24	
Refrigerant			R410A	R410A	R410A	R410A	



## Double auto swing and wide airflow

Auto airflow direction and auto swing

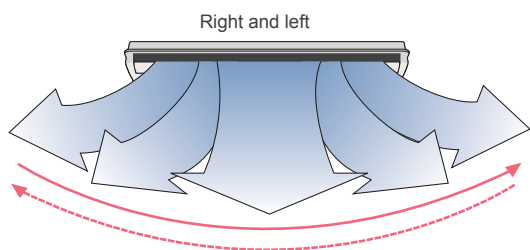

5 steps selectable

Up and Down Swing

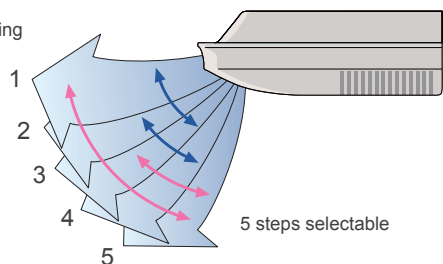

5 steps selectable

## Long Airflow

Long Airflow ensures comfort to every corner of a large room.

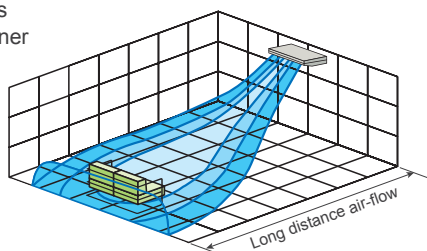

## Slim & Compact design



## Condensate lift-up mechanism (Option)

Optional drain lift-up mechanism allows flexible installation.

Max. 500mm

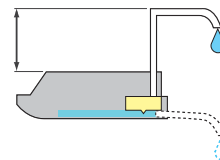

## Fresh air intake

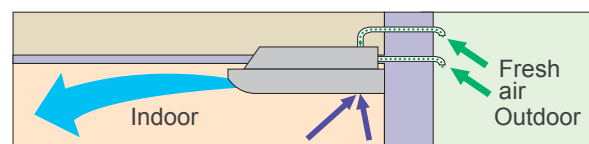

## Long-life filter

High efficiency long-life filter doubles the life of the filter compared to standard filters.

## Optional parts

Drain Pump Unit: UTR-DPB24T

## Dimensions

Models: ABY30UB / ABY36UB / ABY45UB / ABY54UB

(Unit : mm)

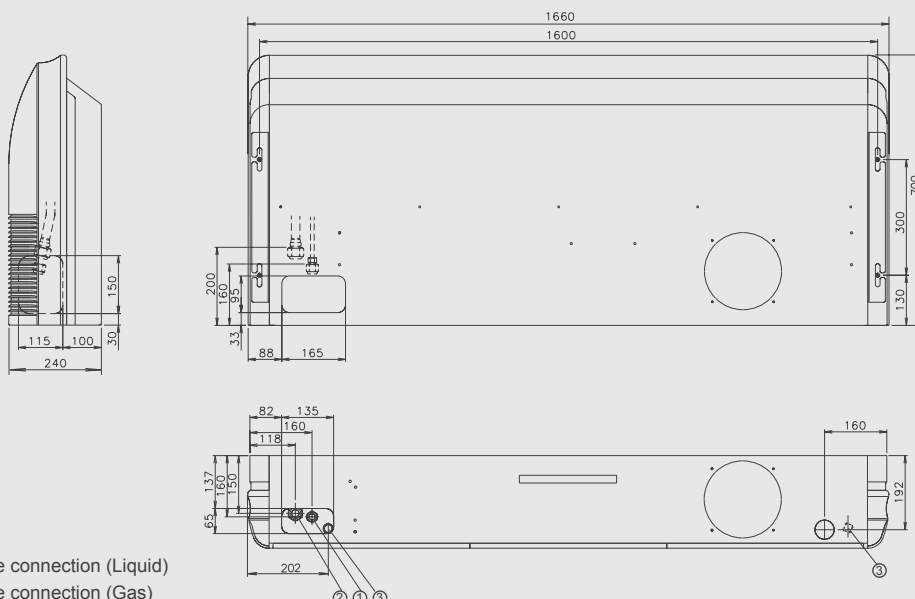

- ① Refrigerant piping flare connection (Liquid)
- ② Refrigerant piping flare connection (Gas)
- ③ Drain piping connection

# INVERTER Compact Duct



## Static pressure mode setting

Static pressure mode can be selected from 4 modes, to meet wide-ranging installation conditions.

### Static pressure range (High speed mode)

**ARYF12LA/14LA/18LB 0 to 90 Pa**

In case of ARYF12LA

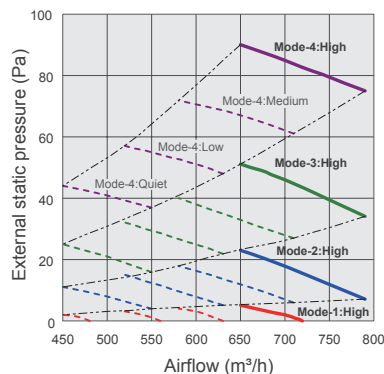

In case of ARYF14LA/18LB

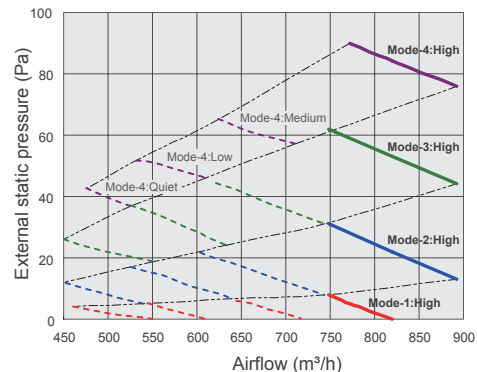

## Specifications

Model No.	Indoor unit		ARYF12LA	ARYF14LA	ARYF18LB
	Outdoor unit		AOYA12LA	AOYA14LA	AOYA18LA
Power Source	V/Ø/Hz		230/1/50	230/1/50	230/1/50
Capacity	Cooling	kW	3.50	4.30	5.20
	Heating		4.10	5.00	6.00
Input Power	Cooling/Heating	kW	1.05/1.11	1.33/1.34	1.62/1.66
EER - Energy Class	Cooling	W/W	3.33-A	3.21-A	3.21-A
COP - Energy Class	Heating		3.69-A	3.71-A	3.61-A
Running Current	Cooling/Heating	A	4.6/4.9	5.8/5.9	7.1/7.3
Moisture Removal			l/h	1.3	1.5
Noise (Indoor)	Cooling	H/M/L/Q	dB(A)	32/30/28/26	33/31/29/27
Noise (Outdoor)	Cooling			47	49
Airflow Rate (High)	Indoor/Outdoor	m³/h	720/1780	870/1910	820/2000
Net Dimension H x W x D	Indoor	mm	217x953x595	217x953x595	217x953x595
		kg(lbs)	23(51)	23(51)	23(51)
	Outdoor	mm	578x790x300	578x790x300	578x790x300
		kg(lbs)	40(88)	40(88)	40(88)
Piping Connections (Small / Large)			mm	6.35/9.52	6.35/12.70
Drain Pipe Diameter (Inner/Outer)			mm	21.5/26.0	21.5/26.0
Max Pipe Length (Chargeless)			m	25	25
Height Difference			m	15	15
Operation Range	Cooling	°CDB	-10~46	-10~46	-10~46
	Heating		-15~24	-15~24	-15~24
Refrigerant			R410A	R410A	R410A

## Compact design

Ultra-slim duct air conditioner for easy installation

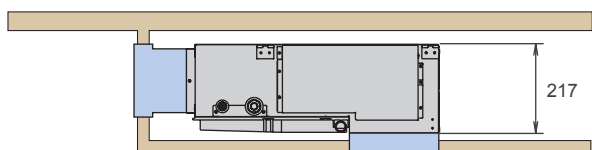

Slim size (217mm) allows installation even where the space behind the ceiling is narrow.

## Two-direction drain piping

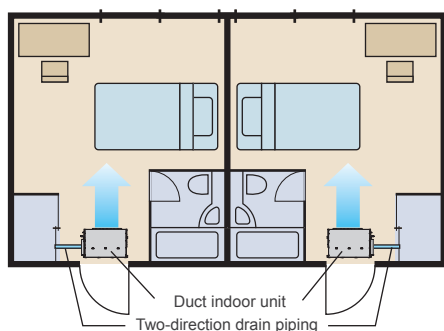

## Flexible installation

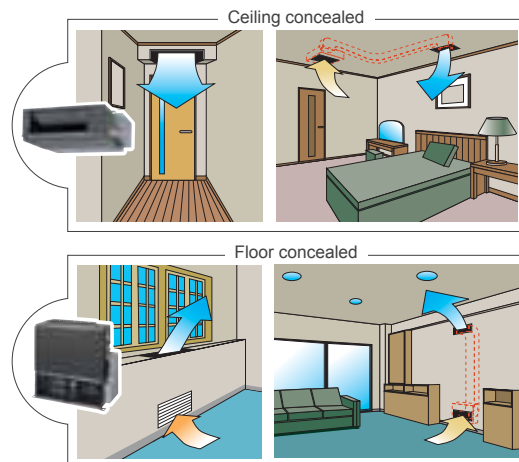

## Filter (Accessory)

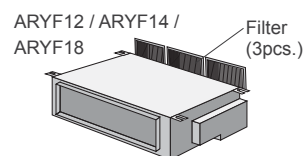

## Air-intake

Air intake direction can be selected to match the installation site.

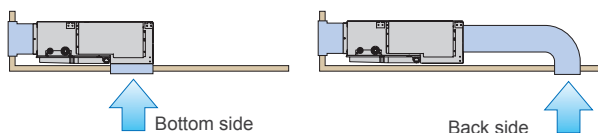

## Optional parts

- Remote Sensor Unit: UTD-RS100
- IR Receiver Unit: UTY-LRHY1
- Drain Pump Unit: UTZ-PX1BBA
- External Control Set: UTD-ECS5A

## Dimensions Models: ARYF12LA / ARYF14LA / ARYF18LB

(Unit : mm)

\*Service accessibility must be allowed for when installing the product. Please consult the installation manual for the necessary service access size.

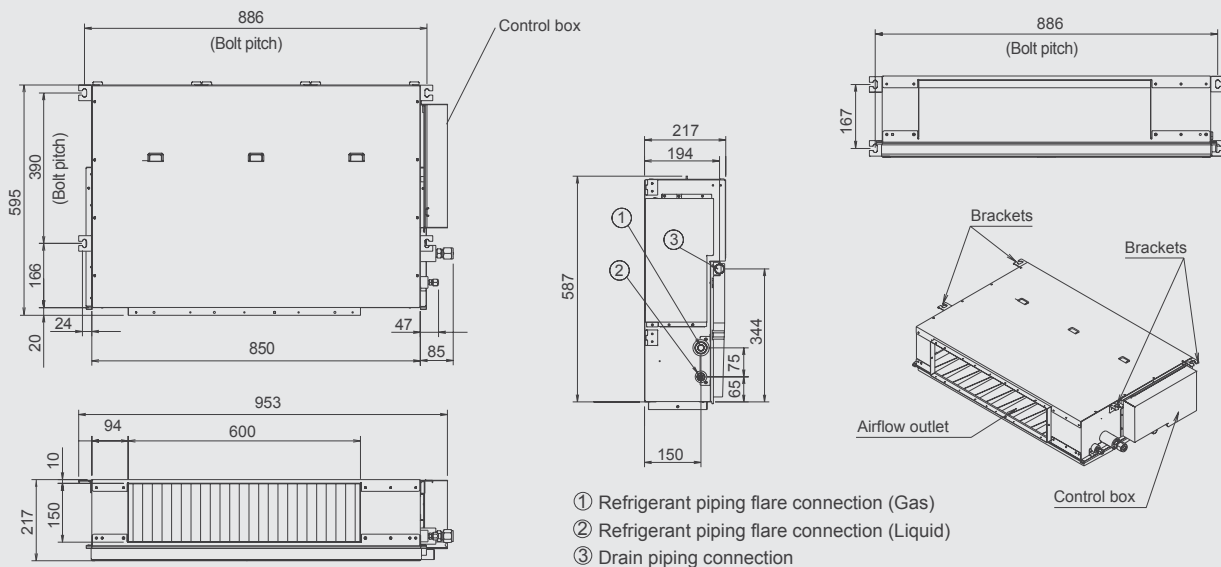

# Compact Duct

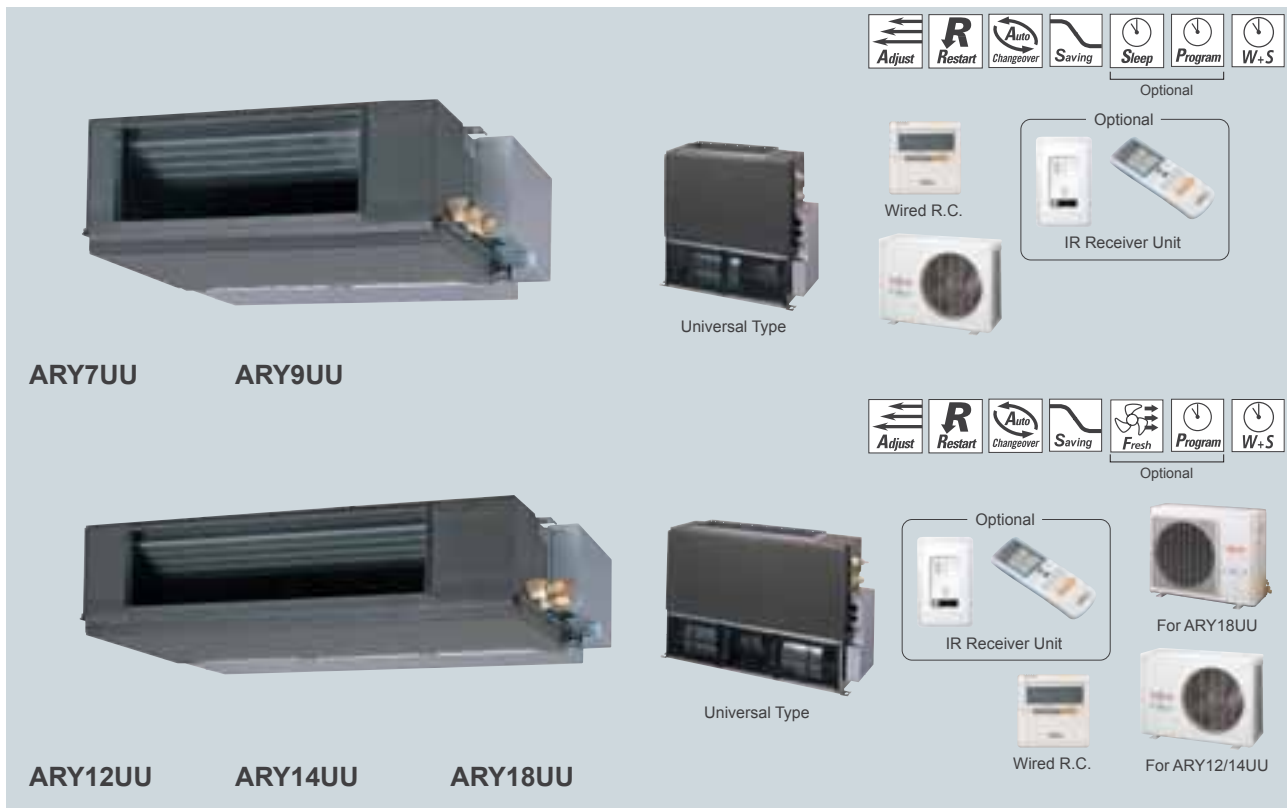

## Optional function for comfort

### Optional parts

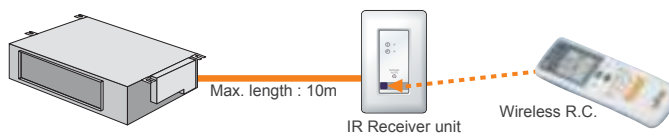

## Specifications

Model No.	Indoor unit		ARY7UU	ARY9UU	ARY12UU	ARY14UU	ARY18UU	
	Outdoor unit		AOY7UU	AOY9UU	AOY12UU	AOY14UU	AOY18UU	
Power Source	V/Ø/Hz		230/1/50	230/1/50	230/1/50	230/1/50	230/1/50	
Capacity	Cooling	kW	2.15	2.70	3.50	4.00	5.40	
	Heating		2.45	3.10	4.00	4.70	6.00	
Input Power	Cooling/Heating		kW	0.76/0.76	0.96/0.96	1.24/1.21	1.42/1.35	1.92/1.87
EER - Energy Class	Cooling		W/W	2.83-C	2.81-C	2.82-C	2.82-C	2.81-C
COP - Energy Class	Heating			3.22-C	3.23-C	3.31-C	3.48-B	3.21-C
Running Current	Cooling/Heating		A	3.6/3.6	4.4/4.5	5.5/5.4	6.3/6.0	8.8/8.7
Moisture Removal			l/h	0.8	1.0	1.2	1.5	1.6
Noise (Indoor)	Cooling	H/M/L	dB(A)	31/28/26	35/33/31	29/28/27	34/32/30	43/40/36
Noise (Outdoor)	Cooling			48	48	49	49	52
Airflow Rate (High)	Indoor/Outdoor		m³/h	340/1600	420/1600	500/1600	640/1600	1000/3200
Net Dimension H x W x D	Indoor	mm	217x663x595	217x663x595	217x953x595	217x953x595	217x953x595	
		kg(lbs)	18(40)	18(40)	25(55)	25(55)	25(55)	
	Outdoor	mm	530x750x250	530x750x250	530x750x250	530x750x250	650x830x320	
		kg(lbs)	28(62)	30(66)	34(75)	35(77)	52(115)	
Piping Connections (Small / Large)			mm	6.35/9.52	6.35/9.52	6.35/9.52	6.35/12.70	6.35/15.88
Max Pipe Length (Chargeless)			m	15	15	15	15	20
Height Difference			m	8	8	8	8	8
Operation Range	Cooling	°CDB	0~43	0~43	0~43	0~43	0~43	
	Heating		-6~24	-6~24	-6~24	-6~24	-6~24	
Refrigerant			R410A	R410A	R410A	R410A	R410A	

## Compact design

Ultra-slim duct air conditioner for easy installation

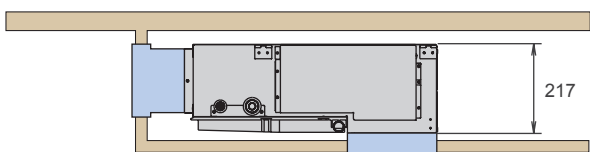

Slim size (217mm) allows installation even where the space behind the ceiling is narrow.

## Two-direction drain piping

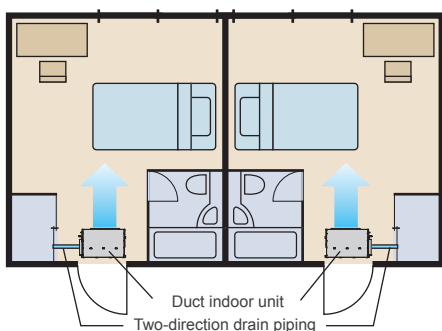

## Air-intake

Air intake direction can be selected to match the installation site.

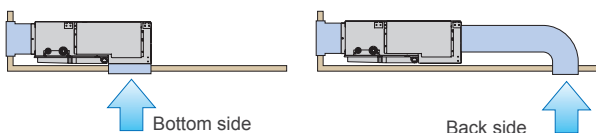

## Flexible installation

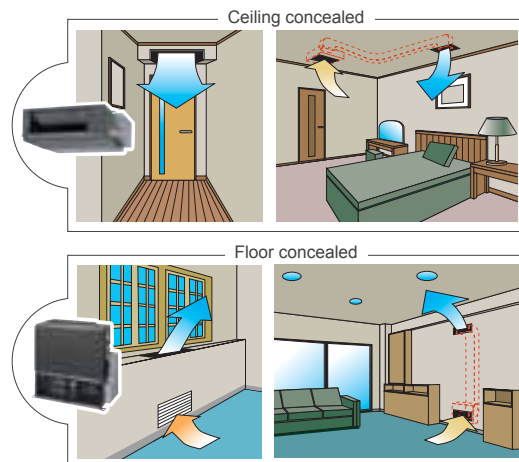

## Filter (Accessory)

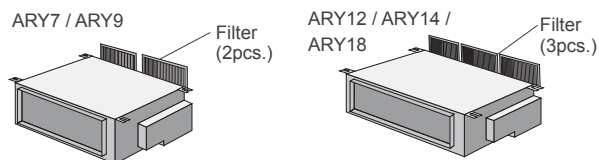

## Optional parts

Remote Sensor Unit: UTD-RS100  
IR Receiver Unit: UTY-LRHY1  
Drain Pump Unit: UTZ-PX1NBA

## Dimensions

Models: ARY7UU / ARY9UU / ARY12UU / ARY14UU / ARY18UU

(Unit : mm)

\*Service accessibility must be allowed for when installing the product.  
Please consult the installation manual for the necessary service access size.

( ) : ARY7UU / ARY9UU

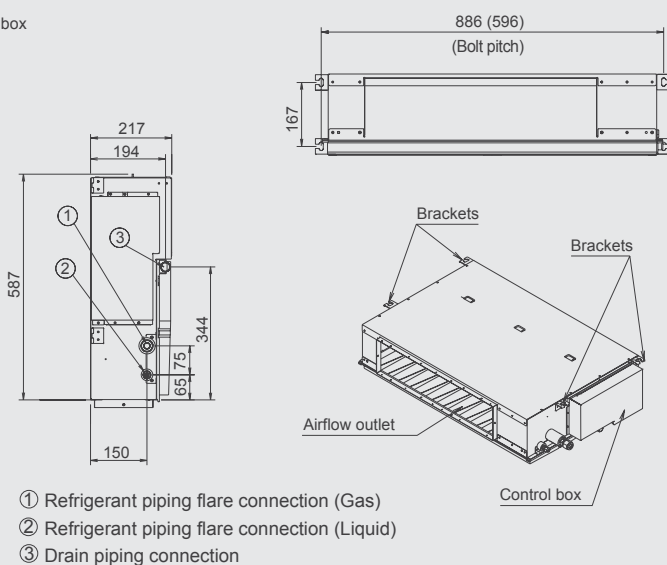
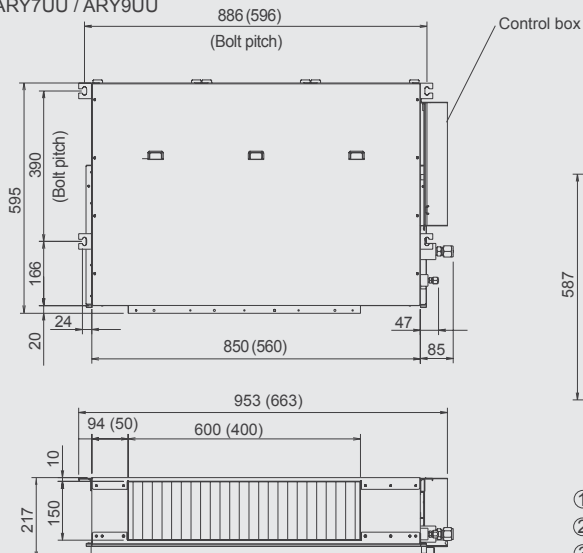

# INVERTER Duct

**CLASS A ALL DC**  
**ARYF24LB**

**CLASS A ALL DC**  
**ARYA30LB**

**CLASS A ALL DC**  
**ARYA36LB**  
**ARYA36LC NEW**

**CLASS A ALL DC**  
**ARYA45LC NEW**

**CLASS A ALL DC**  
**ARYA36/45LC (For 3 phase)**

## Slim & Compact design

In the case of bottom return air connection, not only does the indoor unit design allow for installation in a narrow ceiling space of up to 270mm, Further space savings have been achieved by mounting the electrical control box internally inside the chassis.

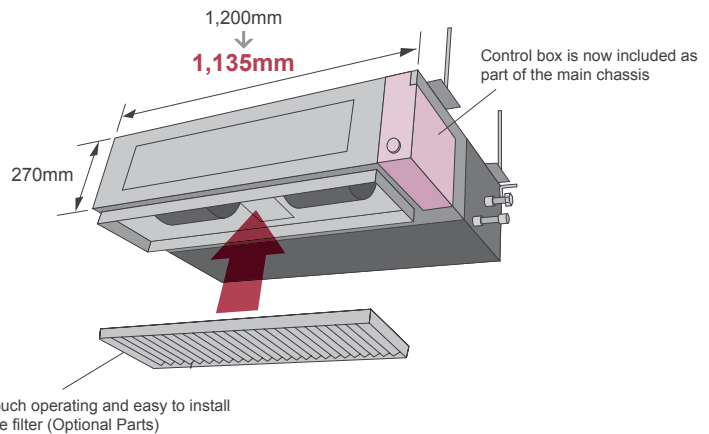

## Specifications

Model No.	Indoor unit		ARYF24LB	ARYA30LB	ARYA36LB	ARYA36LC	ARYA45LC	ARYA45LC
	Outdoor unit		AOYA24LA	AOYA30LB	AOYA36LB	AOYD36LA	AOYA45LB	AOYD45LA
Power Source	V/∅/Hz		230/1/50	230/1/50	230/1/50	400/3/50	230/1/50	400/3/50
Capacity	Cooling	kW	7.10	8.50	9.40	10.00	12.50	12.50
	Heating		8.00	10.00	11.20	11.20	14.00	14.00
Input Power	Cooling/Heating	kW	2.21/2.21	2.65/2.68	2.93/3.1	2.84/2.87	3.89/3.77	3.89/3.88
EER - Energy Class	Cooling	W/W	3.21-A	3.21-A	3.21-A	3.52-A	3.21-A	3.21-A
COP - Energy Class	Heating		3.61-A	3.73-A	3.61-A	3.90-A	3.71-A	3.61-A
Running Current	Cooling/Heating	A	9.7/9.7	11.6/11.7	12.8/13.6	4.3/4.4	17/16.5	5.8/5.8
Moisture Removal	l/h		2.5	2.5	3.0	3.0	3.5	4.5
Noise (Indoor)	Cooling   H/M/L/Q	dB(A)	31/29/27/25	42/37/32/29	42/37/32/29	40/36/31/26	44/38/33/29	42/38/32/28
Noise (Outdoor)	Cooling		52	53	54	51	55	54
Airflow Rate (High)	Indoor / Outdoor	m³/h	1100/2470	2100/3600	2100/4000	1850/6200	2250/6600	2100/6900
Net Dimension H x W x D	Indoor	mm	270x1135x700	270x1135x700	270x1135x700	270x1135x700	270x1135x700	270x1,135x700
		kg(lbs)	38(84)	40(88)	40(88)	40(88)	41(90)	40(88)
	Outdoor	mm	578x790x315	830x900x330	830x900x330	1290x900x330	1290x900x330	1290x900x330
		kg(lbs)	44(97)	62(136)	62(136)	107(236)	98(216)	107(236)
Piping Connections (Small / Large)	mm		6.35/15.88	9.52/15.88	9.52/15.88	9.52/15.88	9.52/15.88	9.52/15.88
Drain Pipe Diameter (Inner/Outer)	mm		36.0/38.0	36.0/38.0	36.0/38.0	36.0/38.0	36.0/38.0	36.0/38.0
Max Pipe Length (Chargeless)	m		30	50	50	75	50	75
Height Difference	m		20	30	30	30	30	30
Operation Range	Cooling	°CDB	-10~46	-15~46	-15~46	-15~46	-15~46	-15~46
	Heating		-15~24	-15~24	-15~24	-15~24	-15~24	-15~24
Refrigerant			R410A	R410A	R410A	R410A	R410A	R410A



## Easy maintenance

Structural improvement is attained by making the bottom panel two pieces, front and rear. The internal fan casing is also manufactured in two pieces, namely upper and lower. The maintenance of the motor and fan can be easily carried out by removing the rear panel and the lower part of the casing while leaving the main chassis installed.

See below for the case of rear suction type

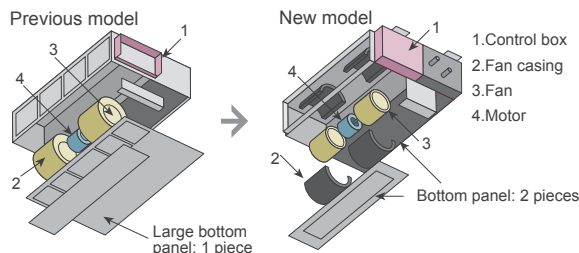

## Easy installation

Main work settings can be done easily from the remote controller at installation

### Main work settings

- High ceiling setting
- Auto restart
- Temperature adjustment when cooling / heating

### Conventional type

Setting by DIP switch inside control box



### Setting by wired remote controller



## Two-direction drain piping

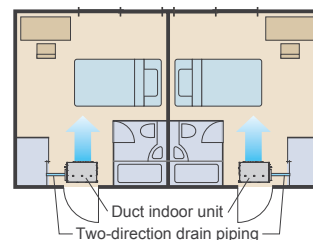

## Installation styles

Embedded in Ceiling

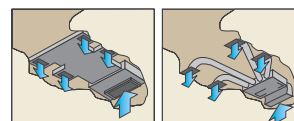

Hanging from Ceiling

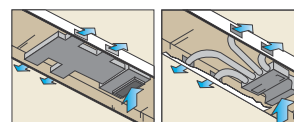

## Optional parts

- Flange (Round) : UTD-RF204
- Flange (Square) : UTD-SF045T
- Long Life Filter : UTD-LF25NA
- Remote Sensor Unit: UTD-RS100
- External Control Set: UTD-ECS5A
- Drain Pump Unit : UTZ-PX1NBA
- IR Receiver Unit : UTY-LRHY1

## Dimensions

Models: ARYF24LB / ARYA30LB / ARYA36LB / ARYA36LC / ARYA45LC

(Unit : mm)

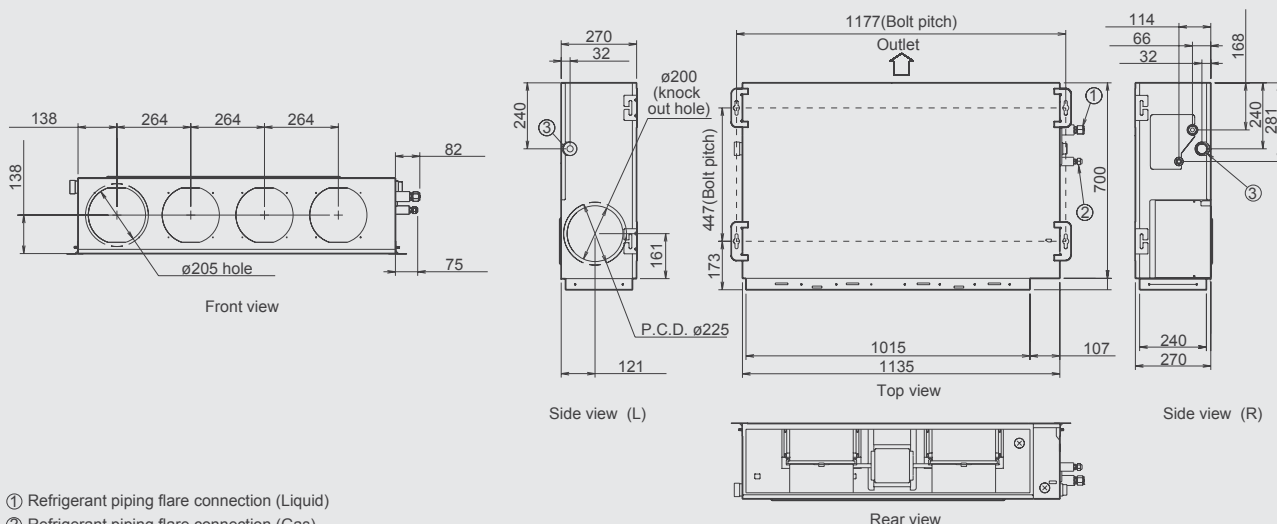

- ① Refrigerant piping flare connection (Liquid)
- ② Refrigerant piping flare connection (Gas)
- ③ Drain piping connection

# Duct



## Slim & Compact design

In the case of bottom return air connection, not only does the indoor unit design allow for installation in a narrow ceiling space of up to 270mm, Further space savings have been achieved by mounting the electrical control box internally inside the chassis.

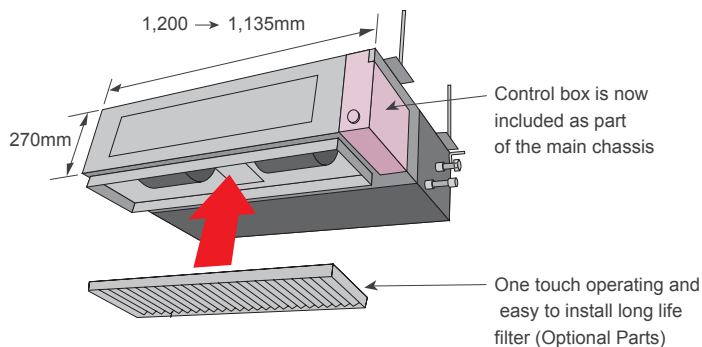

## Specifications

Model No.	Indoor unit		ARY25UU	ARY30UU	ARY36U(1)	ARY36UU	ARY45UU		
	Outdoor unit		AOY25UU	AOY30UU	AOY36UU(1)	AOY36UU	AOY45UU		
Power Source	V/Ø/Hz		230/1/50	230/1/50	230/1/50	400/3/50	400/3/50		
Capacity	Cooling	kW	7.00	8.40	10.50	10.50	12.70		
	Heating		7.70	9.50	12.70	12.70	14.30		
Input Power	Cooling/Heating		kW		2.65/2.33	2.99/2.63	3.60/3.65	3.60/3.65	4.38/4.39
EER - Energy Class	Cooling	W/W	2.64-D	2.81-C	2.92-C	2.92-C	2.90		
COP - Energy Class	Heating		3.30-C	3.61-A	3.48-B	3.48-B	3.26		
Running Current	Cooling/Heating		A		11.8/10.5	14.0/12.4	16.0/16.5	6.1/6.2	7.7/7.7
Moisture Removal			l/h		2.5	3.0	3.5	3.5	5.0
Noise (Indoor)	Cooling	H/M/L	dB(A)		38/36/34	40/38/36	43/41/39	43/41/39	44/42/40
Noise (Outdoor)	Cooling		53	53	54	54	54		
Airflow Rate (High)	Indoor/Outdoor		m³/h		1100/3200	1400/3300	1750/6100	1750/6100	1800/6100
Net Dimension H x W x D	Indoor	mm	270x1135x700	270x1135x700	270x1135x700	270x1135x700	270x1135x700		
		kg(lbs)	43(95)	43(95)	43(95)	43(95)	45(99)		
	Outdoor	mm	650x830x320	830x900x330	1165x900x330	1165x900x330	1165x900x330		
		kg(lbs)	59(130)	69(152)	98(216)	94(207)	113(249)		
Piping Connections (Small / Large)			mm		9.52/15.88	9.52/15.88	9.52/15.88	9.52/15.88	9.52/19.05
Max Pipe Length (Chargeless)			m		25	30	50	50	50
Height Difference			m		15	15	30	30	30
Operation Range	Cooling	°CDB	0~43		0~43	0~43	0~43	0~43	
	Heating		-7~-24		-7~-24	-10~-24	-10~-24	-10~-24	
Refrigerant			R410A		R410A	R410A	R410A	R410A	

## Two-direction drain piping

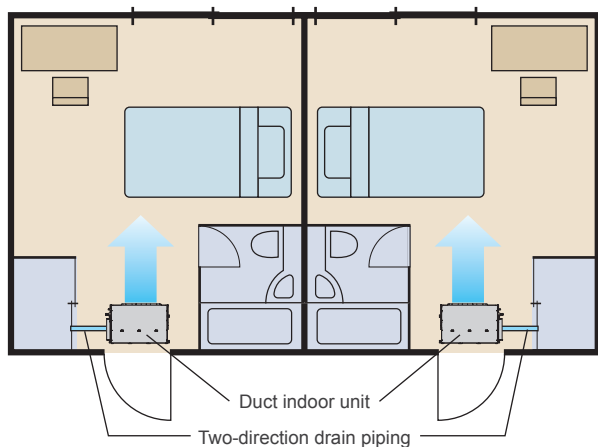

## Easy maintenance

See below for the case of rear suction type

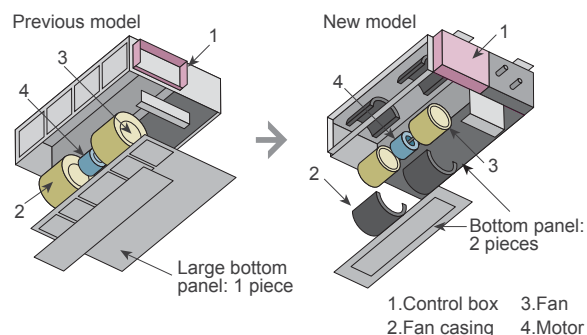

Structural improvement is attained by making the bottom panel two pieces, front and rear. The internal fan casing is also manufactured in two pieces, namely upper and lower. The maintenance of the motor and fan can be easily carried out by removing the rear panel and the lower part of the casing while leaving the main chassis installed.

## Installation styles

Embedded in Ceiling

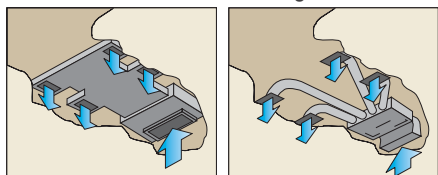

Hanging from Ceiling

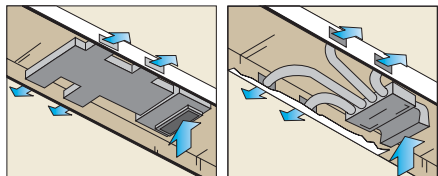

## Optional parts

Remote Sensor Unit:	UTD-RS100
Drain Pump Unit:	UTZ-PX1NBA
External Control Set:	UTD-ECS5A

## Dimensions

Models: ARY25UU / ARY30UU / ARY36U(1) / ARY36UU / ARY45UU

(Unit : mm)

\*Service accessibility must be allowed for when installing the product.

Please consult the installation manual for the necessary service access size.

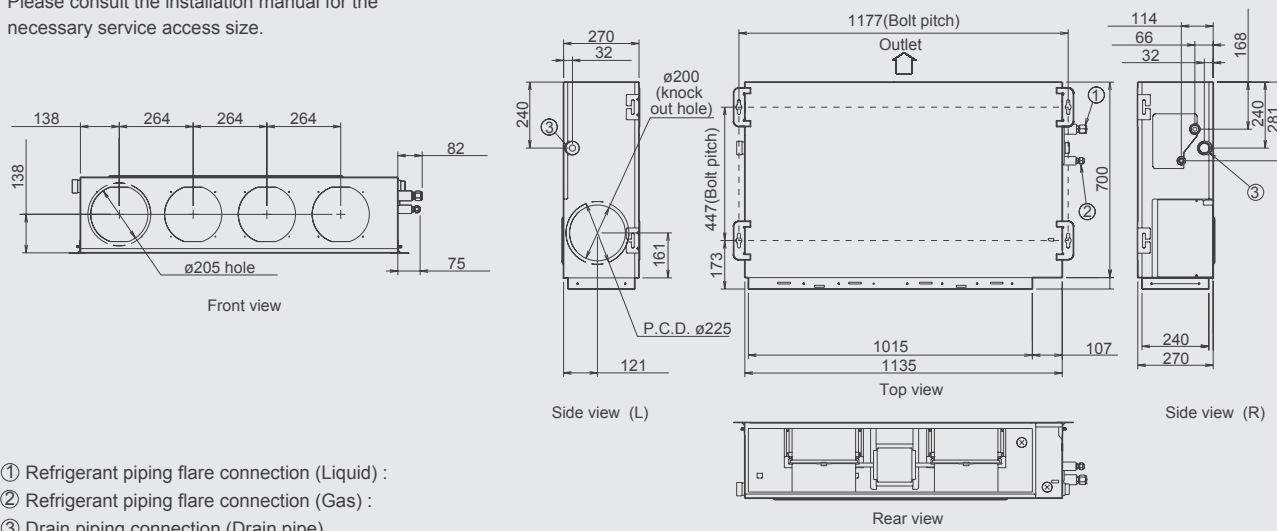

- ① Refrigerant piping flare connection (Liquid) :
- ② Refrigerant piping flare connection (Gas) :
- ③ Drain piping connection (Drain pipe)

# INVERTER

## High Static Pressure Duct



### Easy installation (Compact size & Lightweight)

A compact size and lightweight indoor unit has been developed by reducing the basic chassis and the overall material weight.

Volume  
**47.5%**  
down

Weight  
**40%**  
down

(unit: mm)

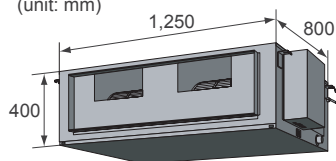

Previous model : 75kg

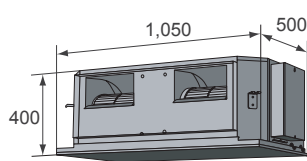

New model : 46kg (ARYC45LC/54LC)

### Specifications

Model No.	Indoor unit		ARY45LH	ARYC45LC	ARY54LU	ARYC54LC
	Outdoor unit		AOY45LH	AOYD45LA	AOY54LU	AOYD54LA
Power Source	V/Ø/Hz		230/1/50	400/3/50	230/1/50	400/3/50
Capacity	Cooling	kW	12.50	12.50	14.00	14.00
	Heating	kW	14.00	14.00	16.00	16.00
Input Power	Cooling/Heating	kW	4.30/3.80	4.06/3.67	5.36/4.70	4.65/4.37
EER - Energy Class	Cooling	W/W	2.91	3.08-B	2.61	3.01-B
COP - Energy Class	Heating		3.68	3.81-A	3.40	3.66-A
Running Current	Cooling/Heating	A	18.9/16.7	6.1/5.5	23.6/20.6	6.9/6.5
Moisture Removal		l/h	3.0	1.5	4.0	2.5
Noise (Indoor)	Cooling   H/M/L	dB(A)	49/45/42	47/43/40	49/45/42	47/43/40
Noise (Outdoor)	Cooling		54	54	54	55
Airflow Rate (High)	Indoor/Outdoor	m³/h	3500/6600	3350/6900	3500/6600	3350/6900
Net Dimension H x W x D	Indoor	mm	400x1050x500	400x1050x500	400x1050x500	400x1050x500
		kg(lbs)	50(110)	46(101)	50(110)	46(101)
	Outdoor	mm	1290x900x330	1290x900x330	1290x900x330	1290x900x330
		kg(lbs)	105(231)	107(236)	105(231)	107(236)
Piping Connections (Small / Large)		mm	9.52/15.88	9.52/15.88	9.52/15.88	9.52/15.88
Drain Pipe Diameter (Inner/Outer)		mm	21.5/25.4	23.4/25.4	21.5/25.4	23.4/25.4
Max Pipe Length (Chargeless)		m	70	75	70	75
Height Difference			30	30	30	30
Operation Range	Cooling	°CDB	-15~43	-15~46	-15~43	-15~46
	Heating		-15~24	-15~24	-15~24	-15~24
Refrigerant			R410A	R410A	R410A	R410A

### Design also corresponding to high static pressure

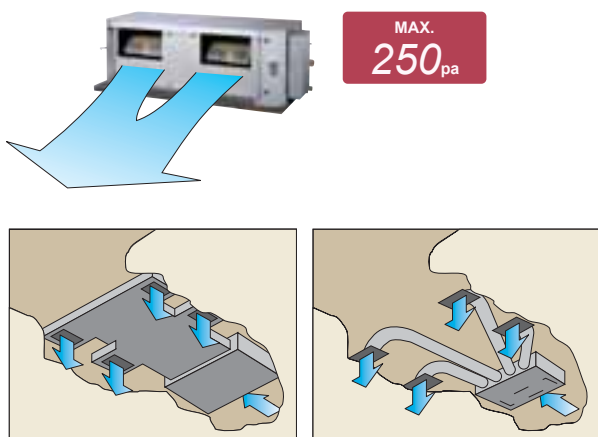

### Low noise

Cutting off the corners of the conventional indoor unit front panel and fan casing, has enabled less turbulent air flow. Low noise is realized by adopting a plastic case and a plastic fan.

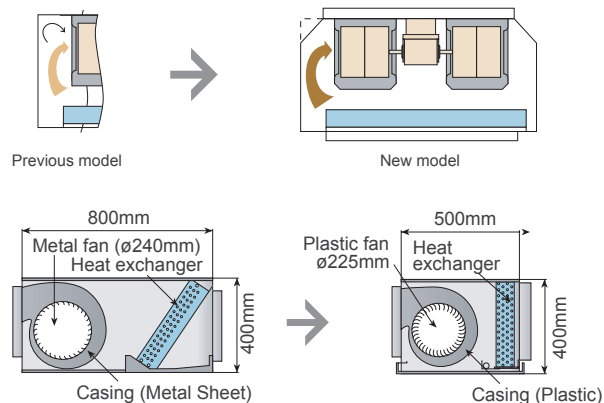

Previous model :  
Metal fan [53.1dB(A)]

\* Model : Material (At 100Pa : Actual noise measurement value)

New model :  
Plastic fan [45dB(A)]

### Low ambient operation (ARYC45LC/54LC)

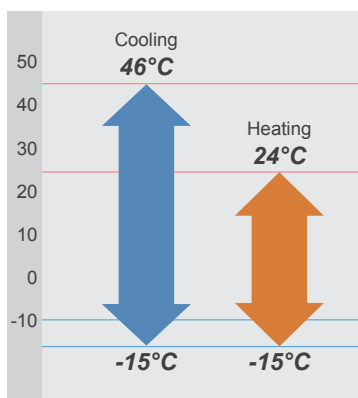

### Optional parts

Long-Life Filter UTD-LF60KA

### Dimensions

Models: ARY45LH / ARY54LU  
ARYC45LC / ARY54LC

(Unit : mm)

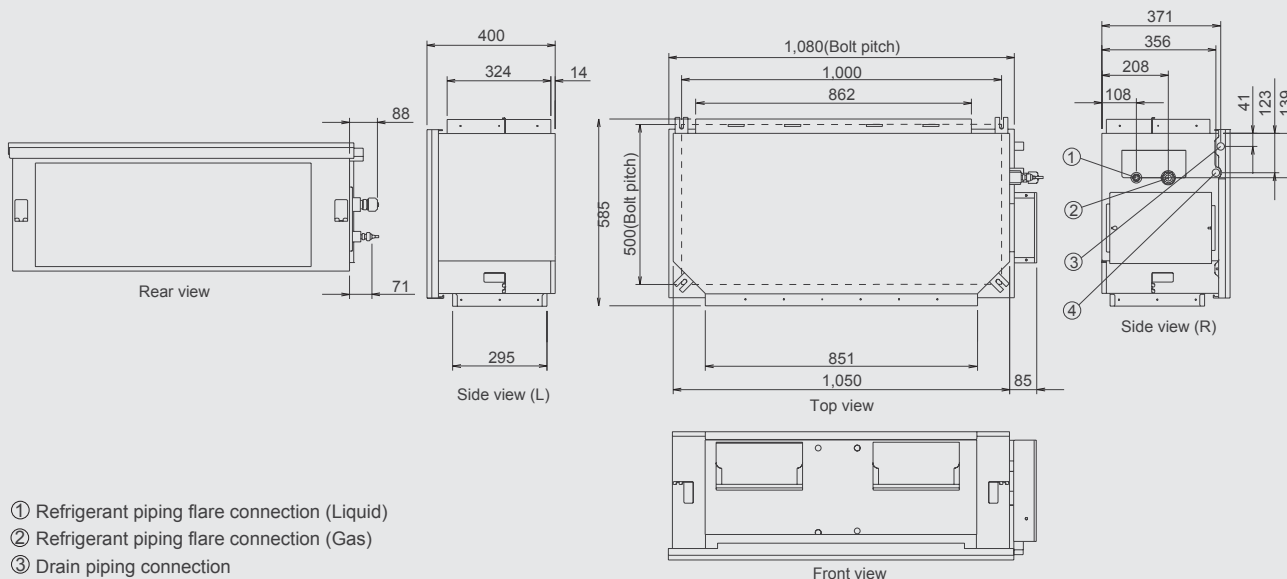

- ① Refrigerant piping flare connection (Liquid)
- ② Refrigerant piping flare connection (Gas)
- ③ Drain piping connection

# High Static Pressure Duct



Design also corresponding to high static pressure

Model: ARY90TL



MAX.  
300<sub>pa</sub>

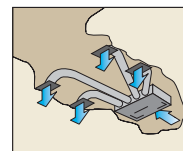
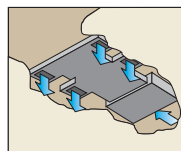

## Specifications

Model No.	Indoor unit		ARY60UU	ARY90TL
	Outdoor unit		AOY60UU	AOY90TL
Power Source	V/Ø/Hz		400/3/50	380-415/3/50
Capacity	Cooling	kW	16.50	24.80-25.40
	Heating		19.50	28.90-29.50
Input Power	Cooling/Heating	kW	6.06/5.54	12.2/12.2
EER - Energy Class	Cooling	W/W	2.72	2.03-2.03
COP - Energy Class	Heating		3.52	2.37-2.36
Running Current	Cooling/Heating	A	10.2/9.8	19.5/19.5
Moisture Removal		l/h	4.0	7.5
Noise (Indoor)	Cooling   H/M/L	dB(A)	49/45/42	50
Noise (Outdoor)	Cooling		54	59
Airflow Rate (High)	Indoor/Outdoor	m³/h	3500/6300	4300/9800
Net Dimension H x W x D	Indoor	mm	400x1050x500	450x1550x700
		kg(lbs)	50(110)	85(187)
	Outdoor	mm	1290x900x330	1380x1300x650
		kg(lbs)	118(260)	245(540)
Piping Connections (Small / Large)		mm	9.52/19.05	12.70/28.58
Max Pipe Length (Chargeless)		m	50	50
Height Difference			30	30
Operation Range	Cooling	°CDB	0~43	0~46
	Heating		-10~24	-10~21
Refrigerant			R410A	R407C

\*The measurement static pressure of ARY60UU is 100Pa and ARY90TL is 196Pa.



### Low noise

Turbulent air flow is reduced by cutting off the corners of conventional indoor unit front panel and fan case

Low noise is realized by adopting plastic case, plastic fan.

### Plastic fan [45dB(A)] (ARY60UU)

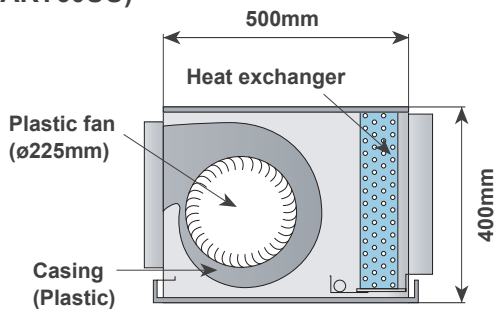

(ARY60UU)

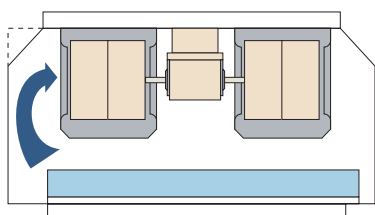

\* Model : Material (At 100Pa :  
Actual noise measurement value)

### Pursuance of amenity performance

Various remote controllers and sensors can be selected

#### 1.Wired Remote Controller with Thermo Sensor

- Room temperature sensor selection
- WEEKLY timer
- Temperature SET BACK timer
- Group control system
- Child lock
- Dual remote controllers
- <Optional parts>
- AUTO restart
- Energy saving
- Auto changeover <for heating>
- Hot start <for heating>

#### 2.Simple Remote Controller (Optional Parts)

#### 3.Remote Sensor (Optional Parts)

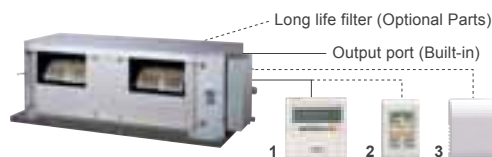

### Optional parts

- |                       |                          |
|-----------------------|--------------------------|
| Long-Life Filter:     | UTD-LF60KA (For ARY60UU) |
| Remote Sensor Unit:   | UTD-RS100                |
| External Control Set: | UTD-ECS5A (For ARY60UU)  |

## Dimensions

(Unit : mm)

Model: ARY60UU

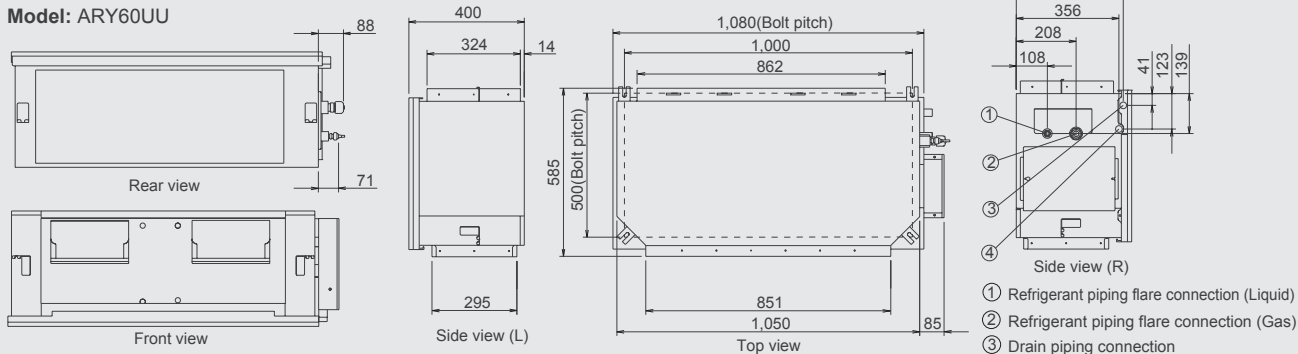

Model: ARY90TL

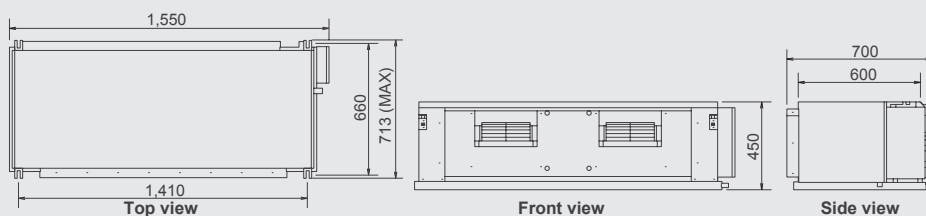

# Multi Split



Control several indoor units with one outdoor unit.  
Build the optimum system you desire.

If you want to keep a large floor as well as many rooms comfortable, we recommend you use Multi Split to build a simple system using one outdoor unit.

Choose from a large lineup the air conditioner types that match your rooms.

You can mix and match them at will.

Build the system that is just right for you.

## Contents

062 2 & 3-4 Rooms

070 Simultaneous Multi

072 Big Multi



2&3-4 Rooms



*Multiple Rooms*  
**Comfortably**

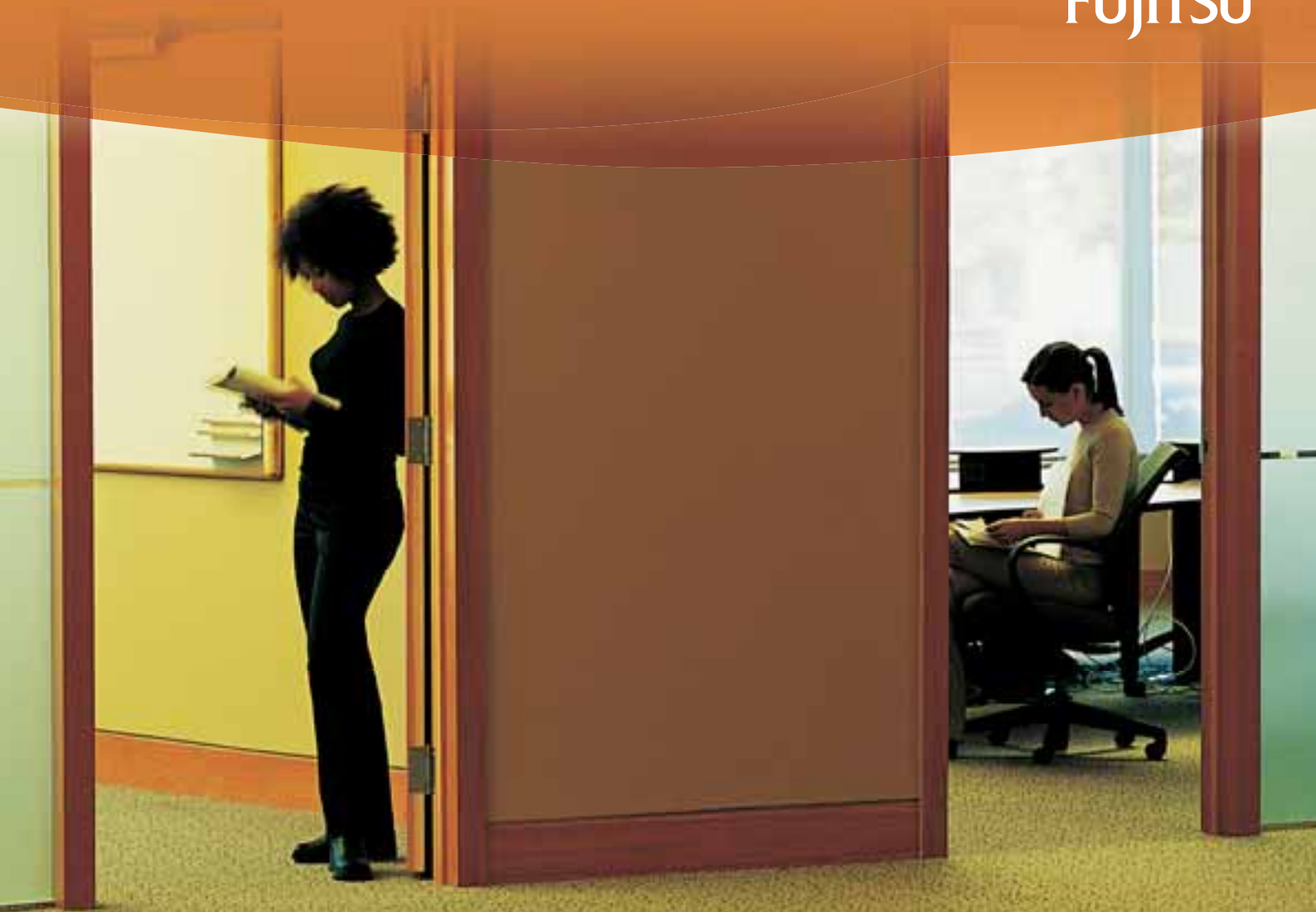

Multi Split provides comfort in a variety of situations from home to office and store.







**Multi Split type Air Conditioners**

FUJITSU GENERAL LIMITED

# INVERTER

## 2 & 3-4 Rooms Lineup

2 ROOMS	2 ROOMS	3 ROOMS	4 ROOMS
			
CLASS <b>A</b> ALL <b>DC</b>	CLASS <b>A</b>	CLASS <b>A</b> ALL <b>DC</b>	CLASS <b>A</b>
AOYA14LAC2 <b>NEW</b>	AOY18LMAK2 AOY24LMAM2	AOYA18LAT3 AOYA24LAT3	AOY30LMAW4

### Energy saving

High Efficiency DC Inverter Multi system permits energy saving operation and 40% higher efficiency than a Constant-Speed Multi system. Improved Inverter cooling ratio prevents decrease in capacity under overload operation.

#### Energy saving over a year's time

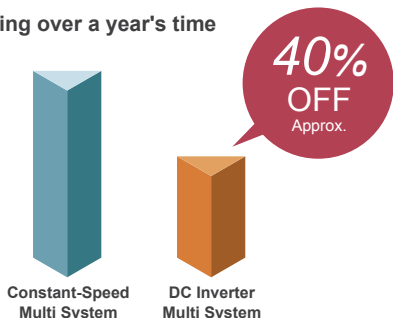

### DC twin rotary compressor (18~30)

Efficiency is improved over a wide range from high-speed rotation at high load up to the low-speed rotation region at low-load where long-term use is especially frequent, and high power is produced with little power consumption. Also, twin rotor provides low-vibration and quiet operation.

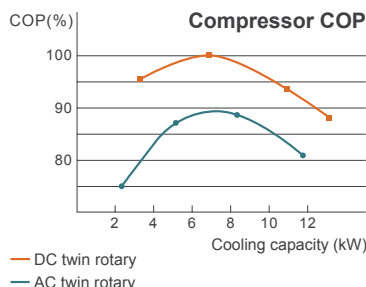

### Flexible installation

#### Max.Piping Length (Each Unit):

20m (AOYA14LAC2 / AOY18LMAK2 / 24LMAM2),

25m (AOYA18 / 24LAT3 / AOY30LMAW4)

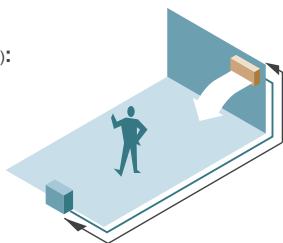

#### Max.Height:

10m (AOY18LMAK2 / 24LMAM2 / AOY30LMAW4),

15m (AOYA14LAC2 / AOYA18 / 24LAT3)

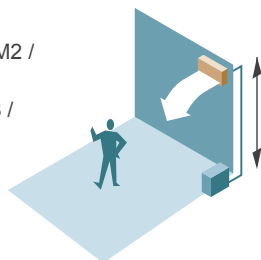

#### Total Piping Length:

30m (AOYA14LAC2 / AOY18LMAK2 / 24LMAM2),

50m (AOYA18 / 24LAT3),

70m (AOY30LMAW4)

### Select any type of air conditioners you like to suit the atmosphere of your room



### Indoor unit features



ASYA07/09/12LB	●		●	●	●	●			●	●	●	○	●	●	●
ASYA07/09/12/14/18LA	●		●	●	●				●	●	●		●	●	●
ASY24LB		●	●	●	●				●	●	●		●	●	●
AGYF09/12/14LA	●		●	●	●	●			●	●	●	○	●	●	●
AUYF09/12/14/18LA(B)	●		●	●	●		●		●	●	●	○			
ABYF14/18/24LB		●	●	●	●				●	●	●	○			
ARYF09/12/14/18/22LA(B)			●	●	●			○	●	○		●			

○: Optional function

### Connectable Indoor unit lineup

Indoor unit	kW	AOYA14LAC2	AOY18LMAK2	AOY24LMAM2	AOYA18LAT3	AOYA24LAT3	AOY30LMAW4
 ASYA07/09/12LB	2.1	●					
	2.5	●					
	3.5	●					
 ASYA07/09/12/14/18LA	2.3		●	●	●	●	●
	2.7		●	●	●	●	●
	3.5		●	●	●	●	●
	4.2		●	●	●	●	●
	5.0			●		●	●
 ASY24LB	6.8						●
 AGYF09/12/14LA	2.7		●	●	●	●	●
	3.5		●	●	●	●	●
	4.2		●	●	●	●	●
 AUYF09/12/14/18LA(B)	2.5		●	●	●	●	●
	3.5		●	●	●	●	●
	4.2		●	●	●	●	●
	5.2			●		●	●
 ABYF14/18/24LB	4.2		●	●	●	●	●
	5.2			●		●	●
	6.8						●
 ARYF09LA	2.7		●	●	●	●	●
 ARYF12/14/18/22LA(B)	3.5		●	●	●	●	●
	4.2		●	●	●	●	●
	5.2			●		●	●
	6.3			●		●	●

## 2 & 3-4 Rooms

### Specifications

#### SPECIFICATIONS (WALL MOUNTED TYPE)

Model No.	Indoor unit		ASYA07LA	ASYA09LA	ASYA12LA	ASYA14LA	ASYA18LA	ASYA24LB
Power Source	V/∅/Hz		230/1/50	230/1/50	230/1/50	230/1/50	230/1/50	230/1/50
Noise	Cooling	H/M/L/Q	35/32/27/21	38/33/28/22	39/34/28/23	45/38/33/26	45/38/34/28	47/41/36/32
Air Flow (High)			500	550	580	700	660	1020
Net Dimension H x W x D	mm		275x790x215	275x790x215	275x790x215	275x790x215	275x790x215	320x1120x220
Weight	kg(lbs)		9(20)	9(20)	9(20)	9(20)	9(20)	16(35)

#### SPECIFICATIONS (WALL MOUNTED TYPE)

Model No.	Indoor unit		ASYA07LB	ASYA09LB	ASYA12LB
Power Source	V/∅/Hz		230/1/50	230/1/50	230/1/50
Noise	Cooling	H/M/L/Q	38/36/33/21	38/36/33/21	43/38/33/21
Air Flow (High)			620	620	750
Net Dimension H x W x D	mm		260x790x198	260x790x198	260x790x198
Weight	kg(lbs)		7.5(17)	7.5(17)	7.5(17)

#### SPECIFICATIONS (FLOOR TYPE, FLOOR/CEILING UNIVERSAL TYPE)

Model No.	Indoor unit		AGYF09LA	AGYF12LA	AGYF14LA	ABYF14LA	ABYF18LB	ABYF24LB
Power Source	V/∅/Hz		230/1/50	230/1/50	230/1/50	230/1/50	230/1/50	230/1/50
Noise	Cooling	H/M/L/Q	39/34/28/22	42/36/30/22	44/38/31/22	36/34/33/29(Under ceiling) 39/37/36/32(Floor console)	41/38/34/32(Under ceiling) 44/41/37/35(Floor console)	45/40/36/33(Under ceiling) 48/43/39/36(Floor console)
Air Flow (High)			530	600	650	640	780	880
Net Dimension H x W x D	mm		600x740x200	600x740x200	600x740x200	199x990x655	199x990x655	199x990x655
Weight	kg(lbs)		14(30.7)	14(30.7)	14(30.7)	27(60)	27(60)	27(60)

#### SPECIFICATIONS (COMPACT CASSETTE TYPE)

Model No.	Indoor unit		AUYF09LA	AUYF12LA	AUYF14LA	AUYF18LB	
Power Source	V/∅/Hz		230/1/50	230/1/50	230/1/50	230/1/50	
Noise	Cooling	H/M/L/Q	33/31/29/26	37/33/31/27	40/35/32/27	42/37/33/27	
Air Flow (High)			540	610	680	750	
Net Dimension H x W x D	mm		245x570x570	245x570x570	245x570x570	245x570x570	
Weight	kg(lbs)		15(33.1)	15(33.1)	15(33.1)	15(33.1)	
Panel	UTG-UFYB-W						

#### SPECIFICATIONS (COMPACT DUCT TYPE)

Model No.	Indoor unit		ARYF09LA	ARYF12LA	ARYF14LA	ARYF18LB	ARYF22LA
Power Source	V/∅/Hz		230/1/50	230/1/50	230/1/50	230/1/50	230/1/50
Noise	Cooling	H/M/L/Q	35/33/31/30	30/29/26/25	33/30/27/24	34/32/30/29	40/36/33/30
Air Flow (High)			480	630	820	850	1060
Net Dimension H x W x D	mm		217x663x595	217x953x595	217x953x595	217x953x595	217x953x595
Weight	kg(lbs)		18(40)	23(51)	23(51)	23(51)	23(51)

#### SPECIFICATIONS (2 ROOMS, 3 ROOMS, 4 ROOMS)

Model No.	Outdoor unit		AOYA14LAC2	AOY18LMAK2	AOY24LMAM2	AOYA18LAT3	AOYA24LAT3	AOY30LMAW4
Power Source	V/∅/Hz		230/1/50	230/1/50	230/1/50	230/1/50	230/1/50	230/1/50
Noise	Cooling	H/M/L/Q	47	49	49	46	48	50
Net Dimension H x W x D	mm		540 x 790 x 290	650x830x320	650x830x320	700x900x330	700x900x330	830x900x330
Weight	kg(lbs)		37(82)	56(123)	56(123)	55(121)	55(121)	68(150)
Piping Connections (Small / Large)	mm		6.35/9.52	6.35/9.52 6.35/*12.70	6.35/9.52 6.35/*12.70	6.35/9.52x2 6.35/*12.70	6.35/9.52x2 6.35/*12.70	6.35/9.52x2 6.35/*12.70x2
Max Pipe Length	mm		30 (Total)	30 (Total)	30 (Total)	50 (Total)	50 (Total)	70 (Total)
Max Height Difference	mm		15 (Each)	10 (Each)	10 (Each)	15 (Each)	15 (Each)	10 (Each)
Operation Range	Cooling	°CDB	10~46	0~46	0~46	-10~46	-10~46	0~46
	Heating	°CDB	-15~24	-10~24	-10~24	-15~24	-15~24	-10~24
Refrigerant			R410A	R410A	R410A	R410A	R410A	R410A

\* Connect to connection valve by the adapter.



## Dimensions

### 2 ROOMS

Model: AOYA14LAC2

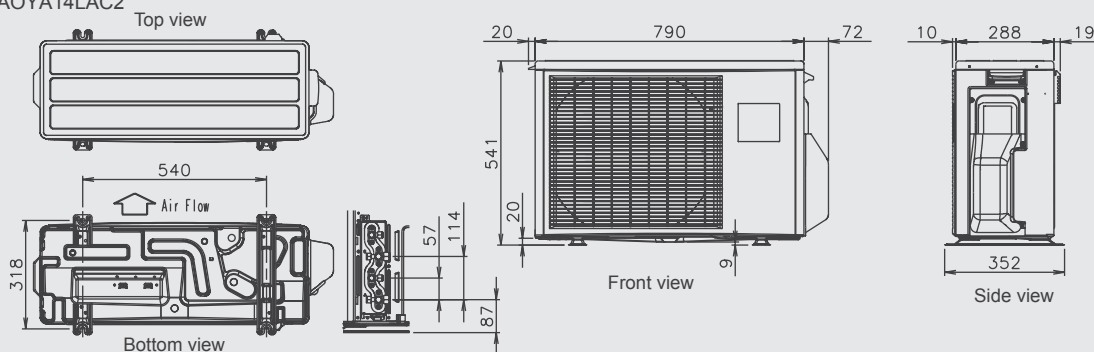

Models: AOY18LMAK2 / AOY24LMAM2

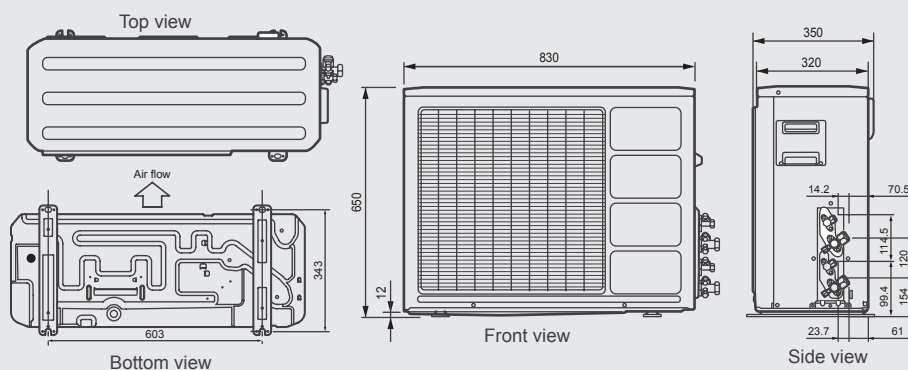

### 3 ROOMS

Models: AOYA18LAT3 / AOYA24LAT3

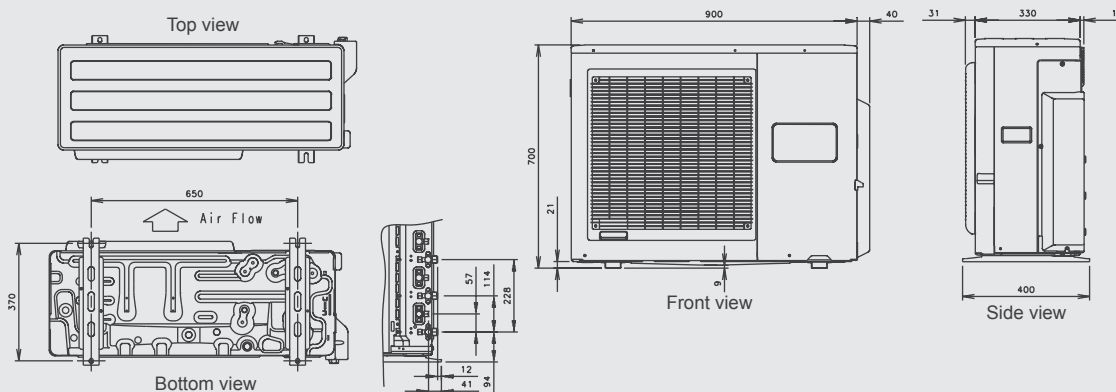

### 4 ROOMS

Models: AOY30LMAW4

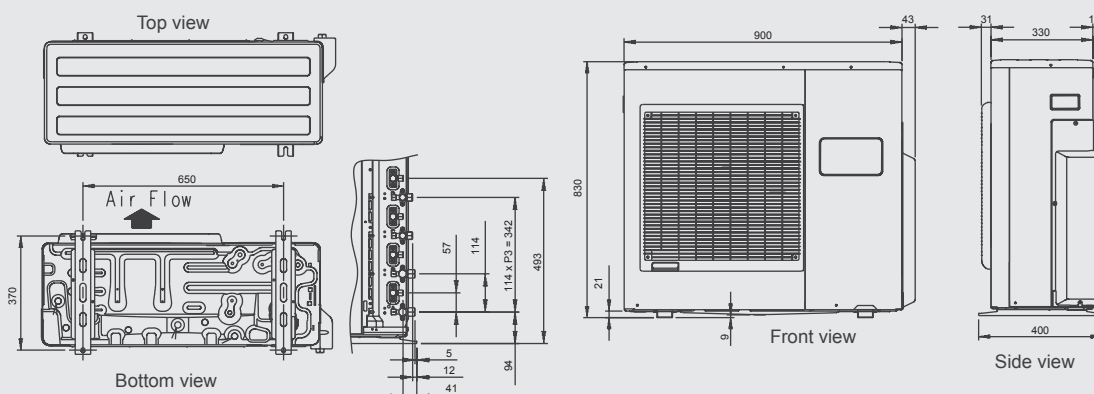

# 2 & 3-4 Rooms Combination tables

AOYA14LAC2	Indoor model for each room		COOLING OPERATION					EER	Cooling class
			COOLING OPERATION			Power Input			
			Room 1	Room 2	Total				
		KW	KW	KW	KW				
1 Room	7	-	2.10	-	2.10	0.59	3.56	A	
	9	-	2.50	-	2.50	0.65	3.85	A	
	12	-	3.50	-	3.50	1.04	3.37	A	
2 Room	7	7	2.30	2.00	4.00	1.09	3.67	A	
	7	9	1.95	2.05	4.00	1.09	3.67	A	
	7	12	1.65	2.35	4.00	1.05	3.81	A	
	9	9	2.00	2.00	4.00	1.09	3.67	A	
	9	12	1.70	2.30	4.00	1.05	3.81	A	
	9	12	1.70	2.30	4.00	1.05	3.81	A	

AOY18LMAK2	Indoor model for each room		COOLING OPERATION					EER	Cooling class
			COOLING OPERATION			Power Input			
			Room 1	Room 2	Total				
		KW	KW	KW	KW				
1 Room	7	-	2.30	-	2.30(2.0-2.7)	0.71(0.65-0.90)	3.24	A	
	9	-	2.70	-	2.70(2.0-3.2)	0.89(0.65-1.07)	3.03	B	
	12	-	3.50	-	3.50(2.0-4.0)	1.09(0.65-1.33)	3.21	A	
	14	-	4.20	-	4.20(2.0-4.8)	1.30(0.65-1.60)	3.23	A	
2 Room	7	7	2.30	2.30	4.60(2.0-5.4)	1.39(0.68-1.68)	3.31	A	
	7	9	2.35	2.75	5.10(2.0-5.9)	1.56(0.68-1.84)	3.27	A	
	7	12	2.18	3.32	5.50(2.0-6.3)	1.65(0.68-2.03)	3.33	A	
	7	14	1.95	3.55	5.50(2.0-6.5)	1.65(0.68-2.40)	3.33	A	
	9	9	2.70	2.70	5.40(2.0-6.3)	1.65(0.68-2.06)	3.27	A	
	9	12	2.40	3.10	5.50(2.0-6.5)	1.65(0.68-2.40)	3.33	A	
	9	14	2.15	3.35	5.50(2.0-6.5)	1.65(0.68-2.40)	3.33	A	
	12	12	2.75	2.75	5.50(2.0-6.5)	1.65(0.68-2.40)	3.33	A	

AOY24LMAM2	Indoor model for each room		COOLING OPERATION					EER	Cooling class
			COOLING OPERATION			Power Input			
			Room 1	Room 2	Total				
		KW	KW	KW	KW				
1 Room	7	-	2.30	-	2.30(2.0-2.7)	0.71(0.65-0.90)	3.24	A	
	9	-	2.70	-	2.70(2.0-3.2)	0.89(0.65-1.07)	3.03	B	
	12	-	3.50	-	3.50(2.0-4.0)	1.09(0.65-1.33)	3.21	A	
	14	-	4.20	-	4.20(2.0-4.8)	1.30(0.65-1.60)	3.23	A	
	18	-	5.00	-	5.00(2.0-5.6)	1.64(0.68-1.95)	3.05	B	
2 Room	7	7	2.30	2.30	4.60(2.0-5.4)	1.39(0.68-1.68)	3.31	A	
	7	9	2.35	2.75	5.10(2.0-5.9)	1.56(0.68-1.84)	3.27	A	
	7	12	2.18	3.32	5.50(2.0-6.3)	1.71(0.68-2.03)	3.22	A	
	7	14	2.02	3.68	5.70(2.0-7.3)	1.72(0.68-2.62)	3.31	A	
	7	18	1.80	3.90	5.70(2.0-7.6)	1.72(0.68-2.87)	3.31	A	
	9	9	2.70	2.70	5.40(2.0-6.3)	1.68(0.68-2.06)	3.21	A	
	9	12	2.44	3.16	5.60(2.0-7.0)	1.71(0.68-2.58)	3.27	A	
	9	14	2.23	3.47	5.70(2.0-7.6)	1.72(0.68-2.87)	3.31	A	
	9	18	2.00	3.70	5.70(2.5-7.7)	1.72(0.80-2.87)	3.31	A	
	12	12	2.80	2.80	5.60(2.0-7.3)	1.72(0.68-2.87)	3.26	A	
	12	14	2.59	3.11	5.70(2.0-7.6)	1.73(0.68-2.87)	3.29	A	
	12	18	2.39	3.41	5.80(2.5-7.8)	1.73(0.80-2.87)	3.35	A	
	14	14	2.90	2.90	5.80(2.5-7.8)	1.73(0.80-2.87)	3.35	A	

AOYA18LAT3	Indoor model for each room		COOLING OPERATION					EER	Cooling class
			COOLING OPERATION				Power Input		
			Room 1	Room 2	Room 3	Total			
		KW	KW	KW	KW	KW			
1 Room	7	-	2.30	-	-	2.30(1.5-2.7)	0.65(0.45-0.75)	3.54	A
	9	-	2.70	-	-	2.70(1.5-3.3)	0.80(0.45-1.09)	3.38	A
	12	-	3.50	-	-	3.50(1.5-3.7)	1.09(0.45-1.15)	3.21	A
	14	-	4.20	-	-	4.20(1.5-4.8)	1.16(0.45-1.41)	3.62	A
	18	-	5.00	-	-	5.00(1.8-5.6)	1.50(0.50-1.96)	3.33	A
2 Room	7	7	2.30	2.30	-	4.60(1.8-5.0)	1.20(0.50-1.40)	3.83	A
	7	9	2.30	2.30	-	5.00(1.8-5.7)	1.36(0.50-1.78)	3.68	A
	7	12	2.30	1.80	-	5.80(1.8-6.1)	1.70(0.50-1.97)	3.41	A
	7	14	2.30	2.37	-	6.50(1.8-7.2)	1.91(0.50-2.46)	3.40	A
	7	18	2.30	2.08	-	6.60(1.8-7.8)	1.91(0.50-2.87)	3.46	A
	9	9	2.75	2.75	-	5.50(1.8-6.2)	1.55(0.50-2.02)	3.55	A
	9	12	2.79	2.79	-	6.20(1.8-6.8)	1.90(0.50-2.45)	3.26	A
	9	14	3.94	2.66	-	6.60(1.8-7.7)	1.91(0.50-2.77)	3.46	A
	9	18	4.35	2.35	-	6.70(1.8-7.9)	1.91(0.50-2.87)	3.51	A
	12	12	3.15	3.15	-	6.30(1.8-7.2)	1.90(0.50-2.74)	3.32	A
	14	12	3.67	3.03	-	6.70(1.8-7.8)	1.91(0.50-2.87)	3.51	A
	3 Room	7	7	2.27	2.27	-	6.80(1.8-7.4)	1.92(0.50-2.37)	3.54
7		7	2.52	2.14	2.14	6.80(1.8-7.8)	1.93(0.50-2.60)	3.52	A
7		7	2.84	1.98	1.98	6.80(1.8-8.1)	1.93(0.50-2.87)	3.52	A
7		7	3.16	1.82	1.82	6.80(2.0-8.4)	1.94(0.60-2.87)	3.51	A
7		7	3.54	1.63	1.63	6.80(2.0-8.5)	1.94(0.60-2.87)	3.51	A
9		9	2.38	2.38	2.03	6.80(1.8-8.2)	1.93(0.50-2.87)	3.52	A
9		9	2.70	2.21	1.88	6.80(1.8-8.2)	1.93(0.50-2.87)	3.52	A
9		9	3.02	2.04	1.74	6.80(2.0-8.4)	1.94(0.60-2.87)	3.51	A
9		9	3.40	1.84	1.56	6.80(2.0-8.5)	1.94(0.60-2.87)	3.51	A
12		12	2.52	2.52	1.76	6.80(1.8-8.2)	1.94(0.50-2.87)	3.51	A
14		12	2.83	2.34	1.63	6.80(2.0-8.5)	1.94(0.60-2.87)	3.51	A
9		9	2.27	2.27	2.27	6.80(1.8-8.2)	1.94(0.50-2.87)	3.51	A
12		9	2.58	2.11	2.11	6.80(1.8-8.3)	1.94(0.50-2.87)	3.51	A
14		9	2.89	1.95	1.95	6.80(2.0-8.5)	1.94(0.60-2.87)	3.51	A
18		9	3.27	1.77	1.77	6.80(2.0-8.5)	1.94(0.60-2.87)	3.51	A
12		12	2.41	2.41	1.97	6.80(1.8-8.3)	1.94(0.50-2.87)	3.51	A
14		12	2.72	2.24	1.84	6.80(2.0-8.5)	1.94(0.60-2.87)	3.51	A
12		12	2.27	2.27	2.27	6.80(1.8-8.3)	1.94(0.50-2.87)	3.51	A

AOYA24LAT3	Indoor model for each room		COOLING OPERATION					EER	Cooling class	
			COOLING OPERATION				Power Input			
			Room 1	Room 2	Room 3	Total				
		KW	KW	KW	KW	KW				
1 Room	7	-	2.30	-	-	2.30(1.5-2.7)	0.65(0.45-0.75)	3.54	A	
	9	-	2.70	-	-	2.70(1.5-3.3)	0.80(0.45-1.09)	3.38	A	
	12	-	3.50	-	-	3.50(1.5-3.7)	1.09(0.45-1.15)	3.21	A	
	14	-	4.20	-	-	4.20(1.5-4.8)	1.16(0.45-1.41)	3.62	A	
	18	-	5.00	-	-	5.00(1.8-5.6)	1.50(0.50-1.96)	3.33	A	
2 Room	7	7	2.30	2.30	-	4.60(1.8-5.0)	1.20(0.50-1.40)	3.83	A	
	7	9	2.30	2.30	-	5.00(1.8-5.7)	1.36(0.50-1.78)	3.68	A	
	7	12	2.30	1.80	-	5.80(1.8-6.1)	1.70(0.50-1.97)	3.41	A	
	7	14	2.30	2.37	-	6.50(1.8-7.2)	1.91(0.50-2.46)	3.40	A	
	7	18	2.30	2.08	-	6.60(1.8-7.8)	1.91(0.50-2.87)	3.46	A	
	9	9	2.75	2.75	-	5.50(1.8-6.2)	1.55(0.50-2.02)	3.55	A	
	9	12	2.79	2.79	-	6.20(1.8-6.8)	1.90(0.50-2.45)	3.26	A	
	9	14	3.94	2.66	-	6.60(1.8-7.7)	1.91(0.50-2.77)	3.46	A	
	9	18	4.35	2.35	-	6.70(1.8-7.9)	1.91(0.50-2.87)	3.51	A	
	12	12	3.15	3.15	-	6.30(1.8-7.2)	1.90(0.50-2.74)	3.32	A	
	14	12	3.67	3.03	-	6.70(1.8-7.8)	1.91(0.50-2.87)	3.51	A	
	18	12	4.04	2.66	-	6.70(1.8-7.9)	1.92(0.50-2.87)	3.49	A	
	3 Room	7	7	2.27	2.27	-	6.80(1.8-7.4)	1.92(0.50-2.37)	3.54	A
		7	7	2.52	2.14	2.14	6.80(1.8-7.8)	1.93(0.50-2.60)	3.52	A
		7	7	2.84	1.98	1.98	6.80(1.8-8.1)	1.93(0.50-2.87)	3.52	A
		7	7	3.16	1.82	1.82	6.80(2.0-8.4)	1.94(0.60-2.87)	3.51	A
		7	7	3.54	1.63	1.63	6.80(2.0-8.5)	1.94(0.60-2.87)	3.51	A
		9	9	2.38	2.38	2.03	6.80(1.8-8.2)	1.93(0.50-2.87)	3.52	A
9		9	2.70	2.21	1.88	6.80(1.8-8.2)	1.93(0.50-2.87)	3.52	A	
9		9	3.02	2.04	1.74	6.80(2.0-8.4)	1.94(0.60-2.87)	3.51	A	
9		9	3.40	1.84	1.56	6.80(2.0-8.5)	1.94(0.60-2.87)	3.51	A	
12		12	2.52	2.52	1.76	6.80(1.8-8.2)	1.94(0.50-2.87)	3.51	A	
14		12	2.83	2.34	1.63	6.80(2.0-8.5)	1.94(0.60-2.87)	3.51	A	
9		9	2.27	2.27	2.27	6.80(1.8-8.2)	1.94(0.50-2.87)	3.51	A	
12		9	2.58	2.11	2.11	6.80(1.8-8.3)	1.94(0.50-2.87)	3.51	A	
14		9	2.89	1.95	1.95	6.80(2.0-8.5)	1.94(0.60-2.87)	3.51	A	
18		9	3.27	1.77	1.77	6.80(2.0-8.5)	1.94(0.60-2.87)	3.51	A	
12		12	2.41	2.41	1.97	6.80(1.8-8.3)	1.94(0.50-2.87)	3.51	A	
14		12	2.72	2.24	1.84	6.80(2.0-8.5)	1.94(0.60-2.87)	3.51	A	
12		12	2.27	2.27	2.27	6.80(1.8-8.3)	1.94(0.50-2.87)	3.51	A	

Note: \*Indoor unit combinations shown here are the patterns of units operating, not patterns of units connectable.  
 \*Cooling capacity is based on 27°CDB/19°CWB (indoor temperature), 35°CDB (outdoor temperature).  
 \*Heating capacity is based on 20°CDB (indoor temperature), 7°CDB/6°CWB (outdoor temperature).

AOYA14LAC2	Indoor model for each room		HEATING OPERATION					COP	Heating class
			HEATING OPERATION			Power Input			
			Room 1	Room 2	Total				
			KW	KW	KW	KW			
1 Room	7	-	2.70	-	2.70	0.64	4.22	A	
	9	-	3.30	-	3.30	0.87	3.79	A	
	12	-	4.00	-	4.00	1.13	3.54	A	
2 Room	7	7	2.20	2.20	4.40	1.03	4.27	A	
	7	9	2.15	2.25	4.40	1.03	4.27	A	
	7	12	1.95	2.45	4.40	1.02	4.31	A	
	9	9	2.20	2.20	4.40	1.03	4.27	A	
	9	12	2.00	2.40	4.40	1.02	4.31	A	
	9	12	2.00	2.40	4.40	1.02	4.31	A	

AOY18LMAK2	Indoor model for each room		HEATING OPERATION					COP	Heating class
			HEATING OPERATION			Power Input			
			Room 1	Room 2	Total				
			KW	KW	KW	KW			
1 Room	7	-	2.70	-	2.70(2.2-3.3)	0.82(0.65-1.01)	3.29	C	
	9	-	3.30	-	3.30(2.2-4.2)	0.99(0.65-1.26)	3.33	C	
	12	-	4.00	-	4.00(2.2-4.8)	1.20(0.65-1.47)	3.33	C	
	14	-	4.80	-	4.80(2.2-6.0)	1.43(0.65-1.87)	3.36	C	
2 Room	7	7	2.60	2.60	5.20(2.2-6.4)	1.34(0.68-1.75)	3.88	A	
	7	9	2.85	3.35	6.20(2.2-7.3)	1.65(0.68-2.22)	3.76	A	
	7	12	2.59	3.71	6.30(2.2-7.7)	1.65(0.68-2.40)	3.82	A	
	7	14	2.36	4.04	6.40(2.5-7.8)	1.66(0.75-2.40)	3.86	A	
	9	9	3.15	3.15	6.30(2.2-7.7)	1.65(0.68-2.22)	3.82	A	
	9	12	2.85	3.45	6.30(2.2-7.8)	1.65(0.75-2.40)	3.82	A	
	9	14	2.61	3.79	6.40(2.5-7.8)	1.65(0.75-2.40)	3.88	A	
	12	12	3.15	3.15	6.30(2.2-7.8)	1.65(0.75-2.40)	3.82	A	

AOY24LMAM2	Indoor model for each room		HEATING OPERATION					COP	Heating class
			HEATING OPERATION			Power Input			
			Room 1	Room 2	Total				
			KW	KW	KW	KW			
1 Room	7	-	2.70	-	2.70(2.2-3.3)	0.82(0.65-1.01)	3.29	C	
	9	-	3.30	-	3.30(2.2-4.2)	0.99(0.65-1.26)	3.33	C	
	12	-	4.00	-	4.00(2.2-4.8)	1.20(0.65-1.47)	3.33	C	
	14	-	4.80	-	4.80(2.2-6.0)	1.43(0.65-1.87)	3.36	C	
2 Room	7	7	2.60	2.60	5.20(2.2-7.1)	1.87(0.68-2.64)	3.21	C	
	7	9	2.80	3.35	5.20(2.2-6.4)	1.34(0.68-1.75)	3.88	A	
	7	12	2.59	3.71	6.30(2.2-7.4)	1.70(0.68-2.22)	3.65	A	
	7	14	2.36	4.04	6.30(2.2-7.9)	1.69(0.68-2.41)	3.73	A	
	7	18	2.13	4.27	6.40(2.5-8.5)	1.67(0.75-2.68)	3.83	A	
	9	9	3.20	3.20	6.40(2.2-8.0)	1.70(0.68-2.47)	3.76	A	
	9	12	2.85	3.45	6.30(2.2-8.4)	1.68(0.75-2.70)	3.75	A	
	9	14	2.61	3.79	6.40(2.5-8.9)	1.66(0.75-2.87)	3.86	A	
	9	18	2.37	4.03	6.40(2.7-8.9)	1.64(0.80-2.87)	3.90	A	
	12	12	3.20	3.20	6.40(2.2-8.9)	1.67(0.75-2.87)	3.83	A	
	12	14	2.91	3.49	6.40(2.5-9.0)	1.65(0.80-2.87)	3.88	A	
	12	18	2.67	3.73	6.40(2.7-9.0)	1.64(0.80-2.87)	3.90	A	
	14	14	3.20	3.20	6.40(2.7-8.8)	1.64(0.80-2.87)	3.90	A	

AOYA18LAT3	Indoor model for each room		HEATING OPERATION					COP	Heating class
			HEATING OPERATION			Power Input			
			Room 1	Room 2	Room 3				
			KW	KW	KW	KW			
1 Room	7	-	2.70	-	-	2.70(1.5-3.3)	0.83(0.43-1.00)	3.25	C
	9	-	3.30	-	-	3.30(1.5-4.2)	1.00(0.42-1.30)	3.30	C
	12	-	3.80	-	-	3.80(1.5-4.8)	1.26(0.42-1.62)	3.02	D
	14	-	4.80	-	-	4.80(1.5-5.8)	1.30(0.42-1.70)	3.09	A
2 Room	7	7	2.70	2.70	-	5.40(2.0-6.1)	1.59(0.52-1.93)	3.40	C
	9	7	3.25	2.75	-	6.00(2.0-6.4)	1.87(0.52-2.06)	3.21	C
	12	7	3.71	2.59	-	6.30(2.0-6.5)	1.98(0.52-2.06)	3.18	D
	14	7	4.29	2.51	-	6.80(2.0-7.1)	1.92(0.50-2.06)	3.54	B
	9	9	3.15	3.15	-	6.30(2.0-6.5)	1.98(0.52-2.06)	3.18	D
	12	9	3.51	2.89	-	6.40(2.0-6.6)	1.99(0.52-2.06)	3.22	C
3 Room	14	9	4.03	2.77	-	6.80(2.0-7.2)	1.91(0.50-2.06)	3.56	B
	12	12	3.20	3.20	-	6.40(2.0-6.6)	1.98(0.52-2.06)	3.23	C
	14	12	3.71	3.09	-	6.80(2.0-7.3)	1.90(0.50-2.06)	3.58	B
	7	7	2.23	2.23	2.23	6.70(2.0-7.7)	1.70(0.50-2.06)	3.94	A
	9	7	2.52	2.14	2.14	6.80(2.0-7.8)	1.70(0.50-2.06)	4.00	A
	12	7	2.83	1.98	1.98	6.80(2.0-7.8)	1.69(0.50-2.06)	4.02	A
	14	7	3.14	1.83	1.83	6.80(2.0-8.0)	1.62(0.50-2.06)	4.20	A
	9	9	2.39	2.39	2.03	6.80(2.0-7.8)	1.69(0.50-2.06)	4.02	A
	12	9	2.69	2.22	1.89	6.80(2.0-7.9)	1.68(0.50-2.06)	4.05	A
	14	9	2.99	2.06	1.75	6.80(2.0-8.0)	1.62(0.50-2.06)	4.20	A
	9	9	2.27	2.27	2.27	6.80(2.0-7.9)	1.68(0.50-2.06)	4.05	A
	12	9	2.57	2.12	2.12	6.80(2.0-7.9)	1.67(0.50-2.06)	4.07	A

AOYA24LAT3	Indoor model for each room		HEATING OPERATION					COP	Heating class
			HEATING OPERATION			Power Input			
			Room 1	Room 2	Room 3				
			KW	KW	KW	KW			
1 Room	7	-	2.70	-	-	2.70(1.5-3.3)	0.83(0.43-1.00)	3.25	C
	9	-	3.30	-	-	3.30(1.5-4.2)	1.00(0.42-1.30)	3.30	C
	12	-	3.80	-	-	3.80(1.5-4.8)	1.26(0.42-1.62)	3.02	D
	14	-	4.80	-	-	4.80(1.5-5.8)	1.30(0.42-1.70)	3.09	A
2 Room	18	-	6.00	-	-	6.00(1.6-7.1)	1.85(0.42-2.40)	3.24	C
	7	7	2.75	2.75	-	5.50(2.0-6.1)	1.55(0.52-1.93)	3.55	B
	9	7	3.30	2.80	-	6.10(2.0-7.0)	1.82(0.52-2.52)	3.35	C
	12	7	4.12	2.88	-	7.00(2.0-7.3)	2.31(0.52-2.66)	3.03	D
	14	7	4.80	2.80	-	7.60(2.0-8.3)	2.28(0.50-2.87)	3.33	C
	18	7	5.39	2.51	-	7.90(2.0-8.3)	2.34(0.50-2.87)	3.38	C
	9	9	3.30	3.30	-	6.60(2.0-7.4)	2.04(0.52-2.68)	3.24	C
	12	9	4.00	3.30	-	7.30(2.0-7.7)	2.43(0.52-2.87)	3.00	D
	14	9	4.68	3.22	-	7.90(2.0-8.3)	2.38(0.50-2.87)	3.32	C
	18	9	5.16	2.84	-	8.00(2.0-8.5)	2.32(0.50-2.87)	3.45	B
	12	12	3.80	3.80	-	7.60(2.0-7.8)	2.54(0.52-2.87)	2.99	D
	14	12	4.31	3.59	-	7.90(2.0-8.4)	2.37(0.50-2.87)	3.33	C
	18	12	4.80	3.20	-	8.00(2.0-8.8)	2.31(0.50-2.87)	3.46	B
	3 Room	7	7	2.47	2.47	2.47	7.40(2.0-8.6)	2.05(0.50-2.68)	3.61
9		7	2.86	2.42	2.42	7.70(2.0-8.8)	2.11(0.50-2.87)	3.65	A
12		7	3.25	2.28	2.28	7.80(2.0-8.9)	2.10(0.50-2.80)	3.71	A
14		7	3.65	2.13	2.13	7.90(2.0-9.2)	2.02(0.50-2.72)	3.91	A
18		7	4.09	1.91	1.91	7.90(2.0-9.2)	2.00(0.50-2.70)	3.95	A
9		9	2.74	2.74	2.32	7.80(2.0-9.0)	2.10(0.50-2.87)	3.71	A
12		9	3.09	2.55	2.16	7.80(2.0-9.1)	2.09(0.50-2.87)	3.73	A
14		9	3.52	2.42	2.06	8.00(2.0-9.2)	2.02(0.50-2.72)	3.96	A
18		9	3.97	2.18	1.85	8.00(2.0-9.2)	2.00(0.50-2.69)	4.00	A
12		12	2.93	2.93	2.05	7.90(2.0-9.1)	2.08(0.50-2.87)	3.80	A
14		12	3.31	2.76	1.93	8.00(2.0-9.2)	2.01(0.50-2.70)	3.98	A
9		9	2.63	2.63	2.63	7.90(2.0-9.1)	2.09(0.50-2.87)	3.78	A
12		9	2.98	2.46	2.46	7.90(2.0-9.2)	2.08(0.50-2.87)	3.80	A
14		9	3.37	2.32	2.32	8.00(2.0-9.2)	2.00(0.50-2.70)	4.00	A
18		9	3.81	2.10	2.10	8.00(2.0-9.2)	1.98(0.50-2.68)	4.04	A
12		12	2.83	2.83	2.34	8.00(2.0-9.2)	2.07(0.50-2.80)	3.86	A
14		12	3.17	2.64	2.18	8.00(2.0-9.2)	2.00(0.50-2.69)	4.00	A
12		12	2.67	2.67	2.67	8.00(2.0-9.2)	2.06(0.50-2.78)	3.88	A

# 2 & 3-4 Rooms Combination tables

AOY30LMAW4	Indoor model for each room		COOLING OPERATION									
			COOLING OPERATION				Total	Power Input	EER	Cooling class		
			Room 1	Room 2	Room 3	Room 4					KW	KW
1 Room	7	-	-	-	2.30	-	-	-	2.30(1.6-2.7)	0.78(0.56-0.99)	2.95	C
	9	-	-	-	2.70	-	-	-	2.70(1.6-3.4)	0.94(0.56-1.25)	2.87	C
	12	-	-	-	3.50	-	-	-	3.50(1.6-3.8)	1.24(0.56-1.40)	2.82	C
	14	-	-	-	4.00	-	-	-	4.00(1.7-4.5)	1.40(0.57-1.68)	2.86	C
	18	-	-	-	5.20	-	-	-	5.20(1.7-6.0)	1.68(0.56-2.20)	3.10	B
	22	-	-	-	6.30	-	-	-	6.30(1.8-6.8)	2.30(0.58-2.70)	2.74	D
	24	-	-	-	6.80	-	-	-	6.80(1.8-7.4)	2.40(0.58-2.86)	2.83	C
	7	7	-	-	2.30	2.30	-	-	4.60(1.8-5.2)	1.42(0.60-1.62)	3.24	A
	9	7	-	-	2.70	2.30	-	-	5.00(1.8-6.0)	1.60(0.60-2.16)	3.13	B
	12	7	-	-	3.50	2.30	-	-	5.80(1.8-6.2)	2.00(0.60-2.20)	2.90	C
	14	7	-	-	4.00	2.30	-	-	6.30(1.8-7.1)	2.15(0.60-2.50)	2.93	C
	2 Room	18	7	-	-	4.80	2.10	-	-	6.90(2.8-8.2)	2.10(0.90-2.85)	3.29
22		7	-	-	5.20	1.90	-	-	7.10(2.8-8.9)	2.16(0.90-3.30)	3.29	A
24		7	-	-	5.40	1.90	-	-	7.20(2.8-9.3)	2.16(0.90-3.58)	3.33	A
9		9	-	-	2.70	2.70	-	-	5.40(1.8-6.4)	1.68(0.60-2.23)	3.21	A
12		9	-	-	3.50	2.70	-	-	6.20(2.8-6.8)	2.16(0.90-2.50)	2.87	C
14		9	-	-	4.00	2.70	-	-	6.70(2.8-7.8)	2.35(0.90-2.90)	2.85	C
18		9	-	-	4.60	2.40	-	-	7.00(2.8-7.7)	2.15(0.90-3.25)	3.26	A
22		9	-	-	5.00	2.10	-	-	7.10(2.8-9.0)	2.15(0.90-3.52)	3.30	A
24		9	-	-	5.23	2.07	-	-	7.30(2.8-9.5)	2.15(0.90-3.52)	3.40	A
12		12	-	-	3.35	3.35	-	-	6.70(2.8-7.3)	2.36(0.90-2.80)	2.84	C
14		12	-	-	3.68	3.22	-	-	6.90(2.8-8.5)	2.18(0.90-3.30)	3.17	B
18		12	-	-	4.18	2.82	-	-	7.00(2.8-9.1)	2.15(0.90-3.52)	3.26	A
22		12	-	-	4.63	2.57	-	-	7.20(2.8-9.4)	2.20(0.90-3.52)	3.27	A
24		12	-	-	4.82	2.48	-	-	7.30(2.8-9.5)	2.15(0.90-3.52)	3.40	A
14		14	-	-	3.55	3.55	-	-	7.10(2.8-9.0)	2.20(0.90-3.40)	3.23	A
18		14	-	-	4.07	3.13	-	-	7.20(2.8-9.3)	2.20(0.90-3.52)	3.27	A
22		14	-	-	4.47	2.83	-	-	7.30(2.8-9.6)	2.20(0.90-3.52)	3.32	A
24		14	-	-	4.66	2.74	-	-	7.40(3.4-9.7)	2.20(1.10-3.52)	3.36	A
7		7	7	-	2.30	2.30	2.30	-	6.90(1.8-7.5)	2.20(0.60-2.44)	3.14	B
9		7	7	-	2.70	2.30	2.30	-	7.30(2.8-7.7)	2.35(0.90-2.55)	3.11	B
12		7	7	-	3.02	1.99	1.99	-	7.00(2.8-8.2)	2.17(0.90-2.90)	3.23	A
14		7	7	-	3.27	1.96	1.96	-	7.20(1.8-8.9)	2.22(0.68-3.43)	3.24	A
18		7	7	-	4.08	1.81	1.81	-	7.70(2.8-10.0)	2.22(0.98-3.55)	3.47	A
22		7	7	-	4.49	1.66	1.66	-	7.80(2.8-10.1)	2.17(0.98-3.58)	3.59	A
24	7	7	-	4.57	1.61	1.61	-	7.80(2.8-10.1)	2.19(0.98-3.53)	3.56	A	
9	9	7	-	2.45	2.45	2.09	-	7.00(2.8-8.3)	2.17(0.90-2.90)	3.23	A	
12	9	7	-	2.78	2.34	2.08	-	7.20(1.6-8.9)	2.22(0.68-3.41)	3.24	A	
14	9	7	-	3.16	2.14	1.90	-	7.20(2.8-9.1)	2.22(0.98-3.56)	3.24	A	
18	9	7	-	3.96	1.98	1.76	-	7.70(2.8-9.9)	2.22(0.98-3.56)	3.47	A	
22	9	7	-	4.37	1.82	1.61	-	7.80(2.8-10.1)	2.22(0.98-3.58)	3.51	A	
24	9	7	-	4.46	1.77	1.57	-	7.80(2.8-10.1)	2.19(0.98-3.53)	3.56	A	
12	12	7	-	2.62	2.62	1.96	-	7.20(1.6-9.1)	2.22(0.68-3.54)	3.24	A	
14	12	7	-	3.04	2.43	1.83	-	7.30(2.8-9.2)	2.22(0.98-3.56)	3.29	A	
18	12	7	-	3.78	2.24	1.88	-	7.70(2.8-9.9)	2.22(0.98-3.54)	3.47	A	
22	12	7	-	4.19	2.06	1.55	-	7.80(2.8-10.1)	2.22(0.98-3.58)	3.51	A	
24	12	7	-	4.28	2.01	1.51	-	7.80(2.8-10.1)	2.19(0.98-3.56)	3.56	A	
14	14	7	-	2.81	2.81	1.68	-	7.30(2.8-9.3)	2.22(0.98-3.58)	3.29	A	
18	14	7	-	3.52	2.61	1.57	-	7.70(3.5-10.0)	2.22(1.17-3.58)	3.47	A	
22	14	7	-	3.93	2.42	1.45	-	7.80(3.5-10.1)	2.22(1.17-3.58)	3.51	A	
24	14	7	-	4.07	2.39	1.44	-	7.90(3.5-10.1)	2.20(1.17-3.58)	3.59	A	
18	18	7	-	3.19	1.42	-	-	7.80(3.5-10.1)	2.22(1.17-3.58)	3.51	A	
22	18	7	-	3.59	2.96	1.33	-	7.90(3.5-10.1)	2.22(1.17-3.58)	3.56	A	
24	18	7	-	3.68	2.92	1.30	-	7.90(4.7-10.1)	2.22(1.17-3.58)	3.56	A	
9	9	9	-	2.40	2.40	2.40	-	7.20(2.8-8.9)	2.22(0.98-3.42)	3.24	A	
12	9	9	-	2.68	2.26	2.26	-	7.20(2.8-9.1)	2.22(0.98-3.54)	3.24	A	
14	9	9	-	3.11	2.10	2.10	-	7.30(2.8-9.2)	2.22(0.98-3.57)	3.29	A	
18	9	9	-	3.85	1.93	1.93	-	7.70(2.8-9.9)	2.22(0.98-3.56)	3.47	A	
22	9	9	-	4.26	1.77	1.77	-	7.80(2.8-10.1)	2.22(0.98-3.58)	3.51	A	
24	9	9	-	4.35	1.73	1.73	-	7.80(2.8-10.1)	2.20(1.17-3.54)	3.55	A	
12	12	9	-	2.53	2.53	2.14	-	7.20(2.8-9.1)	2.22(0.98-3.54)	3.24	A	
14	12	9	-	2.95	2.36	1.99	-	7.30(2.8-9.2)	2.22(0.98-3.57)	3.29	A	
18	12	9	-	3.68	2.18	1.84	-	7.70(2.8-9.9)	2.22(0.98-3.56)	3.47	A	
22	12	9	-	4.09	2.01	1.70	-	7.80(2.8-10.1)	2.22(0.98-3.58)	3.51	A	
24	12	9	-	4.18	1.97	1.66	-	7.80(2.8-10.1)	2.19(0.98-3.56)	3.56	A	
14	14	9	-	2.73	2.73	1.84	-	7.30(3.5-9.3)	2.22(1.17-3.58)	3.29	A	
18	14	9	-	3.48	2.58	1.74	-	7.80(3.5-10.0)	2.22(1.17-3.58)	3.51	A	
22	14	9	-	3.84	2.36	1.60	-	7.80(3.5-10.1)	2.22(1.17-3.58)	3.51	A	
24	14	9	-	3.98	2.34	1.58	-	7.90(3.5-10.1)	2.22(1.17-3.56)	3.56	A	
18	18	9	-	3.12	3.12	1.56	-	7.80(4.7-10.1)	2.22(1.17-3.58)	3.51	A	
22	18	9	-	3.52	2.92	1.46	-	7.90(4.7-10.1)	2.22(1.17-3.58)	3.56	A	
12	12	12	-	2.43	2.43	2.43	-	7.30(2.8-9.2)	2.22(0.98-3.55)	3.29	A	
14	12	12	-	2.85	2.28	2.28	-	7.40(2.8-9.3)	2.22(0.98-3.58)	3.33	A	
18	12	12	-	3.57	2.12	2.12	-	7.80(3.5-10.0)	2.22(1.17-3.57)	3.51	A	
22	12	12	-	3.98	1.96	1.96	-	7.90(3.5-10.1)	2.22(1.17-3.58)	3.56	A	
24	12	12	-	4.07	1.92	1.92	-	7.90(3.5-10.1)	2.20(1.17-3.54)	3.59	A	
14	14	12	-	2.64	2.64	2.11	-	7.40(3.5-9.4)	2.22(1.17-3.58)	3.33	A	
18	14	12	-	3.34	2.48	1.98	-	7.80(3.5-10.1)	2.22(1.17-3.58)	3.51	A	
22	14	12	-	3.75	2.31	1.85	-	7.90(3.5-10.1)	2.22(1.17-3.58)	3.56	A	
24	14	12	-	3.05	3.05	1.81	-	7.90(4.7-10.1)	2.22(1.17-3.58)	3.56	A	
7	7	7	7	1.90	1.90	1.90	1.90	7.80(1.6-9.6)	2.20(0.68-3.41)	3.45	A	
9	7	7	7	2.07	1.84	1.84	1.84	7.80(1.6-9.8)	2.22(0.68-3.54)	3.42	A	
12	7	7	7	2.37	1.78	1.78	1.78	7.70(1.6-9.9)	2.22(0.68-3.44)	3.47	A	
14	7	7	7	2.75	1.66	1.66	1.66	7.70(2.8-9.9)	2.22(0.98-3.56)	3.47	A	
18	7	7	7	3.43	1.52	1.52	1.52	8.00(2.8-10.1)	2.20(0.98-3.55)	3.64	A	
22	7	7	7	3.80	1.40	1.40	1.40	8.00(2.8-10.1)	2.22(0.98-3.58)	3.60	A	
9	9	7	7	2.04	2.04	1.81	1.81	7.70(2.8-9.7)	2.22(0.98-3.42)	3.47	A	
12	9	7	7	2.30	1.94	1.73	1.73	7.70(2.8-9.9)	2.22(0.98-3.55)	3.47	A	
14	9	7	7	2.68	1.81	1.61	1.61	7.70(2.8-10.0)	2.22(0.98-3.57)	3.47	A	
18	9	7	7	3.35	1.67	1.49	1.49	8.00(3.5-10.1)	2.20(1.17-3.55)	3.64	A	
22	9	7	7	3.71	1.54	1.37	1.37	8.00(3.5-10.1)	2.22(1.17-3.58)	3.60	A	
12	12	7	7	2.20	2.20	1.65	1.65	7.70(2.8-10.0)	2.22(0.98-3.55)	3.47	A	
14	12	7	7	2.60	2.08	1.56	1.56	7.80(2.8-10.0)	2.22(0.98-3.57)	3.51	A	
18	12	7	7	3.22	1.91	1.43	1.43	8.00(3.5-10.1)	2.22(1.17-3.56)	3.64	A	
22	12	7	7	3.59	1.77	1.32	1.32	8.00(3.5-10.1)	2.22(1.17-3.58)	3.60	A	
14	14	7	7	2.50	2.50	1.50	1.50	8.00(3.5-10.1)	2.22(1.17-3.58)	3.60	A	
18	14	7	7	3.04	2.25	1.35	1.35	8.00(3.5-10.1)	2.22(1.17-3.58)	3.60	A	
9	9	9	7	1.98	1.98	1.98	1.76	7.70(2.8-9.9)	2.22(0.98-3.56)	3.47	A	
12	9	9	7	2.24	1.89	1.89	1.68	7.70(2.8-10.0)	2.22(0.98-3.56)	3.47	A	
14	9	9	7	2.64	1.78	1.78	1.59	7.80(3.5-10.1)	2.22(1.17-3.58)	3.51	A	
18	9	9	7	3.27	1.64	1.64	1.45	8.00(3.5-10.1)	2.22(1.17-3.56)	3.60	A	
22	9	9	7	3.64	1.51	1.51	1.34	8.00(3.5-10.1)	2.22(1.17-3.58)	3.60	A	
12	12	9	7	2.17	2.17	1.83	1.63	7.80(2.8-10.0)	2.22(0.98-3.56)	3.51	A	
14	12	9	7	2.54	2.03	1.71	1.52	7.80(3.5-10.1)	2.22(1.17-3.58)	3.51	A	
18	12	9	7	3.15	1.87	1.58	1.40	8.00(3.5-10.1)	2.22(1.17-3.56)	3.60	A	
14	14	9	7	2.41	2							

AOY30LMAW4	Indoor model for each room				HEATING OPERATION					COP	Heating class	
					HEATING OPERATION				Total			Power Input
					Room 1	Room 2	Room 3	Room 4				
1 Room	7	-	-	-	2.70	-	-	-	2.70(1.5-3.3)	1.00(0.55-1.25)	2.70	E
	9	-	-	-	3.30	-	-	-	3.30(1.5-3.7)	1.22(0.55-1.41)	2.70	E
	12	-	-	-	3.80	-	-	-	3.80(1.5-4.5)	1.40(0.55-1.80)	2.71	E
	14	-	-	-	4.80	-	-	-	4.80(1.7-5.8)	1.48(0.58-1.90)	3.24	C
	18	-	-	-	6.00	-	-	-	6.00(3.2-7.1)	1.90(0.90-2.46)	3.16	D
	22	-	-	-	7.50	-	-	-	7.50(3.2-8.8)	2.29(0.90-2.92)	3.28	C
	24	-	-	-	8.20	-	-	-	8.20(3.2-9.0)	2.78(0.90-3.33)	2.95	D
	7	7	-	-	2.70	2.70	-	-	5.40(1.7-5.9)	1.58(0.55-1.80)	3.42	B
	9	7	-	-	3.30	2.70	-	-	6.00(1.7-7.2)	1.76(0.55-2.50)	3.41	B
	12	7	-	-	3.80	2.70	-	-	6.50(1.7-7.2)	2.20(0.55-2.45)	2.95	D
14	7	-	-	4.80	2.70	-	-	7.50(3.3-8.7)	2.25(0.90-2.88)	3.33	C	
18	7	-	-	6.00	2.70	-	-	8.70(3.3-9.4)	2.67(0.90-3.00)	3.26	C	
22	7	-	-	6.84	2.46	-	-	9.30(3.3-10.5)	2.67(0.90-3.34)	3.48	B	
24	7	-	-	7.15	2.35	-	-	9.50(3.3-10.7)	2.70(0.90-3.50)	3.52	B	
9	9	-	-	3.30	3.30	-	-	6.60(3.3-7.4)	2.02(0.90-2.50)	3.27	C	
12	9	-	-	3.80	3.30	-	-	7.10(1.7-8.3)	2.35(0.55-3.08)	3.02	D	
14	9	-	-	4.80	3.30	-	-	8.10(3.3-9.3)	2.67(0.90-3.30)	3.03	D	
18	9	-	-	5.87	3.23	-	-	9.10(3.3-10.1)	2.67(0.90-3.40)	3.41	B	
22	9	-	-	6.53	2.87	-	-	9.40(3.3-10.7)	2.67(0.90-3.50)	3.52	B	
24	9	-	-	6.77	2.73	-	-	9.50(3.3-11.0)	2.67(0.90-3.50)	3.56	B	
12	12	-	-	3.80	3.80	-	-	7.60(3.3-8.8)	2.65(0.90-3.30)	2.87	D	
14	12	-	-	4.80	3.80	-	-	8.60(3.3-9.8)	3.06(0.90-3.50)	2.81	D	
18	12	-	-	5.69	3.61	-	-	9.30(3.3-10.3)	2.90(0.90-3.50)	3.21	C	
22	12	-	-	6.37	3.23	-	-	9.60(3.3-11.0)	2.78(0.90-3.50)	3.45	A	
24	12	-	-	6.56	3.04	-	-	9.60(3.3-11.0)	2.68(0.90-3.50)	3.58	B	
14	14	-	-	4.70	4.70	-	-	9.40(3.3-10.3)	2.93(0.90-3.50)	3.21	C	
18	14	-	-	5.33	4.27	-	-	9.60(3.3-11.1)	2.77(0.90-3.50)	3.47	B	
22	14	-	-	5.85	3.75	-	-	9.60(3.3-11.5)	2.65(0.90-3.50)	3.62	A	
24	14	-	-	6.06	3.54	-	-	9.60(4.3-11.5)	2.65(1.02-3.50)	3.62	A	
7	7	7	-	2.70	2.70	2.70	-	8.10(1.8-8.8)	2.30(0.55-2.65)	3.52	B	
9	7	7	-	3.30	2.70	2.70	-	8.70(3.3-9.3)	2.60(0.90-2.85)	3.35	C	
12	7	7	-	3.80	2.70	2.70	-	9.20(3.3-9.7)	2.83(0.90-3.10)	3.25	C	
14	7	7	-	4.15	2.42	2.42	-	9.00(1.8-10.1)	2.66(0.58-3.53)	3.38	C	
18	7	7	-	4.86	2.27	2.27	-	9.40(3.3-11.2)	2.46(0.87-3.52)	3.82	A	
22	7	7	-	5.28	2.11	2.11	-	9.50(3.3-11.6)	2.43(0.87-3.52)	3.91	A	
24	7	7	-	5.44	2.03	2.03	-	9.50(3.3-11.5)	2.47(0.87-3.52)	3.85	A	
9	9	7	-	3.30	3.30	2.70	-	9.30(3.3-9.7)	2.80(0.90-3.10)	3.32	C	
12	9	7	-	3.56	2.94	2.49	-	9.00(1.8-10.0)	2.69(0.58-3.51)	3.35	C	
14	9	7	-	4.00	2.75	2.33	-	9.10(3.3-10.2)	2.64(0.87-3.50)	3.45	B	
18	9	7	-	4.66	2.56	2.17	-	9.40(3.3-11.3)	2.45(0.87-3.50)	3.84	A	
22	9	7	-	5.13	2.42	2.05	-	9.60(3.3-11.7)	2.41(0.87-3.51)	3.98	A	
24	9	7	-	5.29	2.33	1.98	-	9.60(3.3-11.5)	2.46(0.87-3.51)	3.90	A	
12	12	7	-	3.33	3.33	2.33	-	9.00(1.8-10.1)	2.66(0.58-3.48)	3.38	C	
14	12	7	-	3.80	3.17	2.22	-	9.10(3.3-10.3)	2.62(0.87-3.48)	3.51	A	
18	12	7	-	4.45	2.97	2.08	-	9.50(3.3-11.4)	2.44(0.87-3.47)	3.89	A	
22	12	7	-	4.87	2.78	1.95	-	9.60(3.3-11.7)	2.40(0.87-3.49)	4.00	A	
24	12	7	-	5.03	2.69	1.88	-	9.60(3.3-11.7)	2.45(0.87-3.56)	3.92	A	
14	14	7	-	3.60	3.60	2.10	-	9.30(3.3-10.6)	2.59(0.87-3.48)	3.59	B	
18	14	7	-	4.19	3.35	1.96	-	9.50(3.7-11.5)	2.42(0.97-3.52)	3.93	A	
22	14	7	-	4.60	3.16	1.84	-	9.60(3.7-11.8)	2.40(0.97-3.52)	4.00	A	
24	14	7	-	4.77	3.05	1.78	-	9.60(3.3-11.7)	2.45(0.87-3.56)	3.92	A	
18	18	7	-	3.89	3.89	1.82	-	9.60(3.7-12.0)	2.40(0.97-3.52)	4.00	A	
22	18	7	-	4.25	3.65	1.70	-	9.60(3.7-12.0)	2.40(0.97-3.52)	4.00	A	
24	18	7	-	4.42	3.53	1.65	-	9.60(4.3-12.0)	2.40(1.12-3.52)	4.00	A	
9	9	9	-	3.00	3.00	3.00	-	9.00(3.3-10.0)	2.69(0.87-3.51)	3.35	C	
12	9	9	-	3.39	2.80	2.80	-	9.00(3.3-10.1)	2.67(0.87-3.48)	3.37	C	
14	9	9	-	3.87	2.66	2.66	-	9.20(3.3-10.3)	2.63(0.87-3.48)	3.50	B	
18	9	9	-	4.52	2.49	2.49	-	9.50(3.7-11.4)	2.44(0.97-3.48)	3.89	A	
22	9	9	-	4.94	2.33	2.33	-	9.60(3.7-11.7)	2.41(0.97-3.50)	3.98	A	
24	9	9	-	5.11	2.25	2.25	-	9.60(3.7-11.7)	2.45(0.97-3.57)	3.92	A	
12	12	9	-	3.22	3.22	2.65	-	9.10(3.3-10.3)	2.65(0.87-3.52)	3.43	B	
14	12	9	-	3.69	3.07	2.53	-	9.30(3.3-10.5)	2.61(0.87-3.52)	3.56	B	
18	12	9	-	4.29	2.86	2.36	-	9.50(3.7-11.4)	2.43(0.97-3.47)	3.91	A	
22	12	9	-	4.70	2.69	2.22	-	9.60(3.7-11.7)	2.40(0.97-3.48)	4.00	A	
24	12	9	-	4.86	2.59	2.14	-	9.60(3.7-11.8)	2.44(0.97-3.55)	3.93	A	
14	14	9	-	3.46	3.46	2.38	-	9.30(3.7-10.7)	2.58(0.97-3.46)	3.60	B	
18	14	9	-	4.04	3.23	2.22	-	9.50(3.7-11.6)	2.41(0.97-3.51)	3.94	A	
22	14	9	-	4.45	3.05	2.10	-	9.60(3.7-11.9)	2.40(0.97-3.51)	4.00	A	
24	14	9	-	4.62	2.95	2.03	-	9.60(4.3-11.9)	2.42(1.12-3.57)	3.97	A	
18	18	9	-	3.76	3.76	2.07	-	9.60(4.3-12.0)	2.40(1.12-3.52)	4.00	A	
22	18	9	-	4.12	3.53	1.94	-	9.60(4.3-12.0)	2.40(1.12-3.52)	4.00	A	
12	12	12	-	3.07	3.07	3.07	-	9.20(3.3-10.3)	2.63(0.87-3.49)	3.50	B	
14	12	12	-	3.49	2.91	2.91	-	9.30(3.3-10.6)	2.59(0.87-3.49)	3.59	B	
18	12	12	-	4.07	2.71	2.71	-	9.40(3.7-11.6)	2.42(0.97-3.52)	3.93	A	
22	12	12	-	4.48	2.56	2.56	-	9.60(3.7-11.9)	2.40(0.97-3.52)	4.00	A	
24	12	12	-	4.65	2.48	2.48	-	9.60(3.7-11.8)	2.43(0.97-3.54)	3.95	A	
14	14	12	-	3.32	3.32	2.76	-	9.40(3.7-10.8)	2.40(0.97-3.50)	3.92	A	
18	14	12	-	3.85	3.08	2.57	-	9.50(3.7-11.6)	2.40(0.97-3.49)	3.96	A	
22	14	12	-	4.25	2.92	2.43	-	9.60(3.7-11.9)	2.40(0.97-3.49)	4.00	A	
18	18	12	-	3.60	3.60	2.40	-	9.60(4.3-12.0)	2.40(1.12-3.52)	4.00	A	
7	7	7	7	2.35	2.35	2.35	2.35	9.40(1.8-10.8)	2.58(0.58-3.47)	3.64	A	
9	7	7	7	2.68	2.27	2.27	2.27	9.50(1.8-10.9)	2.57(0.58-3.51)	3.71	A	
12	7	7	7	3.06	2.14	2.14	2.14	9.50(1.8-11.1)	2.56(0.58-3.55)	3.71	A	
14	7	7	7	3.49	2.04	2.04	2.04	9.60(3.3-11.3)	2.50(0.87-3.53)	3.79	A	
18	7	7	7	4.00	1.87	1.87	1.87	9.60(3.3-12.0)	2.40(0.87-3.56)	4.00	A	
22	7	7	7	4.37	1.75	1.75	1.75	9.60(3.3-12.0)	2.40(0.87-3.56)	4.00	A	
9	9	7	7	2.57	2.57	2.18	2.18	9.50(3.3-10.9)	2.56(0.87-3.44)	3.71	A	
12	9	7	7	2.95	2.43	2.06	2.06	9.50(3.3-11.1)	2.55(0.87-3.54)	3.73	A	
14	9	7	7	3.36	2.31	1.96	1.96	9.60(3.3-11.4)	2.53(0.87-3.54)	3.79	A	
18	9	7	7	3.87	2.13	1.80	1.80	9.60(3.7-12.0)	2.40(0.97-3.55)	4.00	A	
22	9	7	7	4.23	1.99	1.69	1.69	9.60(3.7-12.0)	2.40(0.97-3.55)	4.00	A	
12	12	7	7	2.82	2.82	1.98	1.98	9.60(3.3-11.3)	2.54(0.87-3.57)	3.78	A	
14	12	7	7	3.20	2.67	1.87	1.87	9.60(3.3-11.5)	2.51(0.87-3.58)	3.82	A	
18	12	7	7	3.69	2.46	1.72	1.72	9.60(3.7-12.0)	2.40(0.97-3.58)	4.00	A	
22	12	7	7	4.05	2.31	1.62	1.62	9.60(3.7-12.0)	2.40(0.97-3.58)	4.00	A	
14	14	7	7	3.03	3.03	1.77	1.77	9.60(3.7-11.8)	2.49(0.97-3.58)	3.86	A	
18	14	7	7	3.51	2.81	1.64	1.64	9.60(3.7-12.0)	2.40(0.97-3.56)	4.00	A	
9	9	9	7	2.47	2.47	2.09	2.09	9.50(3.3-11.2)	2.55(0.87-3.54)	3.73	A	
12	9	9	7	2.87	2.36	2.36	2.01	9.60(3.3-11.3)	2.54(0.87-3.58)	3.78	A	
14	9	9	7	3.25	2.23	2.23	1.89	9.60(3.7-11.5)	2.52(0.97-3.58)	3.81	A	
18	9	9	7	3.74	2.06	2.06	1.75	9.60(3.7-12.0)	2.40(0.97-3.58)	4.00	A	
22	9	9	7	4.10	1.93	1.93	1.64	9.60(3.7-12.0)	2.40(0.97-3.58)	4.00	A	
12	12	9	7	2.72	2.72	2.25	1.91	9.60(3.3-11.4)	2.53(0.87-3.58)	3.79	A	
14	12	9	7	3.09	2.58	2.13	1.80	9.60(3.7-11.6)	2.50(0.97-3.58)	3.84	A	
18	12	9	7	3.58	2.39	1.97	1.67	9.60(3.7-12.0)	2.40(0.97-3.58)	4.00	A	
14	14	9	7	2.94	2.94	2.02	1.71					

# INVERTER

## Simultaneous Multi Twin / Triple



Can support various installation scenes from office to commercial space by same place multi connection of up to 3units.

Indoor units distributed layout according to the shape and number of people and lighting conditions of the room even on wide floors and atypical floors. Ideal comfortable air flow distribution can be realized.

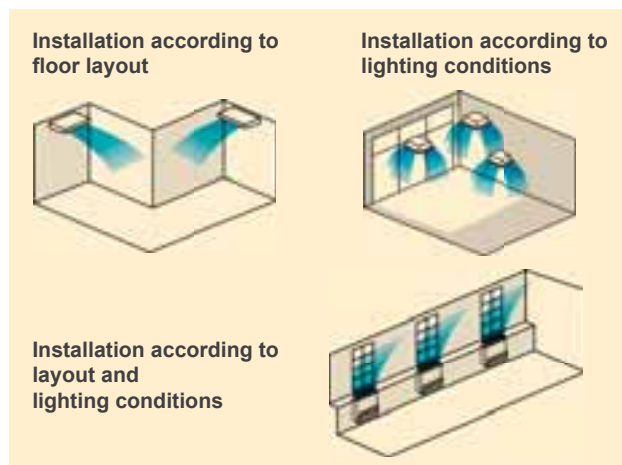

## Specifications

Model No.	Indoor unit		Compact Cassette		
			AUYF18LB	AUYF22LB	AUYF24LB
Power Source	V/∅/Hz		230/1/50	230/1/50	230/1/50
Air Flow (High)	Cooling H/M/L/Q	m <sup>3</sup> /h	680/580/490/410	1030/830/600/450	1030/830/600/450
Net Dimension H x W x D		mm	245x570x570	245x570x570	245x570x570
Weight		kg(lbs)	15 (33)	17 (36)	17 (36)
Grille			UTG-UFYB-W	UTG-UFYB-W	UTG-UFYB-W

Model No.	Indoor unit		Duct			Floor/Ceiling Universal		
			ARYF18LBU	ARYF22LBTU	ARYF24LBTU	ABYF18LB	ABYF22LBT	ABYF24LBT
Power Source	V/∅/Hz		230/1/50	230/1/50	230/1/50	230/1/50	230/1/50	
Air Flow (High)	Cooling H/M/L/Q	m <sup>3</sup> /h	830/670/580/480	1100/910/750/580	780/700/560/500	980/820/680/540	980/820/680/540	
Net Dimension H x W x D		mm	217 x 953 x 595	270 x 1135 x 700	199 x 990 x 655	199 x 990 x 655	199 x 990 x 655	
Weight		kg(lbs)	23 (51)	38 (84)	27 (60)	27 (60)	27 (60)	

Model No.	Outdoor unit		AOYD36LATT	AOYD45LATT	AOYD54LATT
			Power Source	V/∅/Hz	400/3/50
Net Dimension H x W x D		mm	1290x900x330	1290x900x330	1290x900x330
Weight		kg(lbs)	107(236)	107(236)	107(236)
Piping Connections (Small / Large)		mm	9.52/15.88	9.52/15.88	9.52/15.88
Max Pipe Length (Chargeless)		mm	75	75	75
Height Difference		mm	30	30	30
Operation Range	Cooling	°CDB	-15~46	-15~46	-15~46
	Heating	°CDB	-15~24	-15~24	-15~24
Refrigerant			R410A	R410A	R410A
Separation tube			UTP-SX236A(Twin)	UTP-SX254A(Twin)	UTP-SX254A(Twin)/UTP-SX354A(Triple)

\*Different type and capacity indoor units can not be connected .



## Simultaneous control

Max 16 indoor units are simultaneously controlled with a wired remote controller.

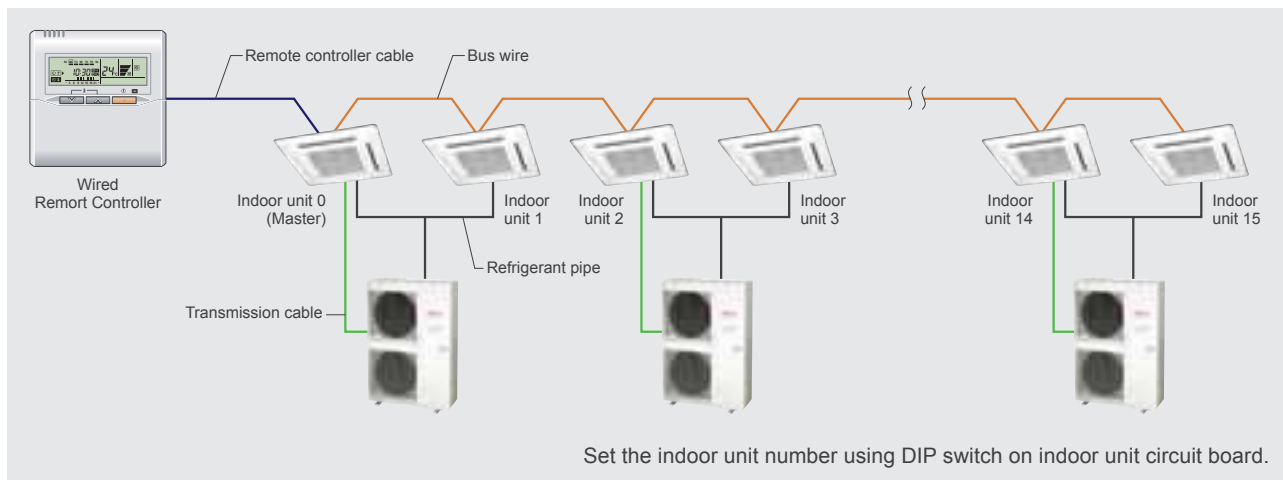

## Low ambient operation

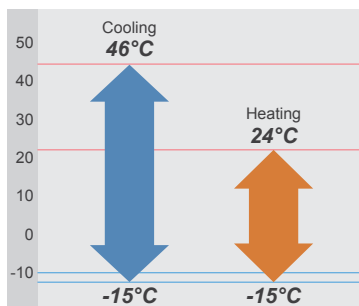

## External input

**Low noise mode:** Suppresses night time operating sound.  
**Peak cut function:** Suppresses maximum capacity and performs energy saving operation and can prevent breaker tripping.

## Piping connection

Four directions piping connection is possible. The perfect route can be selected according to the installation.

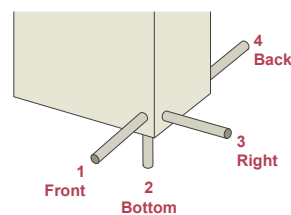

## Dimensions

Models: AOYD36LATT / AOYD45LATT / AOYD54LATT

(Unit : mm)

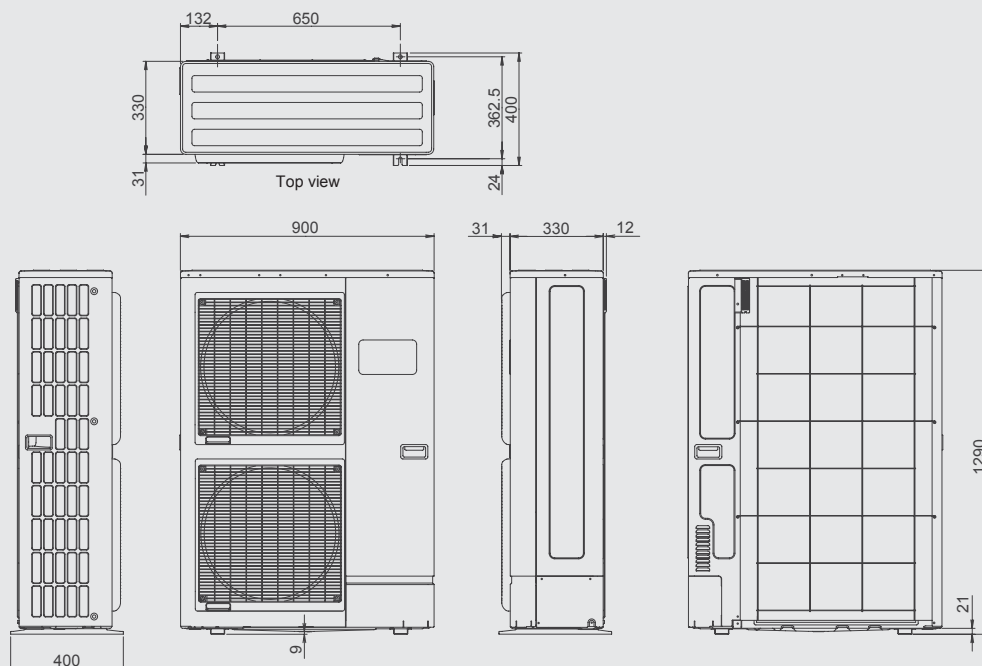



# Big Multi Type Systems

## Simultaneous Operation

### Features of System Operations

- Simultaneous Operating System suitable for large spaces such as offices, lobbies and waiting rooms of high-rise buildings.
- One controller can simultaneously control cooling or heating by 2~4 indoor units.

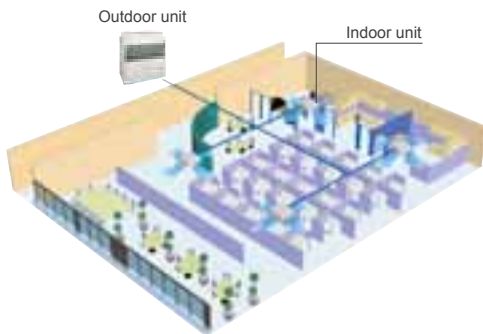

### Indoor Unit Lineup

CAPACITY (BTU)	CASSETTE (COMPACT)	CASSETTE	DUCT	FLOOR/CEILING UNIVERSAL	CEILING (LARGE)
	45,000				
36,000		•	•		•
30,000		•	•		•
(25,000)		•	•		
24,000				•	
18,000	•			•	

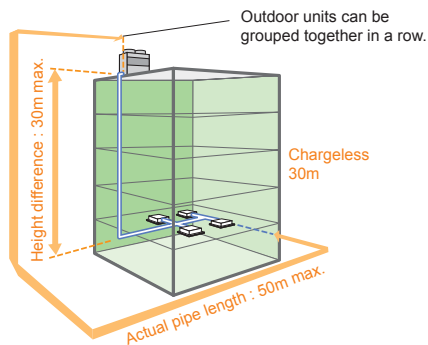

## Individual Operation

### Features of System Operations

- Individual Operating System is suitable for large spaces such as hotels, commercial spaces, offices and restaurants.
- The system can cool and heat individually, because it has two refrigeration cycles.

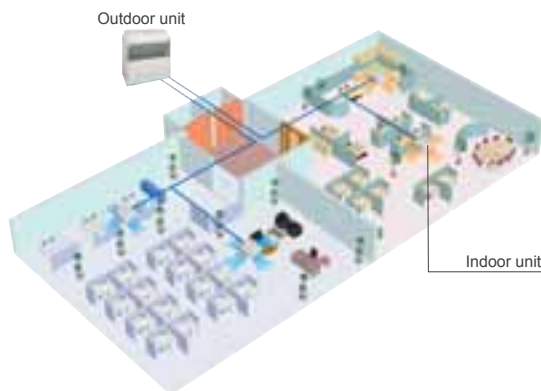

### Indoor Unit Lineup

CAPACITY (BTU)	CASSETTE (COMPACT)	CASSETTE	DUCT	FLOOR/CEILING UNIVERSAL	CEILING (LARGE)
	45,000				
36,000		•	•		•
30,000		•	•		
(25,000)					
24,000				•	
18,000	•			•	

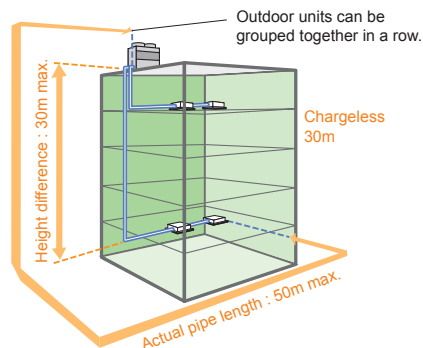

## Specifications

Model name		ABYA18TATA	ABYA24TATA	ABYA30TATA	ABYA36TATA	ABYA45TATA	ARXA25TATA	ARXA30TATA	ARXA36TATA	ARXA45TATA	
Power Source	V/ø/Hz	220-240/1/50	220-240/1/50	220-240/1/50	220-240/1/50	220-240/1/50	220-240/1/50	220-240/1/50	220-240/1/50	220-240/1/50	
	Capacity	kW	5.20~5.30	6.50~6.60	8.60~8.80	10.30~10.50	12.40~12.70	6.95~7.05	8.60~8.80	10.30~10.50	12.40~12.70
Capacity	Heating	kW	5.50~5.60	7.60~7.70	8.80~9.10	10.50~10.70	13.40~13.70	7.60~7.85	8.80~9.10	10.50~10.70	13.40~13.70
	Cooling	BTU/h	17,800~18,100	22,200~22,500	29,400~30,000	35,200~36,000	42,500~43,500	23,700~24,100	29,400~30,000	35,200~36,000	42,500~43,500
Moisture Removal	Heating	BTU/h	18,800~19,100	25,900~26,300	30,000~31,000	36,000~36,500	46,000~47,000	25,900~26,800	30,000~31,000	36,000~36,500	46,000~47,000
	Moisture Removal	l/h	2.20	3.40	4.00	4.00	5.50	2.50	3.00	4.00	5.50
Airflow Rate	High	m <sup>3</sup> /h	800	900	1,270	1,660	1,850	1,600	1,650	2,000	2,200
	Med	m <sup>3</sup> /h	680	780	1,120	1,500	1,660	1,450	1,550	1,800	2,000
	Low	m <sup>3</sup> /h	560	660	860	1,270	1,430	1,280	1,350	1,600	1,800
Fan Motor Output	W	30	40	160	160	160	70	275	275	275	
Fan Type x Q'ty		Sirocco x 2	Sirocco x 2	Sirocco x 4	Sirocco x 4	Sirocco x 4	Sirocco x 2	Sirocco x 2	Sirocco x 2	Sirocco x 2	
Net Dimension H x W x D	mm	199x990x655	199x990x655	240x1,660x700	240x1,660x700	240x1,660x700	270x1,210x700	270x1,210x700	270x1,210x700	270x1,210x700	
	kg	28	30	48	48	48	43	43	45	45	
Connection Method		Flare	Flare	Flare	Flare	Flare	Flare	Flare	Flare	Flare	
Connection Pipe Size (Small/Large)	mm	9.53/15.88	9.53/15.88	9.53/15.88	9.53/19.05	9.53/19.05	9.53/15.88	9.53/15.88	9.53/19.05	9.53/19.05	
Operation Range	Cooling	°C	18~30	18~30	18~30	18~30	18~30	18~30	18~30	18~30	
	Heating	°C	16~30	16~30	16~30	16~30	16~30	16~30	16~30	16~30	
Grille		-	-	-	-	-	-	-	-	-	

**Refrigerant System (Simultaneous Operation)**

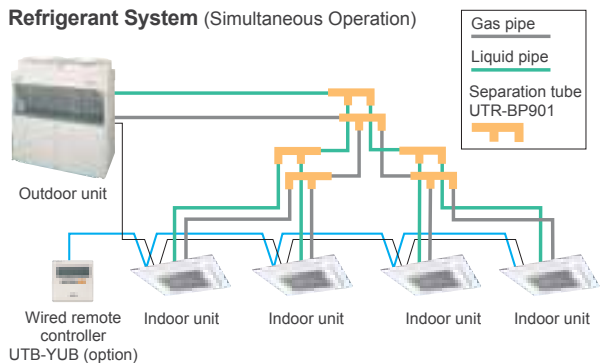

**Refrigerant System (Individual Operation)**

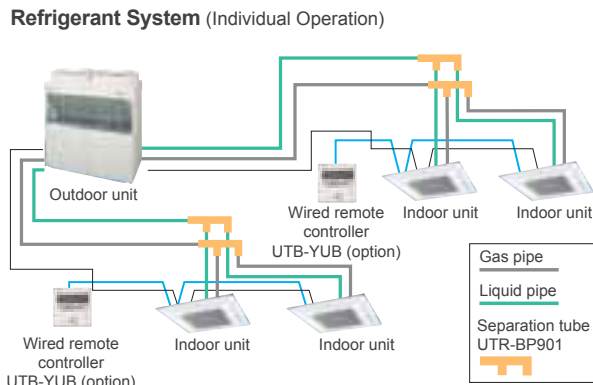

**Dimensions** Models: AJYA90EATA / AJYA90TATA / AJYA90EATB / AJYA90TATB

(Unit : mm)

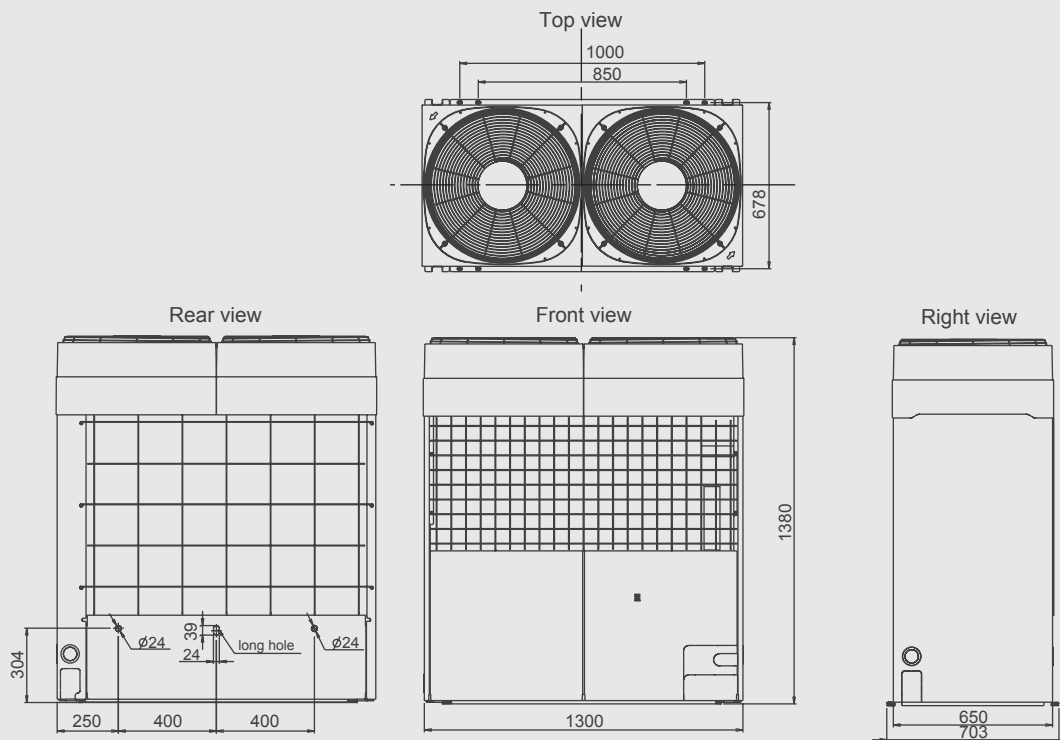

AUXA18TATA	AUYA25TATA	AUYA30TATA	AUYA36TATA	AUYA45TATA
220-240/1/50	220-240/1/50	220-240/1/50	220-240/1/50	220-240/1/50
4.85~5.00	6.95~7.05	8.60~8.80	10.30~10.50	12.40~12.70
5.30~5.45	7.60~7.85	8.80~9.10	10.50~10.70	13.40~13.70
19,000~19,900	23,700~24,100	29,400~30,000	35,200~36,000	42,300~43,400
21,000~21,600	25,900~26,800	30,000~31,100	35,800~36,500	45,800~46,800
2.10	2.50	3.00	4.00	5.00
650	1,170	1,270	1,500	1,650
550	970	1,070	1,300	1,450
490	770	880	1,100	1,200
14	90	90	90	90
Turbo x 1	Turbo x 1	Turbo x 1	Turbo x 1	Turbo x 1
235x580x580(+70)	296x830x830	296x830x830	296x830x830	296x830x830
18	38	38	40	40
Flare	Flare	Flare	Flare	Flare
9.53/15.88	9.53/15.88	9.53/15.88	9.53/19.05	9.53/19.05
18~30	18~30	18~30	18~30	18~30
16~30	16~30	16~30	16~30	16~30
UTG-UDYD-W	-	-	-	-

Model name				Individual Operation		Simultaneous Operation	
				AJYA90EATA	AJYA90TATA	AJYA90EATB	AJYA90TATB
Power Source	V/ø/Hz	380-415/W4/50	380-415/W4/50	380-415/W4/50	380-415/W4/50		
Total Capacity	Cooling	kW	25.40	25.40	25.40	25.40	
	Heating	kW	-	28.60	-	28.60	
Total Input Watts	Cooling	kW	9.40	9.40	9.40	9.40	
	Heating	kW	-	10.00	-	10.00	
Total Ampacity	Cooling	A	16.20	16.20	16.20	16.20	
	Heating	A	-	17.00	-	17.00	
Starting Current	A	63.00	63.00	63.00	63.00		
EER	Cooling	W/W	2.70	2.70	2.70	2.70	
	Heating	W/W	-	2.86	-	2.86	
COP	High	r.p.m	730	730	730	730	
	Low	r.p.m	360	360	360	360	
Airflow Rate	High	m³/h	9,800	9,800	9,800	9,800	
	Fan Type x Q'ty		Propeller x 2	Propeller x 2	Propeller x 2	Propeller x 2	
Fan Motor Output	W	150x2	150x2	150x2	150x2		
Net Dimension H x W x D	mm	1,380x1,300x650	1,380x1,300x650	1,380x1,300x650	1,380x1,300x650		
Weight	kg	243	245	243	245		
Noise Level(Sound Pressure)		db(A)	57	57	57	57	
	Indoor Air Temp.	Cooling	DB/WB	27/19	27/19	27/19	27/19
Condition	Heating	(°C)	20/(15)	20/(15)	20/(15)	20/(15)	
	Outdoor Air Temp.	Cooling	DB/WB	35/24	35/24	35/24	35/24
Refrigerant	Heating	(°C)	7/6	7/6	7/6	7/6	
	Type		R407C	R407C	R407C	R407C	
Pipe	Charge	kg	3.1x2	3.1x2	6.00	6.00	
	Size	Liquid/Gas	mm	9.53/19.05	9.53/19.05	12.70/28.58	12.70/28.58
Pipe	Max Length	m	50	50	50	50	
	Max Height	m	30	30	30	30	
	Max Chargeless Length	m	30	30	30	30	
Operation(Outdoor)	Cooling	°C	0~52	0~52	0~52	0~52	
	Heating	°C	-10~21	-10~21	-10~21	-10~21	

# VRF



**AIRSTAGE** creates a comfortable space with a wide range of series variations.

Comfort is required of spaces where people gather. VRF is a large multi system that effectively air conditions a wide range of spaces from large buildings to personal residences. This system makes a variety of spaces comfortable utilizing high environmental performance and powerful but pleasant operation.

## Contents

- 076 **AIRSTAGE J** Heat pump type
- 084 **AIRSTAGE S** Heat recovery type
- 088 **AIRSTAGE V** Heat pump type
- 102 **AIRSTAGE V-II** Heat pump type
- 120 **Control Systems**



AIRSTAGE J



AIRSTAGE S



AIRSTAGE V

2008 New Model  
AIRSTAGE V-II series





THE POSSIBILITIES ARE INFINITE **FUJITSU**



**AIRSTAGE™**



**Variable Refrigerant Flow system For Home & Buildings**

FUJITSU GENERAL LIMITED

Compact VRF System for use in apartments, homes, shops, offices and a broad range of other applications



Heat pump  
AJYA54LCLR

## Economy & Comfort

### Powerful operation with low electricity consumption

Excellent EER/COP are attainable as shown in the table below.

Cooling EER <b>3.20*</b>	Heating COP <b>3.40*</b>
-----------------------------	-----------------------------

\*"EER/COP" is the coefficient of performance (=capacity (kW) ÷ input power (kW)).  
\*EER/COP values are based on our own testing method.

Uses a high-performance DC inverter scroll compressor with variable capacity according to the load during cooling and heating.



### Low noise design

Newly designed larger fan and double casing bell mouth construction reduce noise emissions.

**Large fan**  
Low speed design suppresses noise by using a larger fan.



**Double casing bell mouth**  
Double casing bell mouth helps to reduce noise.

### Wide operating range

Outdoor unit operates over an ambient temperature range of -5°C to 43°C for cooling and -20°C to 21°C for heating.

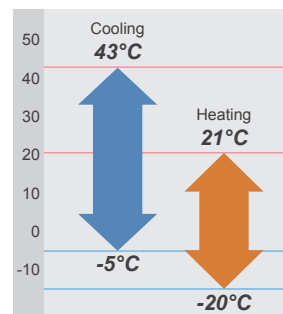

# Design Versatility

## Compact design

Small, compact casing can be easily concealed. The low overall height allows the unit to be neatly positioned beneath a window.

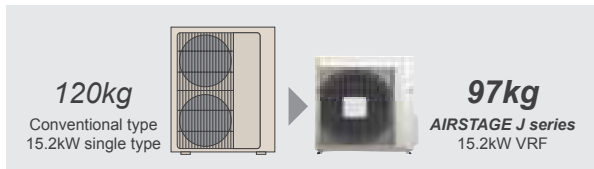
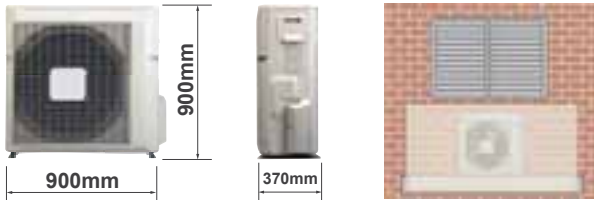

## Long piping length

The maximum piping length is 70m, and can cope with a wide range of applications from homes to offices.

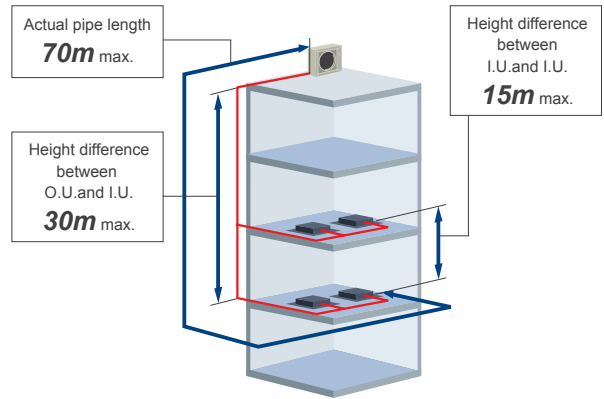

## High capacity connection

- Up to 8 indoor units can be connected to 1 outdoor unit. Furthermore, the indoor unit connection capacity can be up to 150% of the outdoor unit rating. This increases design flexibility.
- All indoor units are supplied with a Wireless Remote Controller.

Max. 8 indoor units connectable

Indoor unit connectable capacity 150%

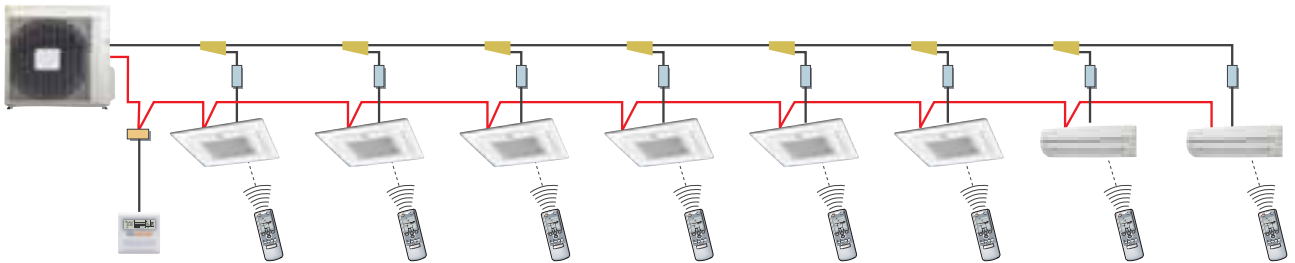

## System that allows individual air conditioning of multiple rooms

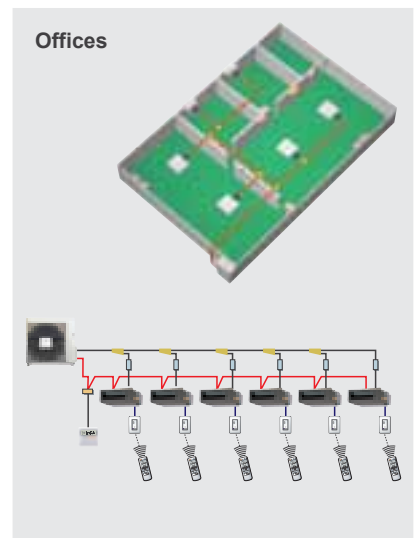
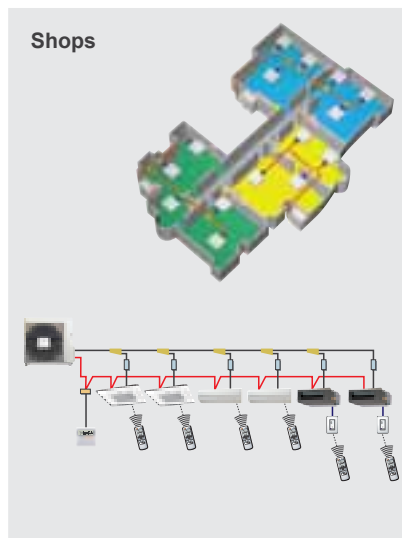
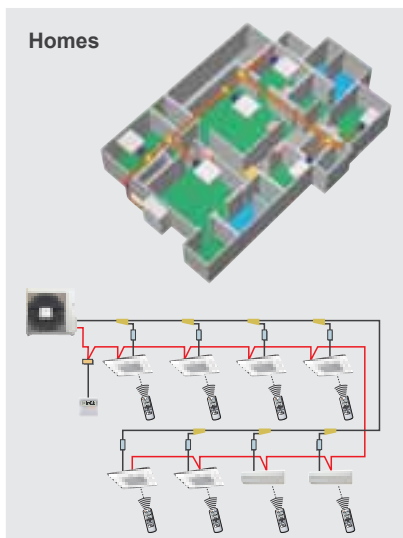

## Easy Installation

### Simple piping system

The wiring work is simple in the connection wiring system one by one. The dedicated communication line is unnecessary. The electrical work is simple because of single-phase power supply.

#### System diagram

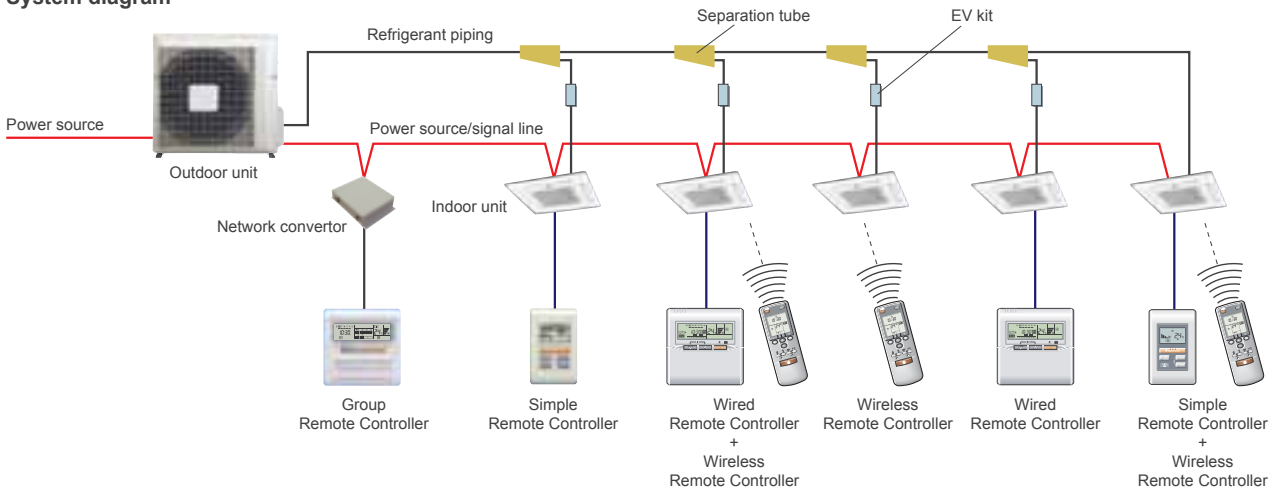

### Piping connection examples

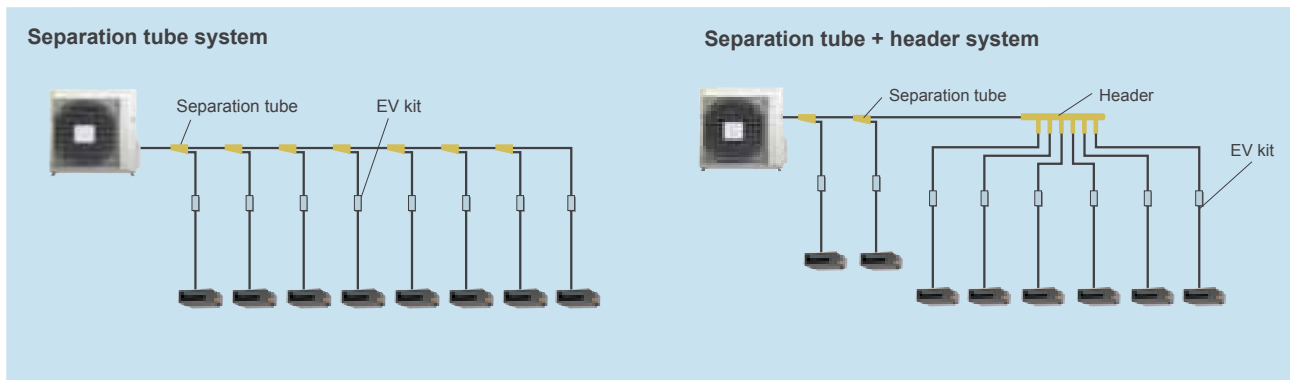

### Easy system address setting

During installation work, system addressing can be performed using the wireless remote controller, thus eliminating manual switch setting.

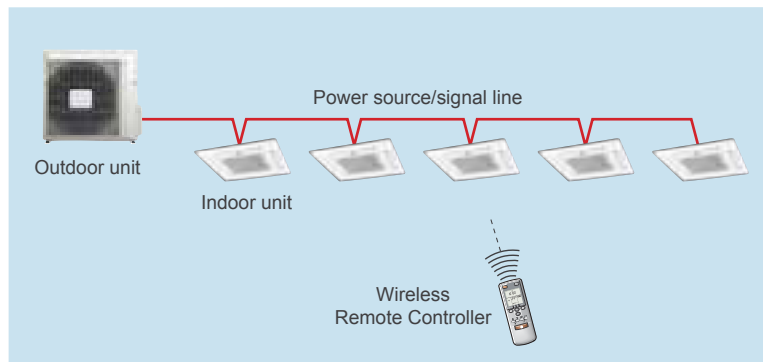



## Outdoor units specifications

### Dimensions Model: AJYA54LCLR

(Unit : mm)

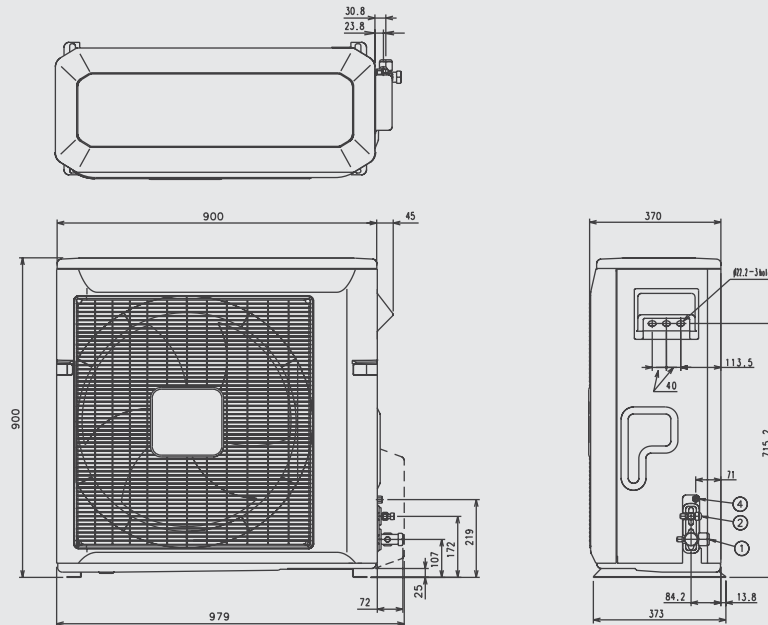

### Specifications

Rating Capacity range	HP	6
Model name	AJYA54LCLR	
Maximum Connectable Indoor Unit	8	
Indoor unit connectable capacity	Cooling	kW
	7.6 to 22.8	
Power source	Single-phase, 220-240V, 50Hz	
Capacity	Cooling	kW
	Heating	kW
	15.2	
	16.6	
Input power	Cooling	kW
	Heating	kW
	4.75	
	4.88	
EER	Cooling	W/W
	Heating	W/W
	3.2	
	3.4	
Air flow rate	High	m <sup>3</sup> /h
	5,250	
Sound pressure level	Normal operation mode	dB
	Silent operation mode	(A)
	56	
	51	
Compressor motor output	kW	
	3.0	
Heat exchanger fin	Plate fin coil	
Dimensions	Height	mm
	Width	mm
	Depth	mm
	900	
	900	
	370	
Weight	kg	
	97	
Refrigerant charge	kg	
	3.0	
Connection pipe diameter	Liquid	mm
	Gas	mm
	ø9.52	
	ø19.05	
Operation range	Cooling	°C
	Heating	°C
	-5 to 43	
	-20 to 21	

















Note: Specifications are based on the following conditions.

Cooling: Indoor temperature 27°CDB/19°CWB, and outdoor temperature 35°CDB/(24°CWB).













Heating: Indoor temperature 20°CDB/(15°CWB), and outdoor temperature 7°CDB/6°CWB.

Voltage: 230 [V]

## Indoor units lineup

Capacity range (kW)	2.15	2.80	3.60	4.00	5.30	5.70	
Model code	7	9	12	14	18	20	
<b>Compact Cassette</b>	 AU7UFAAR	 AU9UFAAR	 AU12UFAAR	 AU14UFAAR	 AU18UFAAR		
<b><small>Slim Type</small> Cassette</b>						 AU20UFARR	
<b>Compact Duct</b>	 ARXA07LALR	 ARXA09LALR	 ARXA12LALR	 ARXA14LALR	 ARXA18LALR		
<b>Duct</b>							
<b>Compact Wall Mounted</b>	 AS7UFADR	 AS9UFADR	 AS12UFADR	 AS14UFADR			
<b>Wall Mounted</b>					 AS18UFAJR		

6 Types, 28 Models, Capacity range from 2.15kW to 14.1kW

	6.00	6.90	7.05	8.80	10.5	12.7	14.1
	22	24	25	30	36	45	54
			 <p>Slim Type AU25UFARR</p>	 <p>Slim Type AU30UFARR</p>	 <p>AU36UFASR</p>	 <p>AU45UFASR</p>	 <p>AU54UFASR</p>
 <p>ARXA22LBLR</p>			 <p>AR25UFAAR ARXB25LATR</p>	 <p>AR30UFAAR ARXB30LATR</p>	 <p>AR36UFAAR</p>	 <p>AR45UFAAR</p>	
		 <p>AS24UFAJR</p>		 <p>AS30UFAJR</p>			

## Indoor units specifications

### Compact Cassette



Model name			AU7UFAAR	AU9UFAAR	AU12UFAAR	AU14UFAAR	AU18UFAAR
Power source			220-240V, 50Hz				
Capacity	Cooling	kW	2.15	2.80	3.60	4.00	5.00
	Heating		2.45	3.10	4.10	4.50	5.45
Input power		W	28			52	50
Airflow rate	High	m³/h	530			580	640
	Med		480			520	540
	Low		410			460	470
Sound pressure level	High	dB(A)	38			41	44
	Med		35			37	38
	Low		31			34	35
Dimensions (H x W x D)		Net	mm				
Weight		Net	kg				
Connection pipe diameter		Liquid (Flare)	mm				
		Gas (Flare)	ø9.52		ø12.70		ø15.88
		Drain	ø32 (I.D.); ø37 (O.D.)				

Note: Specifications are based on the following conditions.

Cooling: Indoor temperature 27°CDB/19°CWB, and outdoor temperature 35°CDB/(24°CWB).

Heating: Indoor temperature 20°CDB/15°CWB, and outdoor temperature 7°CDB/(6°CWB).

Voltage: 230[V]

### Cassette



Model name			AU20UFARR	AU25UFARR	AU30UFARR	AU36UFASR	AU45UFASR	AU54UFASR
Power source			220-240V, 50Hz					
Capacity	Cooling	kW	5.70	7.05	8.80	10.5	12.7	14.1
	Heating		5.80	7.85	9.10	10.7	13.7	15.8
Input power		W	117	129	142	175	190	219
Airflow rate	High	m³/h	1,030	1,170	1,270	1,500	1,650	1,780
	Med		850	970	1,070	1,300	1,450	1,550
	Low		680	770	880	1,100	1,200	1,300
Sound pressure level	High	dB(A)	42	42	45	48	49	52
	Med		38	40	42	44	47	49
	Low		37	39	39	41	43	45
Dimensions (H x W x D)		Net	mm			mm		
Weight		Net	kg			kg		
Connection pipe diameter		Liquid (Flare)	ø6.35		ø9.52			
		Gas (Flare)	ø15.88			ø19.05		
		Drain	ø32 (I.D.); ø37 (O.D.)					

Note: Specifications are based on the following conditions.

Cooling: Indoor temperature 27°CDB/19°CWB, and outdoor temperature 35°CDB/(24°CWB).

Heating: Indoor temperature 20°CDB/15°CWB, and outdoor temperature 7°CDB/(6°CWB).

Voltage: 230[V]

## Duct



Model name			ARXA07 LALR	ARXA09 LALR	ARXA12 LALR	ARXA14 LALR	ARXA18 LBLR	ARXA22 LBLR	ARXB25 LATR	ARXB30 LATR	AR25 UFAAR	AR30 UFAAR	AR36 UFAAR	AR45 UFAAR		
Power source			220-240V, 50Hz													
Capacity	Cooling	kW	2.15	2.80	3.50	4.00	5.30	6.00	7.05	8.80	7.05	8.80	10.5	12.7		
	Heating		2.45	3.10	4.10	4.80	5.60	6.30	7.85	9.10	7.85	9.10	10.7	13.7		
Input power			32		49		103		77		155		315			
Airflow rate	High	m <sup>3</sup> /h	420		620		950		890		1,340		2,200			
	Med		390		550		790		780		1,090		2,000			
	Low		360		470		620		670		970		1,800			
Static pressure range			0 to 40				0 to 80				30 to 160		30 to 180			
Sound pressure level	High	dB(A)	34		33		40		42		33		44			
	Med		32		29		35		38		29		42			
	Low		31		27		30		34		26		40			
Dimensions (H x W x D)			217 x 663 x 595		217 x 953 x 595				270 x 1,210 x 700							
Weight			18		25				43				45			
Connection pipe diameter	Liquid (Flare)	mm					ø6.35				ø9.52		ø6.35		ø9.52	
	Gas (Flare)		ø9.52		ø12.70						ø15.88					
	Drain		ø21.5 (I.D.); ø26 (O.D.)								ø35.7 (I.D.); ø38.1 (O.D.)					

Note: Specifications are based on the following conditions.

Cooling: Indoor temperature 27°CDB/19°CWB, and outdoor temperature 35°CDB/(24°CWB).

Heating: Indoor temperature 20°CDB/15°CWB, and outdoor temperature 7°CDB/(6°CWB).

Standard static pressure: 0Pa (AR7 to AR22), 100Pa (AR25 to AR45).

Voltage: 230[V]

## Wall Mounted



Model name			AS7UFADR	AS9UFADR	AS12UFADR	AS14UFADR	AS18UFAJR	AS24UFAJR	AS30UFAJR					
Power source			220-240V, 50Hz											
Capacity	Cooling	kW	2.15	2.80	3.50	3.80	5.40	6.90	8.00					
	Heating		2.45	3.10	4.10	4.50	5.60	7.80	8.80					
Input power			26		33		40		38		50		60	
Airflow rate	High	m <sup>3</sup> /h	410		500		540		840		950		1,050	
	Med		370		450		510		700		800		940	
	Low		350		410		480		600		670		780	
Sound pressure level	High	dB(A)	30		36		39		42		45		48	
	Med		27		33		37		39		41		45	
	Low		26		30		34		35		37		41	
Dimensions (H x W x D)			257 x 808 x 187				320 x 1,120 x 220							
Weight			8				16							
Connection pipe diameter	Liquid (Flare)	mm					ø6.35				ø9.52			
	Gas (Flare)		ø9.52		ø12.70						ø15.88			
	Drain		ø12 (I.D.); ø16.2 - 17 (O.D.)				ø12 (I.D.); ø16 (O.D.)							

Note: Specifications are based on the following conditions.

Cooling: Indoor temperature 27°CDB/19°CWB, and outdoor temperature 35°CDB/(24°CWB).

Heating: Indoor temperature 20°CDB/15°CWB, and outdoor temperature 7°CDB/(6°CWB).

Voltage: 230[V]

Maximum comfort from  
inbuilt flexibility



Heat recovery  
AO90MPCMF

## High Efficiency

### Operating system

Cooling and heating can be performed simultaneously within the same refrigerant circuit. Energy savings are made by transferring heat between the indoor units when in heat recovery operation.

Cooling EER <b>2.98*</b>	Heating COP <b>3.15*</b>	*EER/COP values are based on our own testing method.
-----------------------------	-----------------------------	--

### Smooth operation delivering high efficiencies

The configuration of 3 constant speed compressors with differing capacities and power accumulation technology ensure smooth step changes and highly efficient operation.

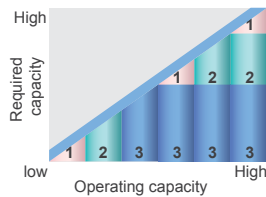

### Power accumulation technology

Flow rate to the indoor unit(s) is controlled through the use of 3 differently rated compressors operating in a sequential step arrangement. While power accumulation technology controls the circulating load of the refrigerant flow between those steps.

#### Diagram

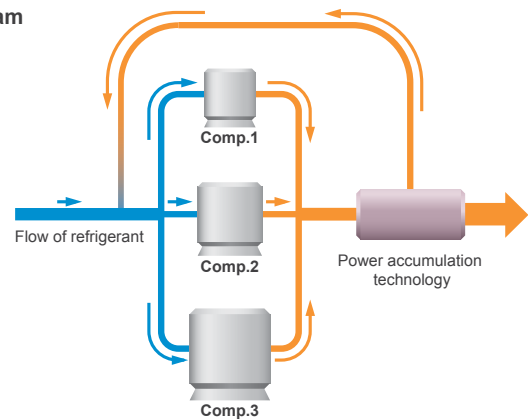

## Comfortable Operation

### Heat recovery operation

Heat recovery operation is a cooling/heating free operation system, cooling and heating can be performed simultaneously in the same refrigerant system according to user needs. At the moment, the Heat Recovery operation is an extremely superior type that provides a still greater energy saving effect by moving heat between indoor units that are performing the cooling and heating operations. This is by having the compressors act like a pump.

# Design Versatility

## Long piping system design

- Equivalent pipe length: 120m maximum.
- Total pipe length: 200m maximum.

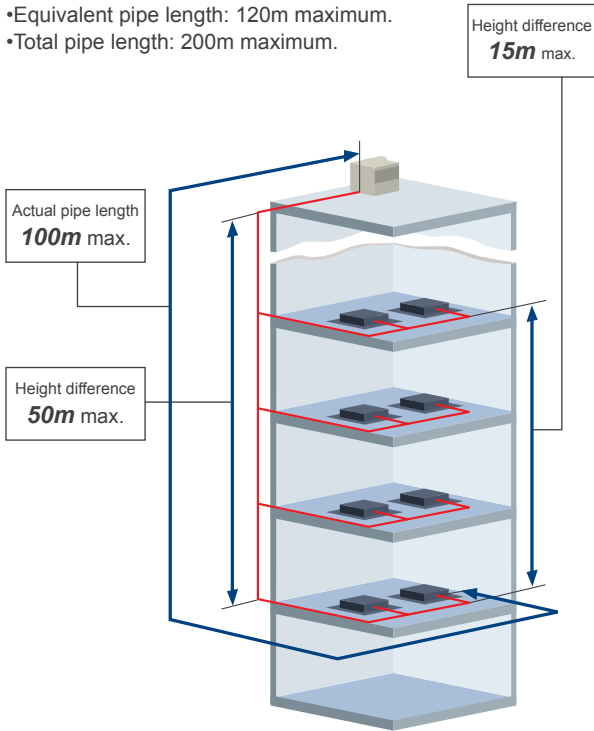

\*When outdoor unit is located above indoor unit. When outdoor unit is located below the indoor unit the height difference is 40m maximum.

## High capacity connection

One outdoor unit can control up to 16 indoor units (28kW) of different types and capacities.

Connectable capacity of indoor units for one outdoor unit  
**50 to 130%**

MAX Connectable indoor unit  
**16**

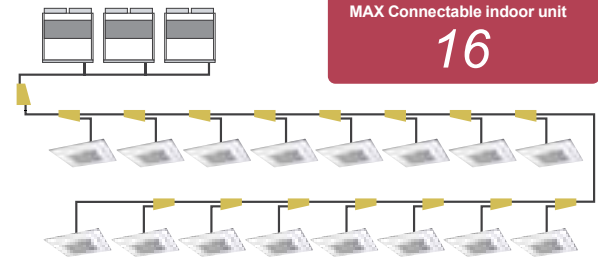

## Wide operating range

Outdoor unit operates over an outdoor temperature range of -5°C to 52°C for cooling and -15°C to 21°C for heating.

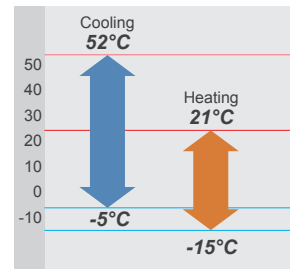

# High Reliability

## Recovery operation

**Outdoor Unit:** In the event of compressor failure an alarm is automatically triggered and the remaining compressor(s) will continue to operate, thereby ensuring continuous operation when possible.

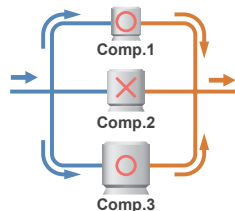

**Indoor Unit:** Each indoor unit operates independently from the others and is, therefore, not affected by a failure within any part of the network.

## Oil recovery operation

After a fixed period of time the oil recovery operation automatically returns accumulated oil found in the refrigerant circuit and indoor units.

# Improved Comfort

## Quiet operation

Operational noise has been reduced yet further through the application of a new dual casing bell-mouth and large fan. When set to silent operation, noise levels can be reduced by 5-6dB(A) compared to normal operation.

Normal operation mode  
**55dB(A)**

Silent operation mode  
**50dB(A)**

(380V)



## Easy Installation

### Space saving

Space saving by setting side by side without space in between.

Setting size **5.72** (Unit: m<sup>2</sup>)

#### Dimensions

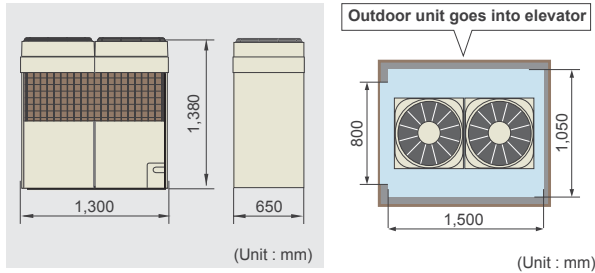

#### Installation space

##### For individually

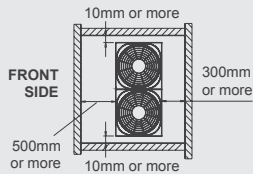

##### For continuous

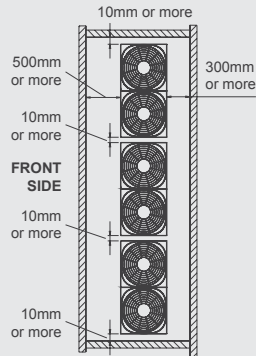

There is no height restriction for the side wall.  
The height(H) of front and rear wall should be less than 1,200mm.  
If the height of wall exceeds 1,200mm by h mm, add h mm to the service space width for L1 and L2.  
 $H \leq 1,200$  :  $L1 \geq 500$ ,  $L2 \geq 300$       $H > 1,200 + h$  :  $L1 > 500 + h$ ,  $L2 > 300 + h$

### Easy wiring

**Transmission line:**  
Non-polar 2-conductor transmission line prevents erroneous wiring.

**Power supply wiring:**  
Power supply for outdoor and indoor units is different.

- Outdoor unit  
3Ø 4W 380 - 415V 50Hz
- Indoor unit:  
1Ø 2W 220 - 240V 50Hz

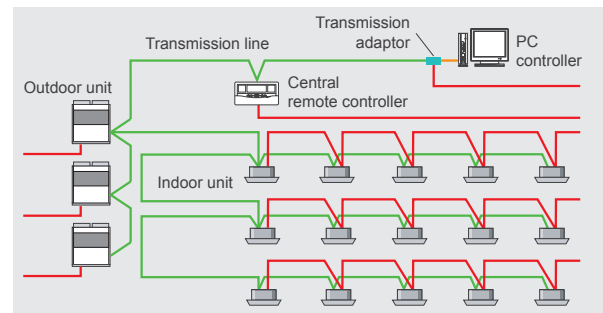
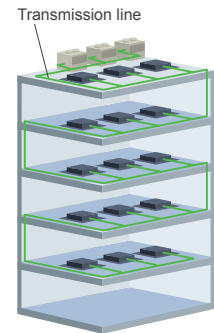

### Craning into place

The outdoor unit can be lifted by crane and set down on the building roof.

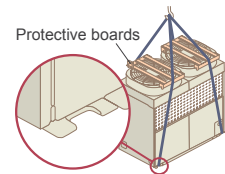

### Four-direction pipe

Four-direction piping allows a variety of installation configurations.  
Easy installation and pipe direction setting.

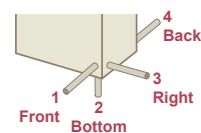

## Easy Maintenance

### Operating display

By indicating the operating status and details of failures on a PCB in the outdoor unit, better service and quick and easy maintenance are possible.

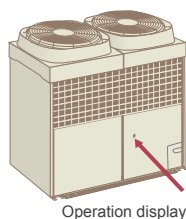

### Easy replacement

A pull-out plate ensures easy compressor replacement if necessary.

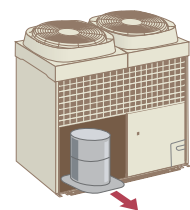

### Pump down control

Pump down can be performed from the outdoor unit using the switch on the PCB.

## Outdoor units specifications

### Dimensions Model: AO90MPCMF

(Unit : mm)

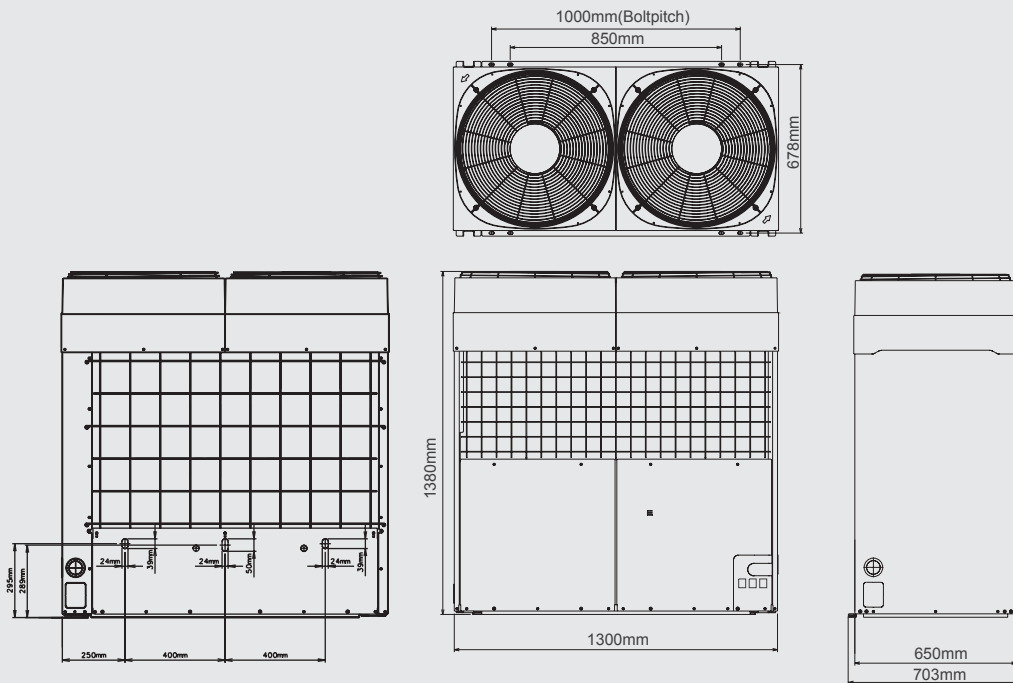

### Specifications

Rating Capacity range	HP	10
Model name	AO90MPCMF	
Maximum Connectable Indoor Unit	16	
Indoor unit connectable capacity	Cooling kW	14 to 36.4
Power source	3 phase, 380 - 415V, 50Hz	
Capacity	Cooling kW	28.0
	Heating kW	31.5
Input power	Cooling kW	9.40
	Heating kW	10.0
EER	Cooling W/W	2.98
COP	Heating	3.15
Air flow rate	High m <sup>3</sup> /h	9,800
Sound pressure level	Normal operation mode dB	57
	Silent operation mode (A)	51
Compressor motor output	kW	1.5 / 3.4 / 5.0
Heat exchanger fin	Plate fin coil	
Dimensions	Height mm	1,380
	Width mm	1,300
	Depth mm	650
Weight	kg	305
Refrigerant charge	kg	11.8
Connection pipe diameter	Liquid mm	ø12.70
	Gas mm	Discharge Gas ø19.05 / Suction Gas ø28.58
Operation range	Cooling °C	-5 to 52
	Heating °C	-15 to 21

Note : Specifications are based on the following conditions.

Cooling : Indoor temperature of 27°CDB / 19°CWB, and outdoor temperature of 35°CDB / 24°CWB.

Heating : Indoor temperature of 20°CDB / (15°CWB), and outdoor temperature of 7°CDB / 6°CWB.

Building air conditioning developed to care for people and their surroundings

### Master units

AJYA72LBTF (22.4kW)

AJYA90LBTF (28.0kW)

AJY 126LBTF (40.0kW)

### Slave units

AJYA72UBTF (22.4kW)

AJYA90UBTF (28.0kW)

AJY 126UBTF (40.0kW)



## High Efficiency

### Higher level of EER/COP

All key features of the outdoor unit result in a higher level of EER/COP

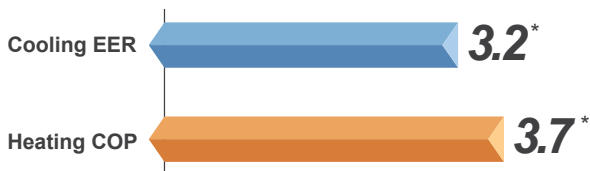

\* The data refers to a 10HP outdoor unit.

\*"EER/COP" is the coefficient of performance [ = capacity (kW) ÷ input power (kW) ].

\*EER/COP values are based on our own testing method.

### High efficiency operation

The heat exchanger is operated at maximum efficiency by effectively using the heat exchanger of each outdoor unit reciprocally.

**Example:** The larger heat exchanger than the capacity of a compressor is used in each outdoor unit. (V series)

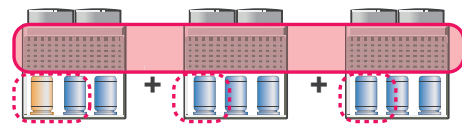

Conventional method

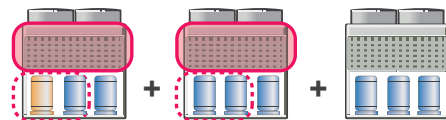

### Energy saving technology



14HP(Master unit)



**Large propeller fan:** A newly designed fan is adopted for achieving higher performance and reducing the noise level.



**Sine-wave DC Inverter Control:** By adopting Sine-Wave DC Inverter Control for smoothing the motor running, energy saving and high efficiency operation are realized



**DC inverter + Scroll compressor:** By combining the DC inverter controlled scroll compressor with the constant speed scroll compressor, an operating system of energy saving and high efficiency is realized.

# Design Versatility

## Long piping system design

With the V Series, installation up to a maximum piping length of 150m and a maximum height difference of 50m is possible. In addition, the piping can be extended up to a maximum of 60m from the first separation tube.

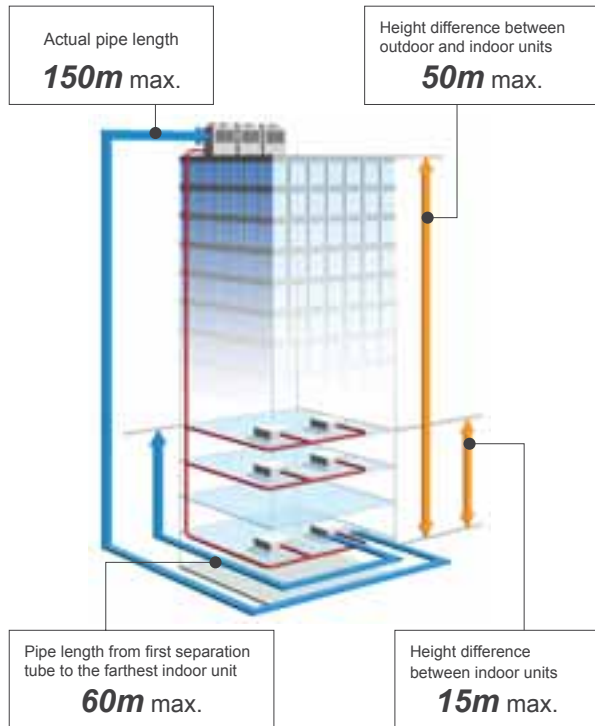

## Compact outdoor unit improves effective use of space

Installation space can be reduced freeing up valuable building space

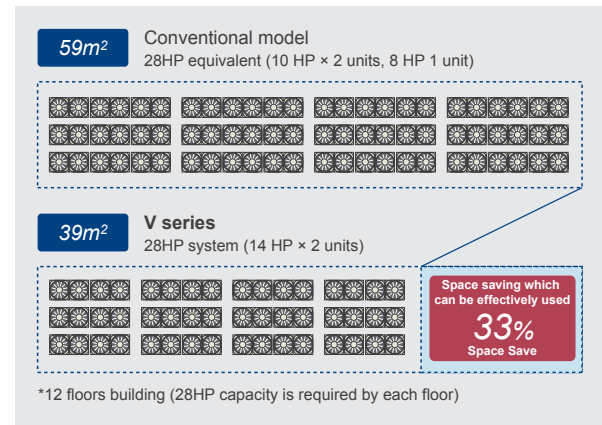

## High capacity connection

The Indoor unit connection ratio of this system can be from 50 to 150%(\*1) of the outdoor unit capacity, thus achieving a high level of diversification with up to 48 indoor units (30 to 42HP) connectable on one refrigerant system.

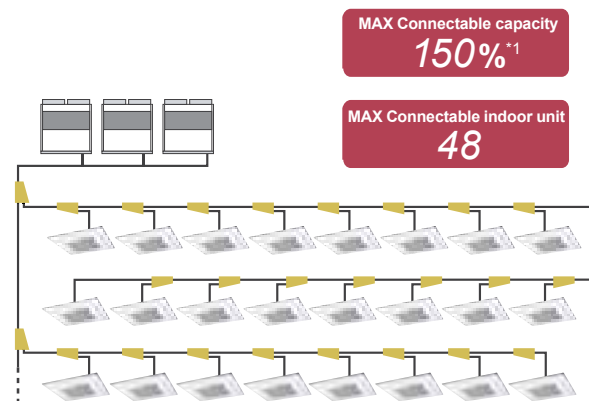

\*1. Indoor unit connectable capacity is 75 to 150% for single outdoor unit system (8 - 14HP) in case of including indoor unit model code 18 and under in the system.

Note: When all indoor units are operating at maximum capacity individual indoor units operate at a slightly lower capacity.(When connecting more than 100%)

## Wide operating ranges

World's top class low outdoor air temperature operating range is achieved. This extends the potential locations for use to the cold regions of the world.

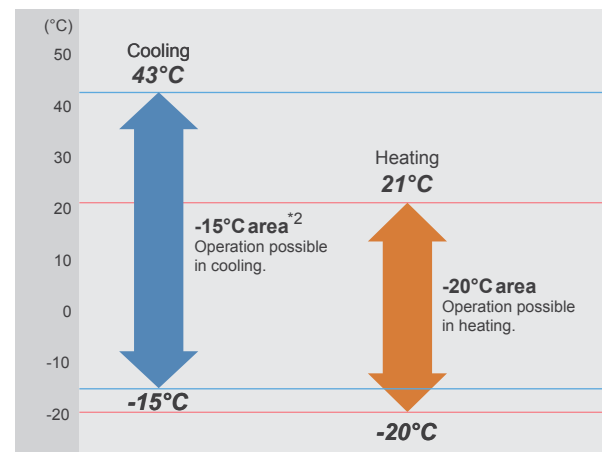

\*2. Note : When outdoor units connect multiple, operating range is from -5°C to 43°C in cooling.

## Improved Comfort

### Individual air conditioning system

Pleasant air conditioning meeting individual room requirements.

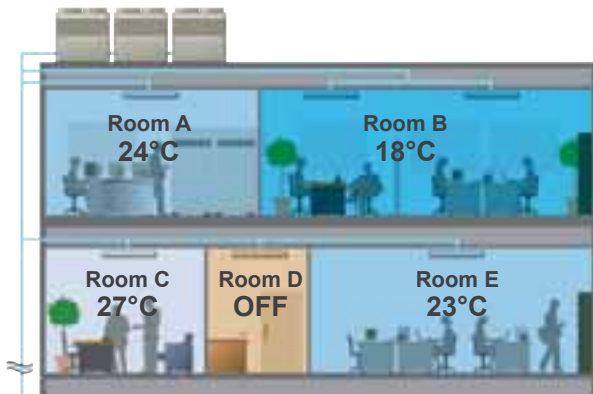

### Inverter control

Comfort and energy saving is achieved by the adoption of linear step control in conjunction with inverter and constant speed compressor combination, which allows more precise control of the necessary refrigerant circulation amount required according to the system load. This also allows for a comfortable environment by use of smooth capacity control.

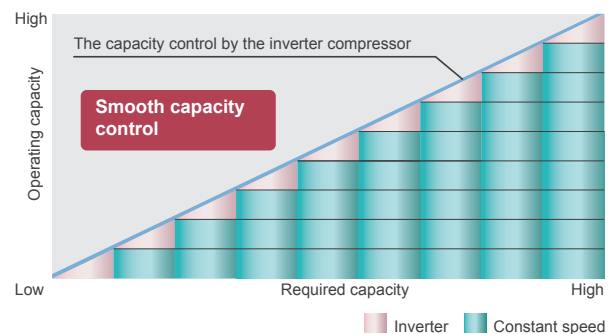

### Liquid level balance control

Balancing of the refrigerant in the system is optimized by liquid level balance control and subcool circuit between the receiver tanks of each outdoor unit. Stable refrigerant supply allows long pipe runs and achieves stable operational system performance whilst reducing unpleasant refrigerant noise.

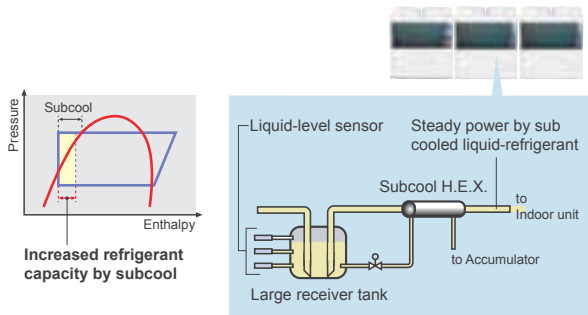

### Quiet operation

**Outdoor unit:** Quiet operating sound outdoor unit achieved. Operating noise has been reduced further through the application of a new dual casing bell mouth and large fan. The noise level can be reduced by 4-5dB (A) compared to normal operation by selecting silent operation.

**Indoor unit:** Quiet indoor units suited for bedrooms and other rooms which require quietness are available.



### Room temperature control

High precision  $\pm 0.5^\circ\text{C}$  ensures comfortable temperature control of the room. This is achieved by smooth refrigerant flow, controlled by inverter and by the indoor unit electronic expansion valve.

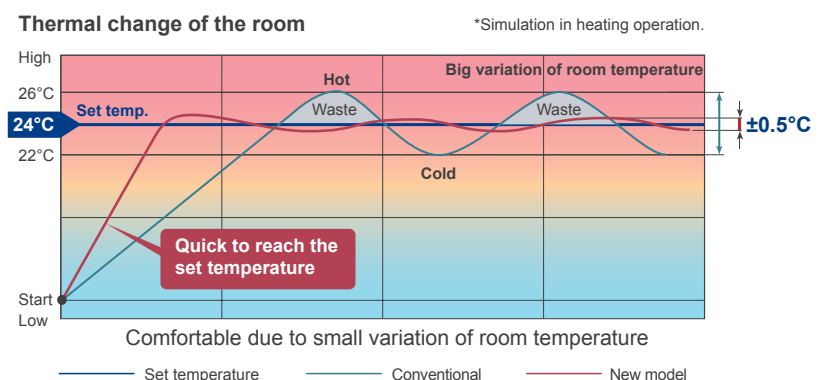

# High Reliability

## Compressor rotation control

### Improvement of long life by reducing compressor wear

In addition to control which reduces the number of times the compressor is started and stopped, the load at starting is shared and equalized by rotation control. This rotation improves the durability and reliability of each compressor.

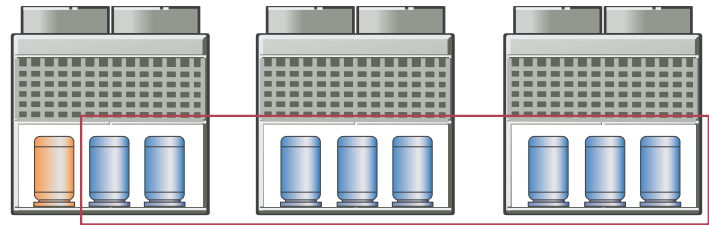

Compressor starting rotation (Constant speed)



## Emergency operation

### Outdoor unit:

There is no immediate system shutdown if trouble occurs in any compressor. The other compressors continue to operate on an emergency basis.

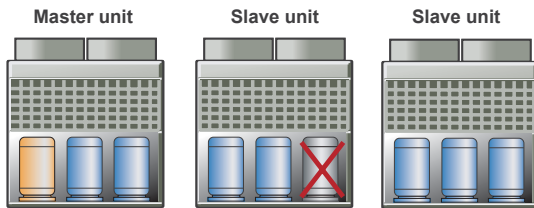

### Indoor unit:

Each indoor unit is controlled individually on the system network. This allows all indoor units continue to run unaffected even if trouble should occur at any indoor unit(s) in one system.

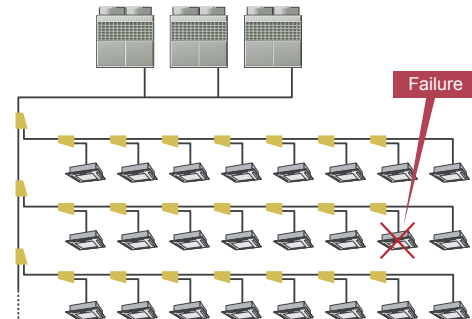

## Optimum oil control

Stable operation of compressor by optimum oil control

- 1 High trapping efficiency, large capacity cyclone type oil separator
- 2 Oil balance control which maintains uniform oil levels
- 3 Optimum EEV control for oil and refrigerant circulation

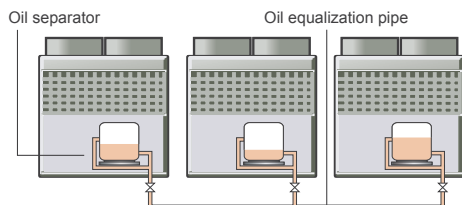

## Adoption of blue fin heat exchanger

Corrosion-resistance of the heat exchanger even in coastal areas has been improved by blue fin treatment of the outdoor unit heat exchanger.

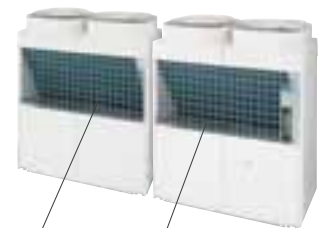

Blue fin heat exchanger

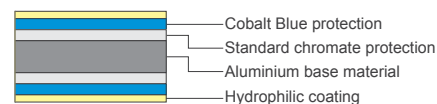



## Easy Installation

### Simple signal line connection

Connection method simplifies installation and prevents errors  
By using our wiring connection method, the wiring length is reduced compared to other wiring systems.

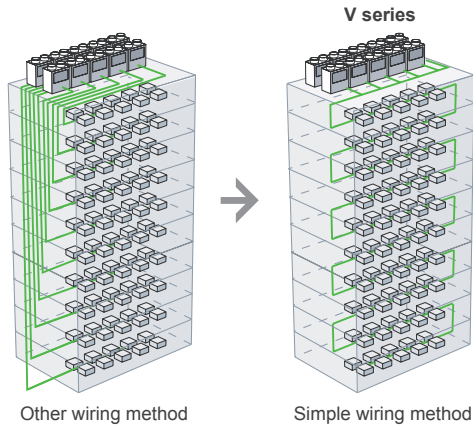

### Simple piping system

Separation tubes and headers provide connection flexibility and simplicity reducing installation costs.

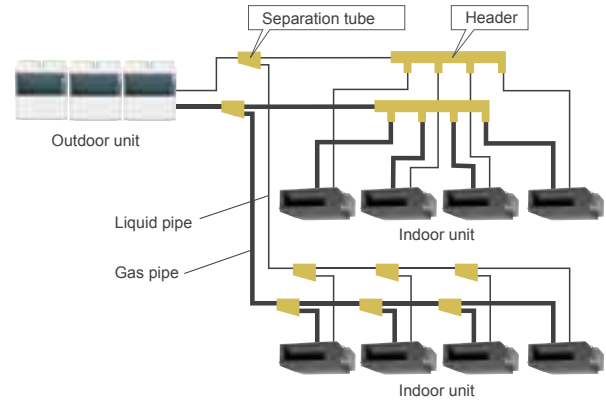

### Compact outdoor unit can be carried in a small elevator

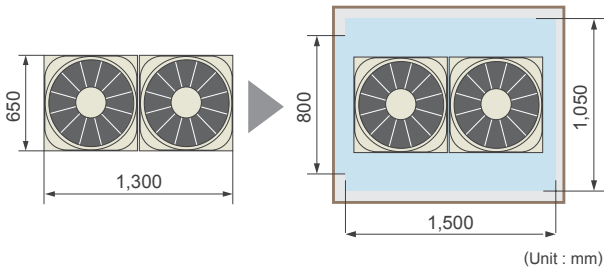

Outdoor unit goes into elevator

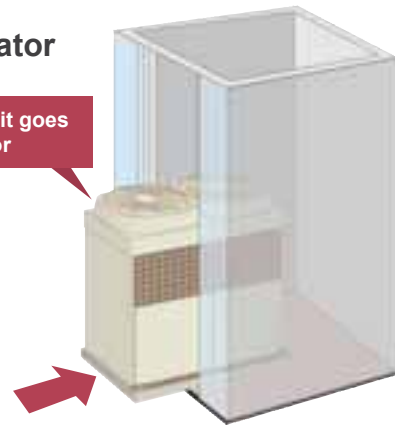

### Lifting belt hooks convenient in crane work

The outdoor unit can be lifted by crane and set down on the building roof.

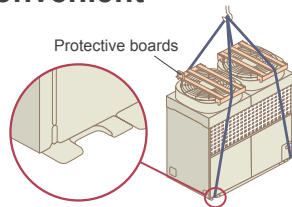

### Choice of 4-direction piping connection

4-direction piping allows a variety of installation configurations. Easy installation and pipe direction setting.

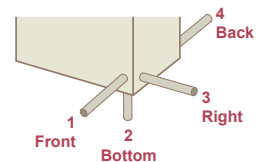

### Easy removing pallet

Delivery pallet can be easily removed and installation work can be performed speedily.

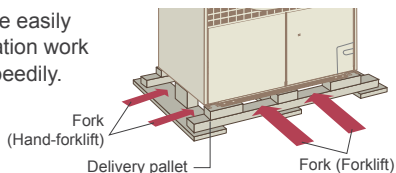

### Pipe size reduction

Use of R410A refrigerant allows for a pipe size reduction compared to the conventional system. This offers improvement in construction work and a reduction in piping costs.

### Slimming down of piping

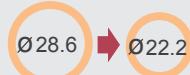

In case of gas pipe for 10HP outdoor unit



# Service & Maintenance

## Operating display

### Outdoor unit

By indicating the operating status and details of failures on a PCB in the outdoor unit, better service and quick and easy maintenance are possible.

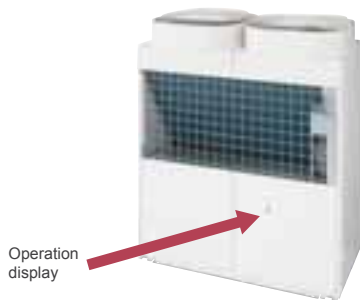

### Indoor unit

The operation status of the indoor unit can be easily checked by operation indicator. In addition, when an error occurs, the error contents are displayed and repair work can be performed quickly.

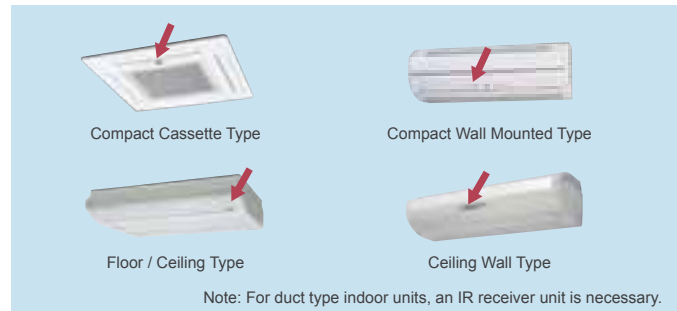

### Error display with self-diagnosis function

When an error or abnormality occurred in the system, the indoor unit No. and error code at which the error occurred are displayed at the display section of the controller. (Except wireless remote controller)

#### Wired Remote Controller

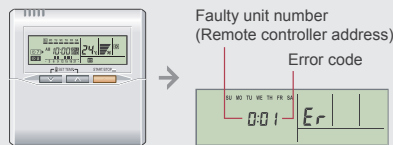

#### Simple Remote Controller

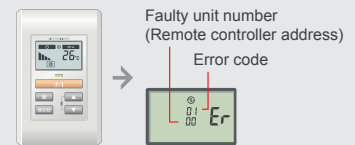

## Improves maintenance and inspection mobility (Service Tool)

Extremely portable and convenient USB type adaptor was used. Connection anywhere in the VRF network is easy. Data can be collected from device sensors at a minimum interval of 2 second, and maintenance and inspection work can be performed easily.

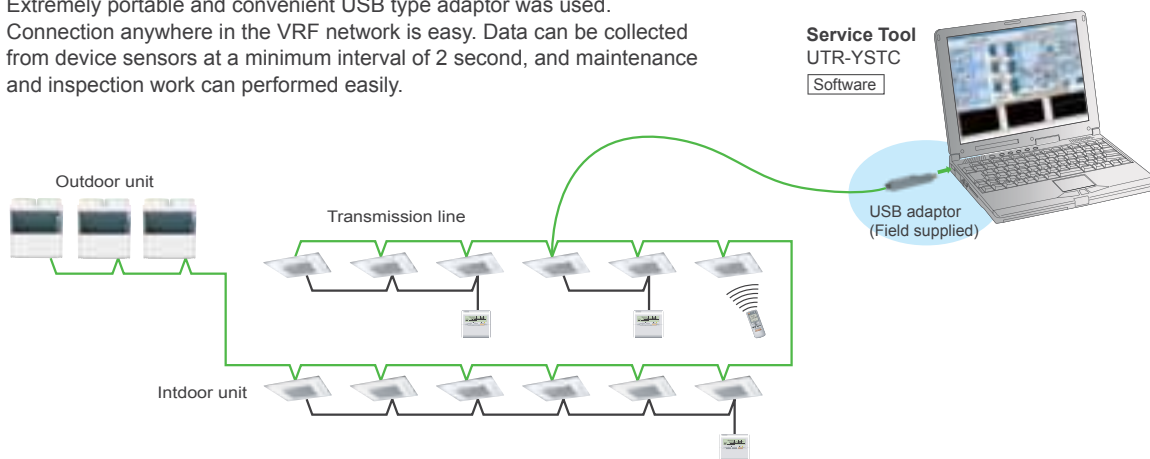

## Easy replacement

Compressor can be moved by pull-out tray which simplifies inspection and replacement work. A pull-out plate ensures easy compressor replacement if necessary.

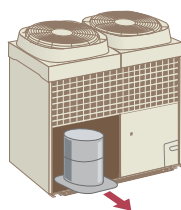

## Drain pan cleaning is easy

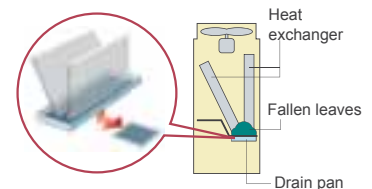

Detachable drain pan simplifies removal of fallen leaves collected in the drain pan at the bottom of the heat exchanger







## Outdoor units

### Lineup and Combination

#### Capacity Lineup

Unit	HP	Capacity	Model name
 Master units	8	22.4kW	AJYA72LBTF
	10	28.0kW	AJYA90LBTF
	14	40.0kW	AJY126LBTF
 Slave units	8	22.4kW	AJYA72UBTF
	10	28.0kW	AJYA90UBTF
	14	40.0kW	AJY126UBTF

#### Combination

Unit	HP	Capacity (kW)	Master	Slave 1	Slave 2
	8	22.4	AJYA72LBTF	—	—
	10	28.0	AJYA90LBTF	—	—
	14	40.0	AJY126LBTF	—	—
	16	44.8	AJYA72LBTF	AJYA72UBTF	—
	18	50.4	AJYA90LBTF	AJYA72UBTF	—
	20	56.0	AJYA90LBTF	AJYA90UBTF	—
	22	62.4	AJY126LBTF	AJYA72UBTF	—
	24	68.0	AJY126LBTF	AJYA90UBTF	—
	28	72.8	AJY126LBTF	AJY126UBTF	—
	26	80.0	AJYA90LBTF	AJYA72UBTF	AJYA72UBTF
	30	84.0	AJYA90LBTF	AJYA90UBTF	AJYA90UBTF
	32	90.4	AJY126LBTF	AJYA90UBTF	AJYA72UBTF
	34	96.0	AJY126LBTF	AJYA90UBTF	AJYA90UBTF
	36	102	AJY126LBTF	AJY126UBTF	AJYA72UBTF
	38	108	AJY126LBTF	AJY126UBTF	AJYA90UBTF
	42	120	AJY126LBTF	AJY126UBTF	AJY126UBTF

### Specifications

Rating Capacity range		HP	8	10	14	16	18	20	22
Unit 1			AJYA72LBTF	AJYA90LBTF	AJY126LBTF	AJYA72LBTF	AJYA90LBTF	AJYA90LBTF	AJY126LBTF
Unit 2						AJYA72UBTF	AJYA72UBTF	AJYA90UBTF	AJYA72UBTF
Unit 3									AJYA72UBTF
Maximum Connectable Indoor Unit			15	16	16	30	32	32	32
Indoor unit connectable capacity			11.2-33.6	14.0-42.0	20.0-60.0	22.4-67.2	25.2-75.6	28.0-84.0	31.2-93.6
Power source			3Phase 400V 50Hz						
Capacity	Cooling	kW	22.4	28.0	40.0	44.8	50.4	56.0	62.4
	Heating	kW	25.0	31.5	45.0	50.0	56.5	63.0	70.0
Input power	Cooling	kW	7.00	8.75	13.3	14.0	15.8	17.5	20.3
	Heating	kW	6.76	8.51	13.2	13.5	15.3	17.0	20.0
EER	Cooling	W/W	3.20	3.20	3.00	3.20	3.20	3.20	3.07
COP	Heating	W/W	3.70	3.70	3.40	3.70	3.70	3.70	3.50
Air flow rate	High	m³/h	10700	10700	10800	10700 x 2	10700 x 2	10700 x 2	10800+10700
Sound pressure level*2	Cooling	dB (A)	58	58	60	61	61	61	62
	Heating	dB (A)	60	60	62	63	63	63	64
Compressor motor output		kW	3.0 + 4.6	3.0 + 4.6	3.0 + 4.6 + 4.6	3.0 + 4.6 / 3.7 + 3.7	3.0 + 4.6 / 3.7 + 3.7	3.0 + 4.6 / 4.6 + 4.6	3.0 + 4.6 + 4.6 / 3.7 + 3.7
Heat exchanger fin			Blue fin	Blue fin	Blue fin	Blue fin	Blue fin	Blue fin	Blue fin
Dimensions	Height	mm	1500	1500	1500	1500	1500	1500	1500
	Width	mm	1300	1300	1300	1300	1300	1300	1300
	Depth	mm	650	650	650	650	650	650	650
Weight		kg	267	267	371	267 + 270	267 + 270	267 + 270	371 + 270
Refrigerant charge		kg	11.8	11.8	11.8	11.8 + 11.8	11.8 + 11.8	11.8 + 11.8	11.8 + 11.8
Connection pipe diameter	Liquid	mm	ø12.70	ø12.70	ø12.70	ø12.70	ø15.88	ø15.88	ø15.88
	Gas	mm	ø22.22	ø22.22	ø28.58	ø28.58	ø28.58	ø28.58	ø34.92
Operation range	Cooling	°C	-15 to 43	-15 to 43	-15 to 43	-5 to 43	-5 to 43	-5 to 43	-5 to 43
	Heating	°C	-20 to 21	-20 to 21	-20 to 21	-20 to 21	-20 to 21	-20 to 21	-20 to 21

Note : Specifications are based on the following conditions.

Cooling : Indoor temperature of 27°CDB / 19°CWB, and outdoor temperature of 35°CDB / 24°CWB.

Heating : Indoor temperature of 20°CDB / (15°CWB), and outdoor temperature of 7°CDB / 6°CWB.

Pipe length : 7.5m; Height difference between outdoor unit and indoor unit : 0m.

# Dimensions





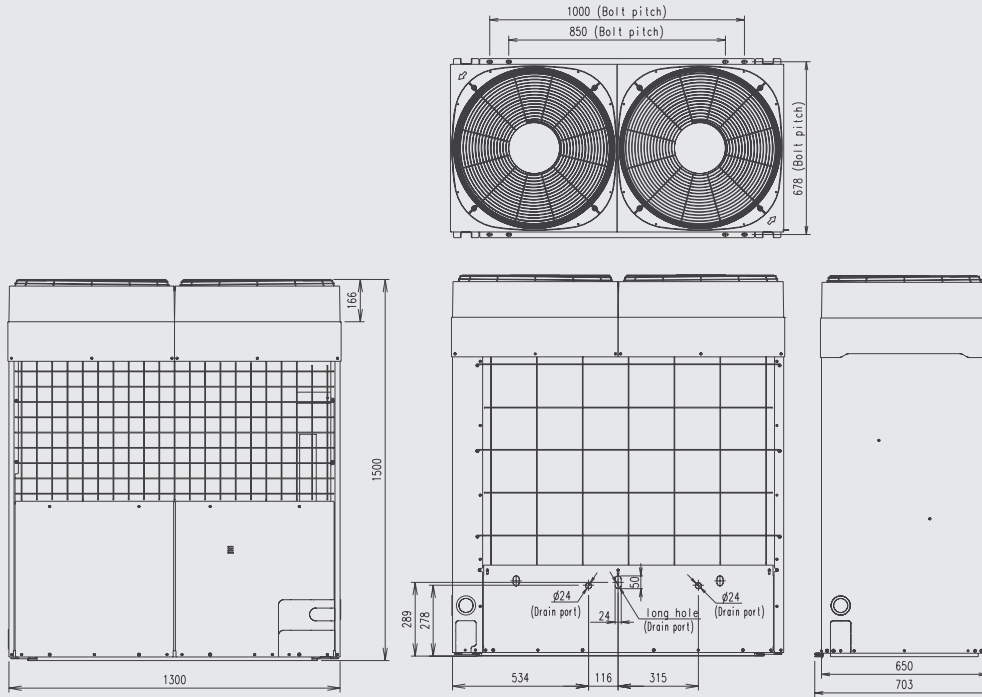



















Master unit and slave unit are same dimensions.

(Unit : mm)



24		26		28		30		32		34		36		38		42	
AJY126LBTF	AJYA90LBTF	AJY126LBTF	AJYA90LBTF	AJY126LBTF	AJYA90LBTF	AJY126LBTF	AJYA90LBTF	AJY126LBTF	AJYA90LBTF	AJY126LBTF	AJYA90LBTF	AJY126LBTF	AJYA90LBTF	AJY126LBTF	AJYA90LBTF	AJY126LBTF	AJYA90LBTF
AJYA90UBTF	AJYA72UBTF	AJY126UBTF	AJYA90UBTF	AJY126UBTF	AJYA90UBTF	AJY126UBTF	AJYA90UBTF	AJY126UBTF	AJYA90UBTF	AJY126UBTF	AJYA90UBTF	AJY126UBTF	AJYA90UBTF	AJY126UBTF	AJYA90UBTF	AJY126UBTF	AJYA90UBTF
32	32	32	48	48	48	48	48	48	48	48	48	48	48	48	48	48	48
34.0-102	36.4-109	40.0-120	42.0-126	45.2-135	48.0-144	51.0-153	54.0-162	60.0-180									
3Phase 400V 50Hz																	
68.0	72.8	80.0	84.0	90.4	96.0	102	108	115	122	135							
22.1	22.8	26.7	26.3	29.1	30.8	33.7	35.4	40.0									
21.7	22.0	26.5	25.5	28.5	30.3	33.2	35.0	39.7									
3.08	3.20	3.00	3.20	3.11	3.11	3.04	3.05	3.00									
3.52	3.70	3.40	3.70	3.56	3.57	3.27	3.47	3.40									
10800+10700	10700 x 3	10800 x 2	10700 x 3	10800+10700 x 2	10800+10700 x 2	10800 x 2+10700	10800 x 2+10700	10800 x 3									
62	62	62	62	63	63	63	64	64									
64	64	64	64	65	65	65	66	66									
3.0 + 4.6 + 4.6 / 4.6 + 4.6	3.0 + 4.6 / 3.7 + 3.7 / 3.7 + 3.7	3.0 + 4.6 + 4.6 / 4.6 + 4.6 + 4.6	3.0 + 4.6 / 4.6 + 4.6 / 4.6 + 4.6	3.0 + 4.6 + 4.6 / 4.6 + 4.6 / 3.7 + 3.7	3.0 + 4.6 + 4.6 / 4.6 + 4.6 / 4.6 + 4.6	3.0 + 4.6 + 4.6 / 4.6 + 4.6 + 4.6 / 3.7 + 3.7	3.0 + 4.6 + 4.6 / 4.6 + 4.6 + 4.6 / 4.6 + 4.6	3.0 + 4.6 + 4.6 / 4.6 + 4.6 + 4.6 / 4.6 + 4.6 + 4.6	3.0 + 4.6 + 4.6 / 4.6 + 4.6 + 4.6 / 4.6 + 4.6 + 4.6								
Blue fin	Blue fin	Blue fin	Blue fin	Blue fin	Blue fin	Blue fin	Blue fin	Blue fin	Blue fin	Blue fin	Blue fin	Blue fin	Blue fin	Blue fin	Blue fin	Blue fin	Blue fin
1500	1500	1500	1500	1500	1500	1500	1500	1500	1500	1500	1500	1500	1500	1500	1500	1500	1500
1300	1300	1300	1300	1300	1300	1300	1300	1300	1300	1300	1300	1300	1300	1300	1300	1300	1300
650	650	650	650	650	650	650	650	650	650	650	650	650	650	650	650	650	650
371 + 270	267 + 270 + 270	371 + 374	267 + 270 + 270	371 + 270 + 270	371 + 270 + 270	371 + 374 + 270	371 + 374 + 270	371 + 374 + 374									
11.8 + 11.8	11.8 + 11.8 + 11.8	11.8 + 11.8	11.8 + 11.8 + 11.8	11.8 + 11.8 + 11.8	11.8 + 11.8 + 11.8	11.8 + 11.8 + 11.8	11.8 + 11.8 + 11.8	11.8 + 11.8 + 11.8									
ø15.88	ø15.88	ø15.88	ø15.88	ø19.05	ø19.05	ø19.05	ø19.05	ø19.05									
ø34.92	ø34.92	ø34.92	ø34.92	ø34.92	ø34.92	ø34.92	ø41.27	ø41.27									
-5 to 43	-5 to 43	-5 to 43	-5 to 43	-5 to 43	-5 to 43	-5 to 43	-5 to 43	-5 to 43									
-20 to 21	-20 to 21	-20 to 21	-20 to 21	-20 to 21	-20 to 21	-20 to 21	-20 to 21	-20 to 21									

















## Indoor units lineup

Capacity range (kW)	2.20	2.20	3.60	4.05	5.30	5.70	
Model code	7	9	12	14	18	20	
<b>Compact Cassette</b>	 AUXB07LATF	 AUXB09LATF	 AUXB12LATF	 AUXB14LATF	 AUXB18LATF		
<b><small>Slim Type</small> Cassette</b>						 AUYA20LATF	
<b><small>Silent model</small> Compact Duct</b>	 ARXB07LALF	 ARXB09LALF	 ARXB12LALF	 ARXB14LALF	 ARXB18LALF		
<b><small>Silent model</small> Low Static Pressure Duct</b>							
<b>Duct</b>							
<b>High Static Pressure Duct</b>							
<b>Floor / Ceiling</b>			 ABYA12LATF	 ABYA14LATF	 ABYA18LATF		
<b>Ceiling</b>							
<b><small>Comfort model</small> Compact Wall Mounted*2</b>	 ASYE07LACF	 ASYE09LACF	 ASYE12LACF	 ASYE14LACF			
<small>With this model, connection of EV kit is necessary.</small>							
<b>Wall Mounted</b>					 ASYA18LATF		
<b>Ceiling Wall</b>	 AWYA07LATF	 AWYA09LATF	 AWYA12LATF	 AWYA14LATF	 AWYA18LATF		

\*1:ARXC90 model can not be connected to S series outdoor unit.

\*2:Compact wall mounted model can not be connected S series Heat Recovery outdoor unit.

11 Types, 50 Models, Capacity range from 2.2kW to 25.4kW  
 Indoor units of S series and V series are compatible

	6.80	7.05	8.80	10.5	12.7	14.1	17.0	25.4
	24	25	30	36	45	54	60	90
		 Slim Type AUYA25LATF	 Slim Type AUYA30LATF					
								
								
								
								
								
								
								

## Indoor units specifications

### Compact Cassette



Model name		AUXB07LATF	AUXB09LATF	AUXB12LATF	AUXB14LATF	AUXB18LATF
Power source		230V~, 50Hz				
Capacity	Cooling	2.20	2.80	3.60	4.00	5.00
	Heating	2.50	3.20	4.10	4.50	5.45
Input power		28	28	52	52	50
Airflow rate	High	530	530	580	580	640
	Med	480	480	520	520	540
	Low	410	410	460	460	470
Sound pressure level	High	38	38	41	41	44
	Med	35	35	37	37	38
	Low	31	31	34	34	35
Dimensions (H x W x D)		230 x 570 x 570	230 x 570 x 570	230 x 570 x 570	230 x 570 x 570	230 x 570 x 570
Weight		18	18	18	18	18
Connection pipe diameter	Liquid (Flare)	ø6.35	ø6.35	ø6.35	ø6.35	ø9.52
	Gas (Flare)	ø12.7	ø12.7	ø12.7	ø12.7	ø15.88
Grille		UTG-UDYD-W (Option)				

Note : Specifications are based on the following conditions.

Cooling : Indoor temperature of 27°CDB / 19°CWB, and outdoor temperature of 35°CDB / 24°CWB.

Heating : Indoor temperature of 20°CDB / (15°CWB), and outdoor temperature of 7°CDB / 6°CWB.

Pipe length : 7.5 m; Height difference between outdoor unit and indoor unit : 0 m.

Voltage : 230 [V].

### Cassette

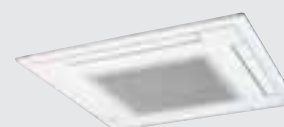

Model name		AUYA20LATF	AUYA25LATF	AUYA30LATF	AUYA36LATF	AUYA45LATF	AUYA54LATF
Power source		230V~, 50Hz					
Capacity	Cooling	5.70	7.05	8.80	10.5	12.7	14.1
	Heating	5.80	7.85	9.10	12.7	13.7	15.8
Input power		104	124	140	175	190	219
Airflow rate	High	1,000	1,100	1,250	1,500	1,550	1,700
	Med	840	940	1,050	1,300	1,350	1,420
	Low	700	780	840	1,100	1,100	1,200
Sound pressure level	High	41	43	46	47	48.5	51.5
	Med	37	40	43	42.5	46	47.5
	Low	33	35	37	38	41	43.5
Dimensions (H x W x D)	(Main body)	246 x 830 x 830	246 x 830 x 830	246 x 830 x 830	296 x 830 x 830	296 x 830 x 830	296 x 830 x 830
	(With Panel)	265 x 940 x 940	265 x 940 x 940	265 x 940 x 940	315 x 940 x 940	315 x 940 x 940	315 x 940 x 940
Weight		34	34	34	40	40	40
Connection pipe diameter	Liquid (Flare)	ø9.52	ø9.52	ø9.52	ø9.52	ø9.52	ø9.52
	Gas (Flare)	ø15.88	ø15.88	ø15.88	ø19.05	ø19.05	ø19.05

Note : Specifications are based on the following conditions.

Cooling : Indoor temperature of 27°CDB / 19°CWB, and outdoor temperature of 35°CDB / 24°CWB.

Heating : Indoor temperature of 20°CDB / (15°CWB), and outdoor temperature of 7°CDB / 6°CWB.

Pipe length : 7.5 m; Height difference between outdoor unit and indoor unit : 0 m.

Voltage : 230 [V].



## Compact Duct Low Static Pressure Duct Duct



Model name		ARXB07 LALF	ARXB09 LALF	ARXB12 LALF	ARXB14 LALF	ARXB18 LALF	ARXB25 LATF	ARXB30 LATF	ARXB36 LATF	ARXB45 LATF	ARXA25 LATF	ARXA30 LATF	ARXA36 LATF	ARXA45 LATF
Power source		230V~, 50Hz												
Capacity	Cooling	2.20	2.80	3.60	4.00	5.30	7.00	8.80	10.5	12.7	7.00	8.80	10.5	12.7
	Heating	2.50	3.20	4.10	4.80	5.60	7.70	9.50	12.7	14.3	7.70	9.50	12.7	14.3
Input power		31.2	32.6	55.0	63.0	103.0	155	171	216	246	161	172	220	312
Airflow rate	High	330	370	560	610	950	1,090	1,200	1,440	1,580	1,100	1,400	1,750	1,800
	Med	300	340	500	550	790	970	1,090	1,270	1,450	1,000	1,300	1,650	1,600
	Low	270	310	420	470	620	870	970	1,160	1,320	900	1,200	1,550	1,500
Static pressure range		Pa	0 to 50	0 to 50	0 to 50	0 to 50	0 to 80	0 to 80	0 to 80	0 to 80	30 to 150	30 to 150	30 to 150	30 to 150
Sound pressure level	High	29	31	30	31	40	29	31	35	37	38	40	43	44
	Med	27	29	28	29	35	26	28	32	35	36	38	41	42
	Low	24	27	25	26	30	24	26	30	33	34	36	39	40
Dimensions (H x W x D)		mm	217x663x595	217x663x595	217x953x595	217x953x595	270x1,135x700	270x1,135x700	270x1,135x700	270x1,135x700	270x1,135x700	270x1,135x700	270x1,135x700	270x1,135x700
Weight		kg	18	18	25	25	43	43	43	45	43	43	43	45
Connection pipe diameter	Liquid (Flare)	mm	ø6.35	ø6.35	ø6.35	ø6.35	ø9.52	ø9.52	ø9.52	ø9.52	ø9.52	ø9.52	ø9.52	ø9.52
	Gas (Flare)	mm	ø12.7	ø12.7	ø12.7	ø12.7	ø15.88	ø15.88	ø15.88	ø19.05	ø19.05	ø15.88	ø15.88	ø19.05

Note : Specifications are based on the following conditions.

Cooling : Indoor temperature of 27°CDB / 19°CWB, and outdoor temperature of 35°CDB / 24°CWB.

Heating : Indoor temperature of 20°CDB / (15°CWB), and outdoor temperature of 7°CDB / 6°CWB.

Pipe length : 7.5 m; Height difference between outdoor unit and indoor unit : 0 m.

Voltage : 230 [V]; Standard static pressure : 0 Pa (ARXB07LALF, ARXB09LALF, ARXB12LALF, ARXB18LALF, ARXB25LATF, ARXB30LATF, ARXB36LATF, ARXB45LATF)

Voltage : 230 [V]; Standard static pressure : 100 Pa (ARXA25LATF, ARXA30LATF, ARXA36LATF, ARXA45LATF)

## High Static Pressure Duct



Model name		ARXC36LATF	ARXC45LATF	ARXC60LATF	ARXC90LATF
Power source		230V~, 50Hz			3Phase 400V, 50Hz   230V~, 50Hz
Capacity	Cooling	10.5	12.7	17.0	25.4
	Heating	12.7	14.3	18.2	29.5
Input power		405	427	427	970
Airflow rate	High	2,500	3,500	3,500	3,950
	Med	1,950	3,000	3,000	-
	Low	1,450	2,460	2,460	-
Static pressure range		Pa	100 to 200	100 to 250	100 to 300
Sound pressure level	High	45	49	49	50
	Med	38	45	45	-
	Low	32	42	42	-
Dimensions (H x W x D)		mm	400 x 1,050 x 500	400 x 1,050 x 500	450 x 1,550 x 700
Weight		kg	45	45	82
Connection pipe diameter	Liquid (Flare)	mm	ø9.52(Flare)	ø9.52 (Flare)	ø12.7 (Brazing)
	Gas (Flare)	mm	ø19.05 (Flare)	ø19.05 (Flare)	ø22.22(Brazing)

Note : Specifications are based on the following conditions.

Cooling : Indoor temperature of 27°CDB / 19°CWB, and outdoor temperature of 35°CDB / 24°CWB.

Heating : Indoor temperature of 20°CDB / (15°CWB), and outdoor temperature of 7°CDB / 6°CWB.

Pipe length : 7.5 m; Height difference between outdoor unit and indoor unit : 0 m.

Voltage : 230 [V]; Standard static pressure : 100 Pa (ARXC36LATF, ARXC45LATF, ARXC60LATF).

Voltage : 400 [V]; Standard static pressure : 200 Pa (ARXC90LATF).

## Indoor units specifications

### Floor / Ceiling



Model name		ABYA12LATF	ABYA14LATF	ABYA18LATF	ABYA24LATF
Power source		230V~ , 50Hz			
Capacity	Cooling	3.60	4.05	5.30	6.60
	Heating	4.10	5.00	5.60	7.70
Input power		57	57	88	88
Airflow rate	High	640	640	780	880
	Med	560	560	650	740
	Low	480	480	550	630
Sound pressure level	High	40	40	46	48
	Med	37	37	41.5	45
	Low	34	34	37	41
Dimensions (H x W x D)		199 x 990 x 655	199 x 990 x 655	199 x 990 x 655	199 x 990 x 655
Weight		28	28	28	28
Connection pipe diameter	Liquid (Flare)	ø6.35	ø6.35	ø9.52	ø9.52
	Gas (Flare)	ø12.7	ø12.7	ø15.88	ø15.88

Note : Specifications are based on the following conditions.

Cooling : Indoor temperature of 27°CDB / 19°CWB, and outdoor temperature of 35°CDB / 24°CWB.

Heating : Indoor temperature of 20°CDB / (15°CWB), and outdoor temperature of 7°CDB / 6°CWB.

Pipe length : 7.5 m; Height difference between outdoor unit and indoor unit : 0 m.

Voltage : 230 [V].

### Ceiling



Model name		ABYA30LATF	ABYA36LATF	ABYA45LATF	ABYA54LATF
Power source		230V~ , 50Hz			
Capacity	Cooling	8.80	10.5	12.7	14.1
	Heating	9.10	12.7	13.7	15.8
Input power		124	144	160	180
Airflow rate	High	1,450	1,660	1,850	2,200
	Med	1,280	1,500	1,660	2,000
	Low	980	1,270	1,430	1,800
Sound pressure level	High	42	45	48	52
	Med	39	42	46	50
	Low	35	37	41	46
Dimensions (H x W x D)		240 x 1,660 x 700	240 x 1,660 x 700	240 x 1,660 x 700	240 x 1,660 x 700
Weight		48	48	48	48
Connection pipe diameter	Liquid (Flare)	ø9.52	ø9.52	ø9.52	ø9.52
	Gas (Flare)	ø15.88	ø19.05	ø19.05	ø19.05

Note : Specifications are based on the following conditions.

Cooling : Indoor temperature of 27°CDB / 19°CWB, and outdoor temperature of 35°CDB / 24°CWB.

Heating : Indoor temperature of 20°CDB / (15°CWB), and outdoor temperature of 7°CDB / 6°CWB.

Pipe length : 7.5 m; Height difference between outdoor unit and indoor unit : 0 m.

Voltage : 230 [V].

## Compact Wall Mounted



Model name		ASYE07LACF	ASYE09LACF	ASYE12LACF	ASYE14LACF
Power source		230V~, 50Hz			
Capacity	Cooling	2.20	2.80	3.60	4.00
	Heating	2.50	3.20	4.10	4.80
Input power		13	13	17	19
Airflow rate	High	490	490	560	600
	Med	450	450	480	490
	Low	370	370	420	420
Sound pressure level	High	34	34	38	39
	Med	32	32	34	35
	Low	26	26	30	30
Dimensions (H x W x D)		275 x 790 x 215	275 x 790 x 215	275 x 790 x 215	275 x 790 x 215
Weight		9	9	9	9
Connection pipe diameter	Liquid (Flare)	ø6.35	ø6.35	ø6.35	ø6.35
	Gas (Flare)	ø12.7	ø12.7	ø12.7	ø12.7
EV Kit		UTR-EV09XA (Option)		UTR-EV14XA (Option)	

## Wall Mounted



Model name		AS YA18LATF	AS YA24LATF	AS YA30LATF
Power source		230V~, 50Hz		
Capacity	Cooling	5.40	6.90	8.00
	Heating	5.60	7.80	8.80
Input power		38	50	60
Airflow rate	High	800	970	1,040
	Med	650	870	910
	Low	550	750	730
Sound pressure level	High	41	45	47.5
	Med	36.5	41	44
	Low	33	37	39.5
Dimensions (H x W x D)		320 x 1,120 x 220	320 x 1,120 x 220	320 x 1,120 x 220
Weight		16	16	16
Connection pipe diameter	Liquid (Flare)	ø9.52	ø9.52	ø9.52
	Gas (Flare)	ø15.88	ø15.88	ø15.88

## Ceiling Wall



Model name		AWYA07LATF	AWYA09LATF	AWYA12LATF	AWYA14LATF	AWYA18LATF	AWYA24LATF	AWYA30LATF
Power source		230V~, 50Hz						
Capacity	Cooling	2.20	2.80	3.60	4.30	5.40	6.90	8.00
	Heating	2.50	3.20	4.10	4.90	5.60	7.80	8.80
Input power		16	19	20	21	30	40	50
Airflow rate	High	380	480	600	650	760	900	950
	Med	330	420	520	570	660	780	870
	Low	290	390	470	490	560	650	780
Sound pressure level	High	34	35	35	37	40	44	47
	Med	32	32	33	35	37	41	45
	Low	30	30	31	32	34	37	42
Dimensions (H x W x D)		270 x 1,150 x 285	270 x 1,150 x 285	270 x 1,150 x 285	270 x 1,150 x 285	270 x 1,150 x 285	270 x 1,150 x 285	270 x 1,150 x 285
Weight		16	16	16	16	16	16	16
Connection pipe diameter	Liquid (Flare)	ø6.35	ø6.35	ø6.35	ø6.35	ø9.52	ø9.52	ø9.52
	Gas (Flare)	ø12.7	ø9.52	ø12.7	ø12.7	ø15.88	ø15.88	ø15.88

Note : Specifications are based on the following conditions.

Cooling : Indoor temperature of 27°CDB / 19°CWB, and outdoor temperature of 35°CDB / 24°CWB.

Heating : Indoor temperature of 20°CDB / (15°CWB), and outdoor temperature of 7°CDB / 6°CWB.

Pipe length : 7.5 m; Height difference between outdoor unit and indoor unit : 0 m.

Voltage : 230 [V].

# AIRSTAGE™ V-II

Smart and cutting edge design  
 Extensive lineup from 8HP to 48HP  
 in 2HP increment  
 Connectable indoor unit capacity  
 ratio up to 150%



8, 10, 12HP **NEW**

14, 16HP **NEW**

## High Efficiency

### Significantly improved EER/COP

Significantly greater efficiency is realized by the use of a DC twin rotary compressor, inverter technology, and large heat exchanger.

\* "EER/COP" is the coefficient of performance  
 [ = capacity (kW) ÷ input power (kW) ].  
 \*EER/COP values are based on our own testing method.  
 \*1. The data refers to a 8HP outdoor unit.

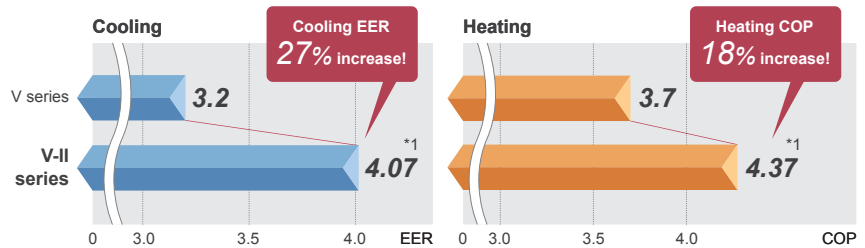

### Energy saving technology that boosted operation efficiency



**DC Fan motor:**  
 Power consumption has been reduced by 25% compared to previous models by using a compact and high performance DC fan motor.

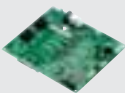

**Sine-wave DC inverter control:**  
 High efficiency operation is realized by using a sine wave DC inverter control.



**DC twin rotary compressor:**  
 Significantly greater efficiency is realized by use of a large capacity DC twin rotary compressor with substantially increased refrigerant intake and compression efficiency.



**4-face heat exchanger:** Heat exchange efficiency is significantly improved by the introduction of a new 4-face heat exchanger that increases effective surface area.



Surface area  
**1.7 times!**

V-II series

In multiple outdoor unit installations, the unique front intake design improves airflow into the Heat Exchanger.

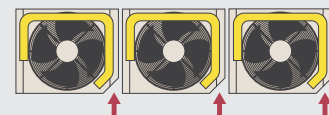

# Energy Efficiency Combination

## Choice of space saving or energy efficiency combinations

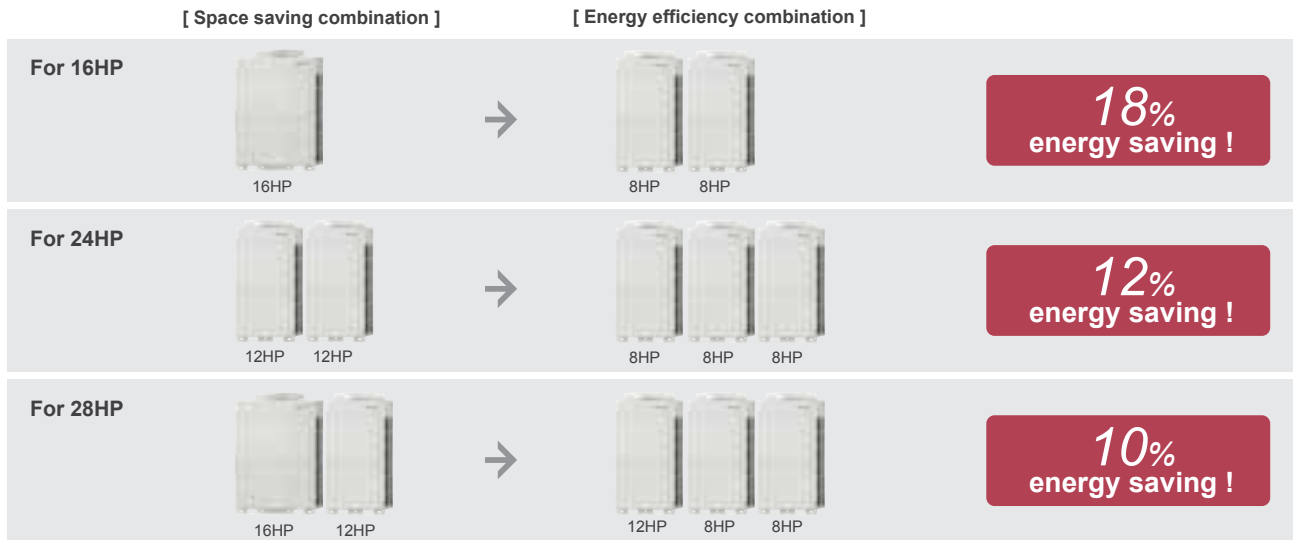

(Comparison of Average COP)

## Various Energy Saving Features

### Economy operation

Economy operation can be set by remote controller. The temperature setting is offset automatically over a certain period of time.

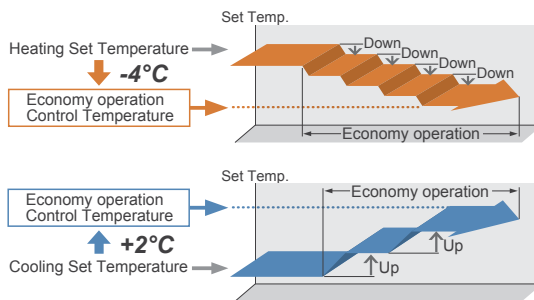

### Capacity shift operation

When the heat load is minimal, capacity can be reduced according to surrounding conditions.

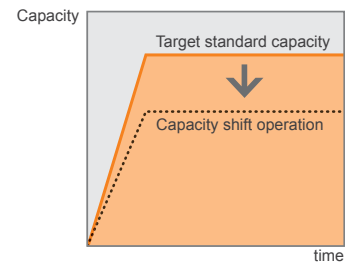

### Room temperature set point limitation

The minimum and maximum temperature range can be set giving further energy saving while considering the comfort of the occupants.

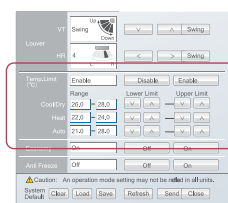

Operation setting (System Controller)

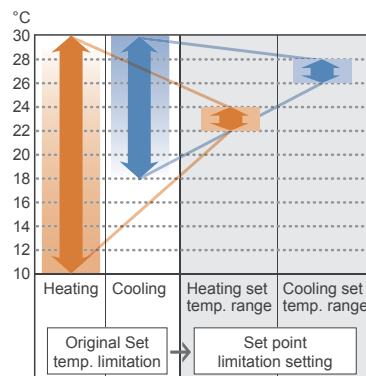

### Auto-off timer

Each remote controller is equipped with an OFF timer function that automatically stops operation when a fixed time has elapsed from the start of operation. This prevents wasteful operation. (NB Except simple remote controller)

## Design Versatility

### Overall piping length 1,000m

World's top class overall piping length of 1,000m allows for application in a wide variety buildings.

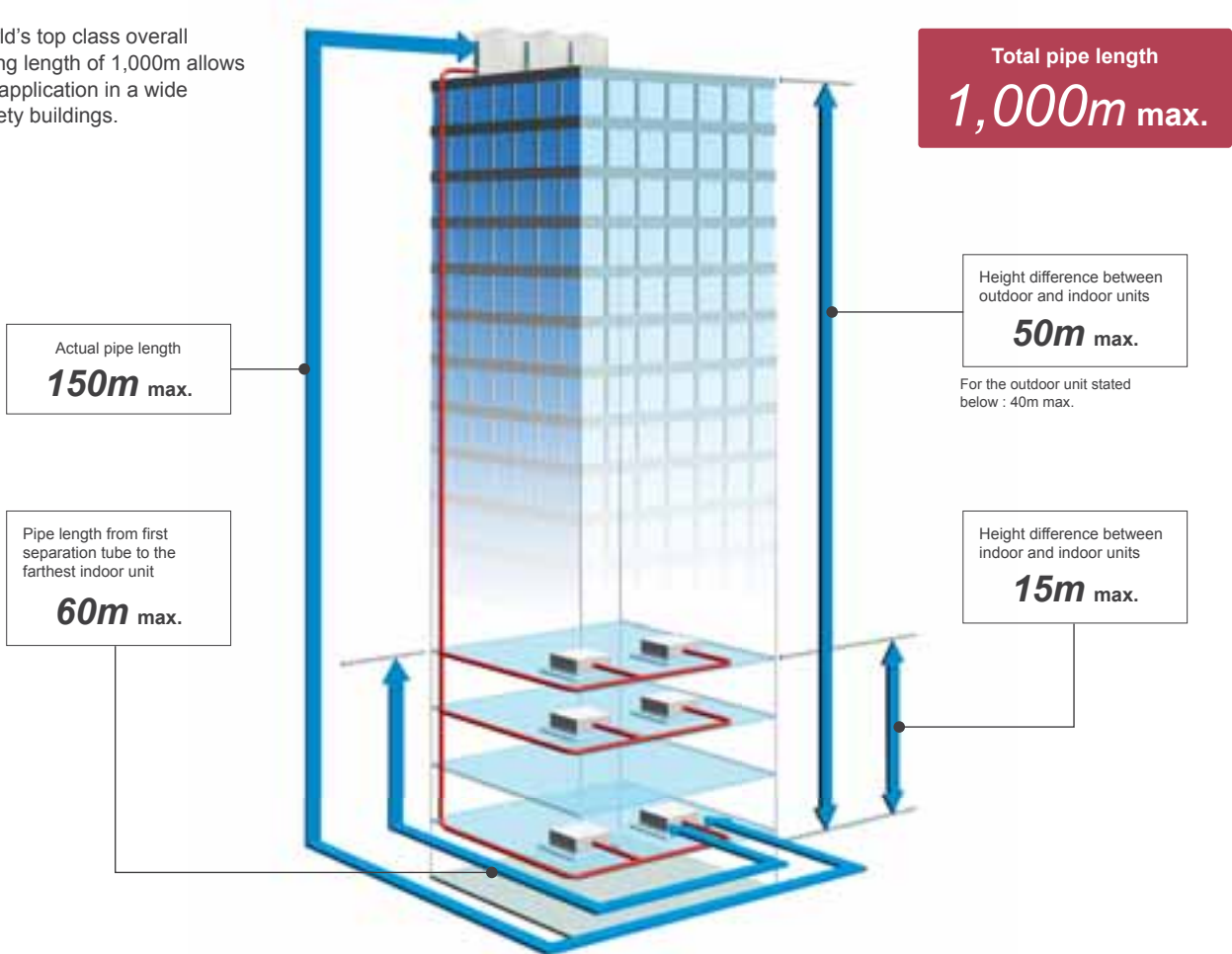

### High static pressure of 80Pa

The outdoor unit can have a condenser hood easily connected with a static pressure of 80Pa standard. This allows outdoor units to be installed within plant rooms in high rise buildings.

Powerful discharge with an external static pressure of 80Pa.

Previous model



V-II series



**80Pa**  
as standard

Large diameter fan and DC motor has been utilized allowing an external static pressure of 80Pa. This is approximately 2.6 times greater than the previous model.

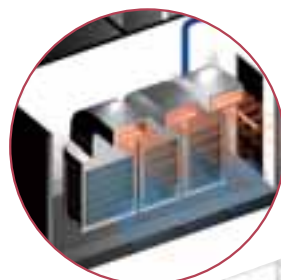

Installation Example





## Space saving and compact size

Compact size has been achieved by significantly reducing the width of the outdoor units compared to previous models.

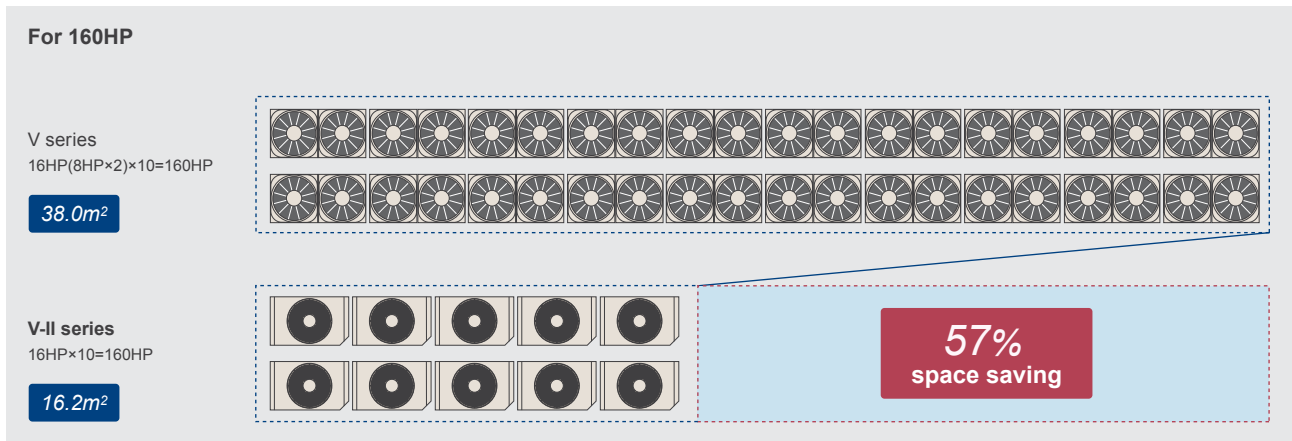
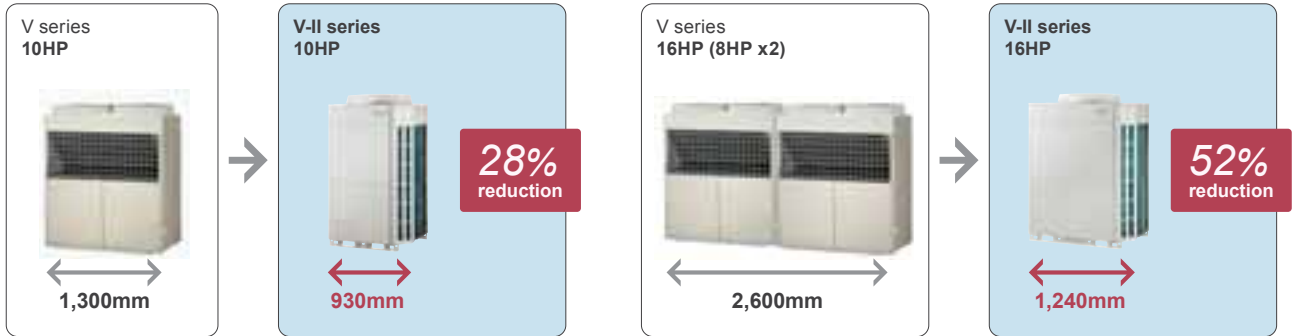

## High capacity connection

Various combination from 8HP to 48HP with 2HP increments. 11 types, 49 models of indoor units can be selected ranging from 2.2kW to 25kW in capacity. A maximum of 150% indoor unit connectable capacity.

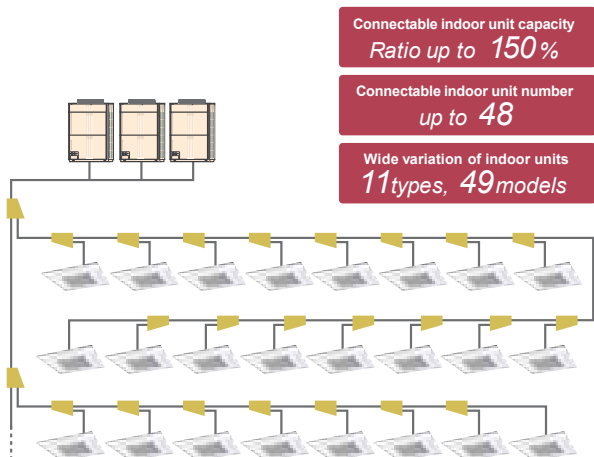

Note : when indoor unit connected capacity is greater than 100%, individual indoor units will operate at a slightly lower capacity when maximum capacity is required.

## Wide operating range

Installation in extreme temperature conditions is possible due to an increase in operational range.

Cooling : -15°C~46°C  
Heating : -20°C~21°C

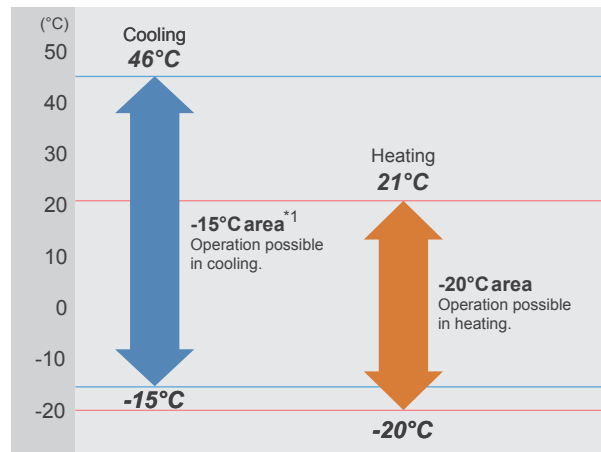

\*1 Note : When a multiple outdoor unit connection is used, operating range is from -5°C to 46°C in cooling.

## High Reliability

### Longer lasting units

#### Outdoor unit operation rotation

The compressor starting order is rotated so that the running time is shared.

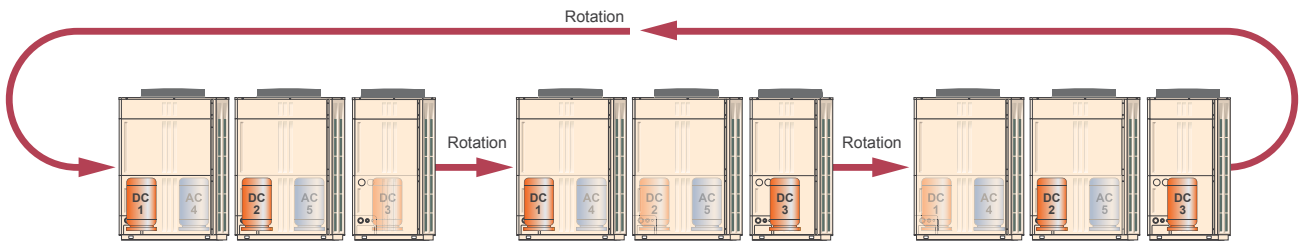

Note: The inverter compressors start in priority. Rotate operation is alternated by the start / stop timing of the compressors

### Continuous operation

If one of two compressors malfunctions, it will not affect the operation of the remaining outdoor units.

#### Outdoor Units

If one of compressors fails, emergency operation will be performed by the remaining compressors.

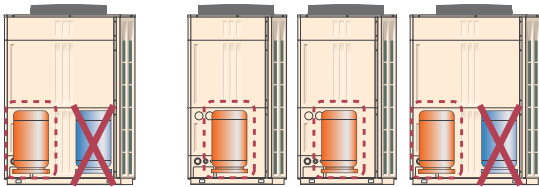

#### Indoor unit continuous operation

Each indoor unit is controlled individually on the system network. This allows all indoor units to continue to operate unaffected even if an error should occur at any indoor unit's on the VRF system.

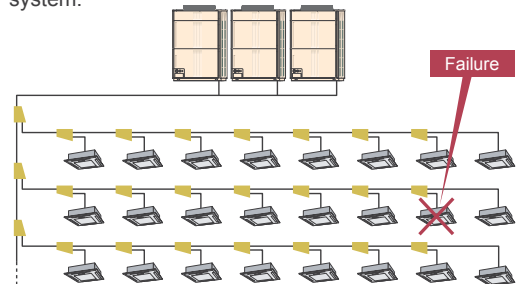

### Adoption of blue fin heat exchanger

Corrosion resistant of the heat exchanger has been improved by the introduction of blue fin treatment to the outdoor unit's heat exchanger.

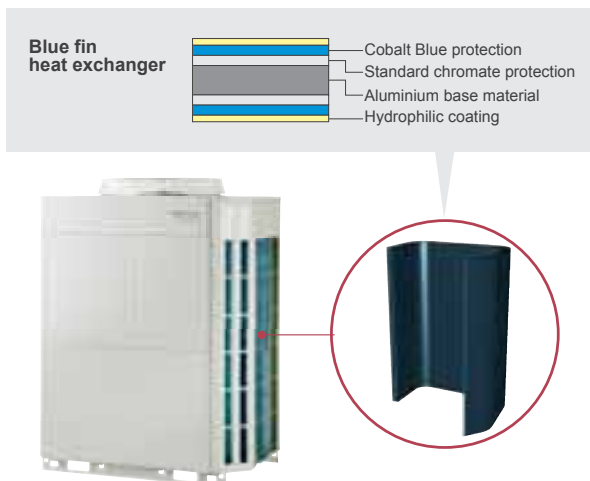

### Remote monitoring

The Web Monitoring system allows you view system operation at all times over the internet ensuring trouble free operation.

#### Monitoring Side



Internet or Public Telephone Line



#### VRF System Side

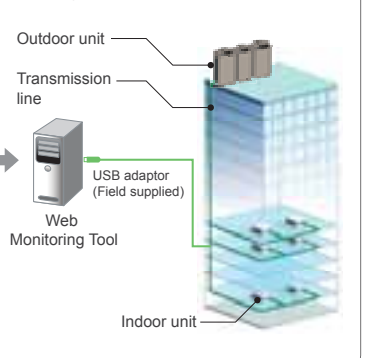

The operating VRF system in the building can be monitored in real time over the Internet.

# Easy Installation

## Easily transported

Light weight

**20%** weight reduction  
(Than Previous model)

Note:  
In the case of 14HP

Easily craned into position using lifting belt hooks

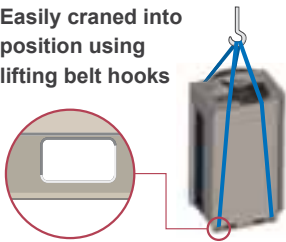

Design of outdoor unit allows for lifting straps to be used

Transporting by forklift

Can be transported in a small elevator



## Simple signal line connection

Installation is made easier as the communications wiring can be connected continuously to any component.

Up to maximum length **3,600m**

V-II series

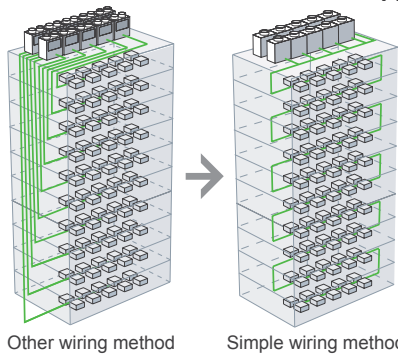

Note: In a multiple refrigerant system installation, Automatic addressing sequence cannot be initiated

## Easy access

By adopting a L-Shape front panel that can be removed, the work space for installation and service has been significantly expanded by this new design. For multiple installations, work is performed easily and efficiently even in a narrow space.



Expansion of work space

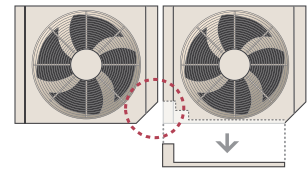

## Easy piping connection

The need for a oil equalization pipe as required on the previous model has been removed. The installation costs have been reduced by employing a simple 2 pipe connection

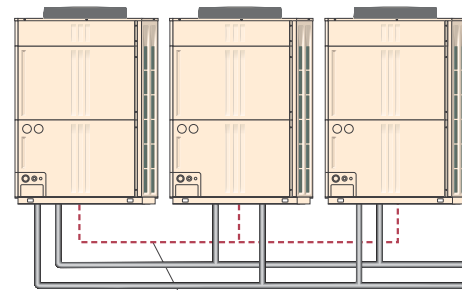

Eliminating oil equalization pipe

## Automatic address setting

The address of each indoor unit can be automatically set by button switch of outdoor unit.

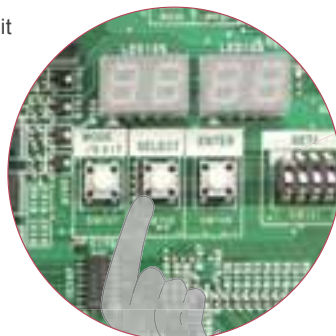

Press the pushbutton switch of outdoor unit.

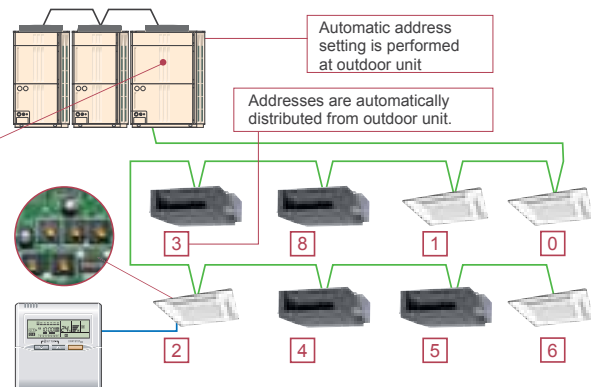

Manual address setting from indoor unit and remote controller is also possible.

## Comfort and Convenience

### Quiet operation

**Low noise mode:** Two low noise modes can be selected automatically by quiet priority setting and capacity priority setting depending on the usage environment and outside temperature load.

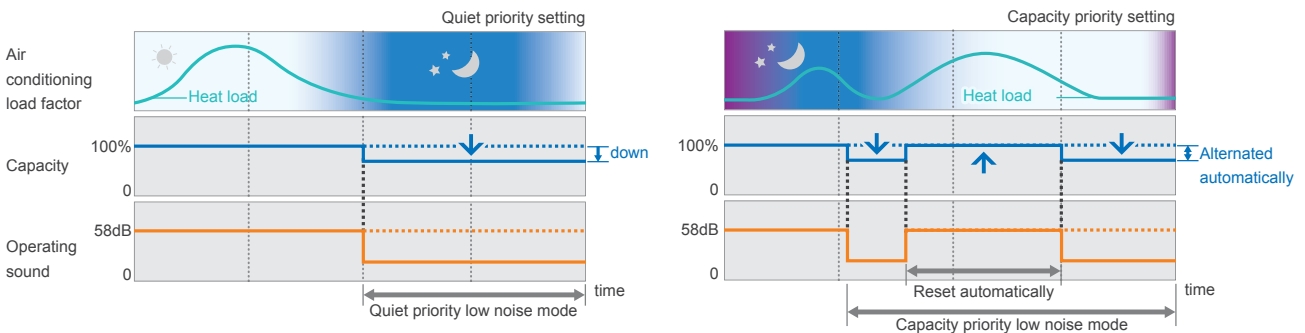

#### Low noise design:

Compressor noise has been significantly reduced by shielding the compressor compartment.



#### Indoor unit: Low noise indoor unit lineup



### Auto changeover function

Auto changeover setting allows for the product to easily switch between Cooling and heating modes regardless of the operation mode of other indoor units. This can be done via specific indoor unit remote controller and / or by an external input control. This ensures comfortable operation all year round.

Command for operational mode switching is controlled by one of the following options.

#### 1 selected from the following:

- 1 Various remote controllers connected to indoor unit
- 2 External input terminal of outdoor unit
- 3 System controller

Switching to cooling and heating mode by specific remote controller in the main room, etc.

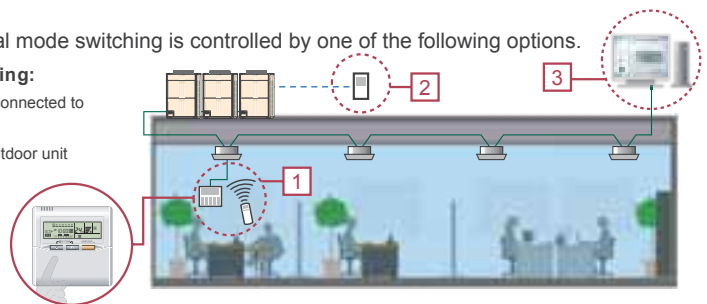

### Non-stop oil recovery operation

A comfortable room condition is maintained during oil recovery because the product continues to operate without stopping the cooling or heating operation.

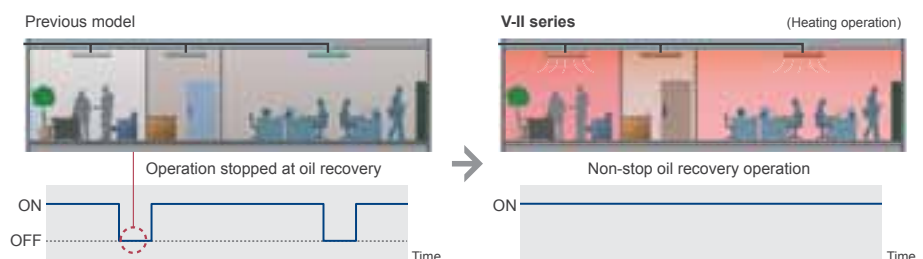

# Easy Service & Maintenance

## Design for easy service and maintenance

Inspection and replacement of main parts is easier due to innovative construction and an LED operational display.

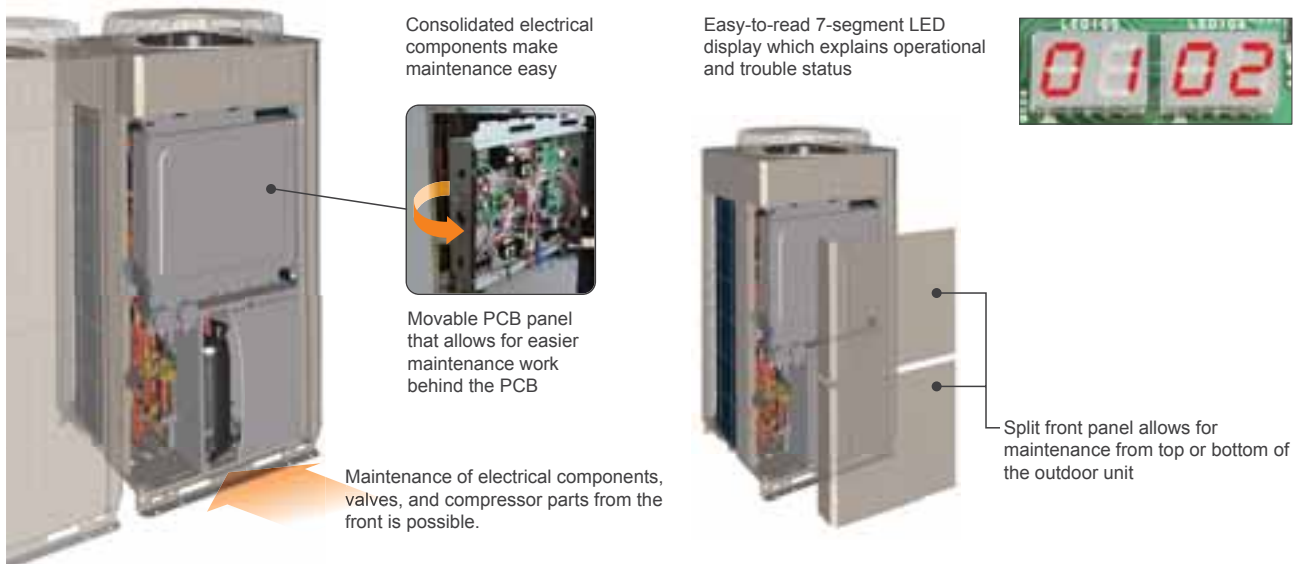

**Error status can be checked easily via the indoor unit wired controller**

An error code is displayed on a liquid crystal screen.

**Wired Remote Controller**

Faulty unit number (Remote controller address)

Error code

**Simple Remote Controller**

Faulty unit number (Remote controller address)

Error code

## Emergency stop function

Emergency alarm can be received by indoor, outdoor units or Touch Panel Controller when they received it, all units will be stopped.

Note:  
In case of received Emergency alarm by indoor/outdoor unit: All units connected within same refrigerant system will be stopped. Touch Panel Controller: all unit connected within VRF network system with Touch Panel Controller will be stopped.

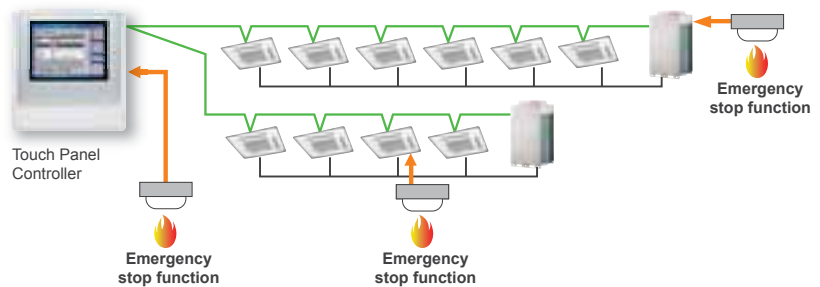





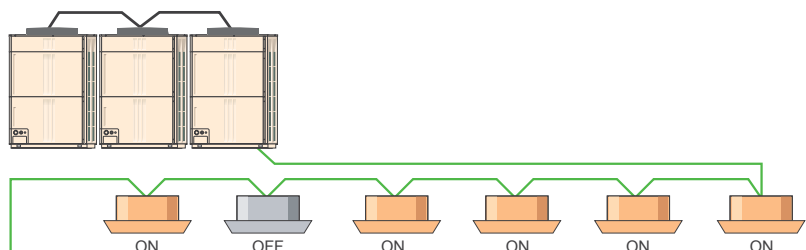















## Continuous operation during maintenance













**Non-stop operation:** When servicing a specific indoor unit, maintenance can be performed even without turning off the other indoor units.



## Outdoor units lineup **NEW**

•Combinations other than the followings are not recommended.

Space saving combination				
22.4kW (8HP)  AJYA72LALH UNIT : AJYA72LALH	28.0kW (10HP)  AJYA90LALH UNIT : AJYA90LALH	33.5kW (12HP)  AJY108LALH UNIT : AJY108LALH	40.0kW (14HP)  AJY126LALH UNIT : AJY126LALH	45.0kW (16HP)  AJY144LALH UNIT : AJY144LALH
50.4kW (18HP)  AJY162LALH UNIT : AJYA90/A72LALH	55.9kW (20HP)  AJY180LALH UNIT : AJY108/A72LALH	61.5kW (22HP)  AJY198LALH UNIT : AJY108/A90LALH	67.0kW (24HP)  AJY216LALH UNIT : AJY108/108LALH	73.5kW (26HP)  AJY234LALH UNIT : AJY126/108LALH
78.5kW (28HP)  AJY252LALH UNIT : AJY144/108LALH	85.0kW (30HP)  AJY270LALH UNIT : AJY144/126LALH	90.0kW (32HP)  AJY288LALH UNIT : AJY144/144LALH	95.0kW (34HP)  AJY306LALH UNIT : AJY108/108/A90LALH	100.5kW (36HP)  AJY324LALH UNIT : AJY108/108/108LALH
107.0kW (38HP)  AJY342LALH UNIT : AJY126/108/108LALH	112.0kW (40HP)  AJY360LALH UNIT : AJY144/108/108LALH	118.5kW (42HP)  AJY378LALH UNIT : AJY144/126/108LALH	123.5kW (44HP)  AJY396LALH UNIT : AJY144/144/108LALH	130.0kW (46HP)  AJY414LALH UNIT : AJY144/144/126LALH
135.0kW (48HP)  AJY432LALH UNIT : AJY144/144/144LALH				

Energy efficiency combination				
44.8kW (16HP)  AJY144LALHH UNIT : AJYA72/A72LALH	62.4kW (22HP)  AJY198LALHH UNIT : AJY126/A72LALH	67.2kW (24HP)  AJY216LALHH UNIT : AJYA72/A72/A72LALH	72.8kW (26HP)  AJY234LALHH UNIT : AJYA90/A72/A72LALH	78.3kW (28HP)  AJY252LALHH UNIT : AJY108/A72/A72LALH
84.8kW (30HP)  AJY270LALHH UNIT : AJY126/A72/A72LALH	89.8kW (32HP)  AJY288LALHH UNIT : AJY108/108/A72LALH	95.9kW (34HP)  AJY306LALHH UNIT : AJY126/108/A72LALH	102.4kW (36HP)  AJY324LALHH UNIT : AJY126/126/A72LALH	113.5kW (40HP)  AJY360LALHH UNIT : AJY126/126/A108LALH
120.0kW (42HP)  AJY378LALHH UNIT : AJY126/126/126LALH	125.0kW (44HP)  AJY396LALHH UNIT : AJY144/126/126LALH			



# Outdoor units dimensions

## Dimensions

(Unit : mm)

8,10,12HP: AJYA72LALH / AJYA90LALH / AJY108LALH

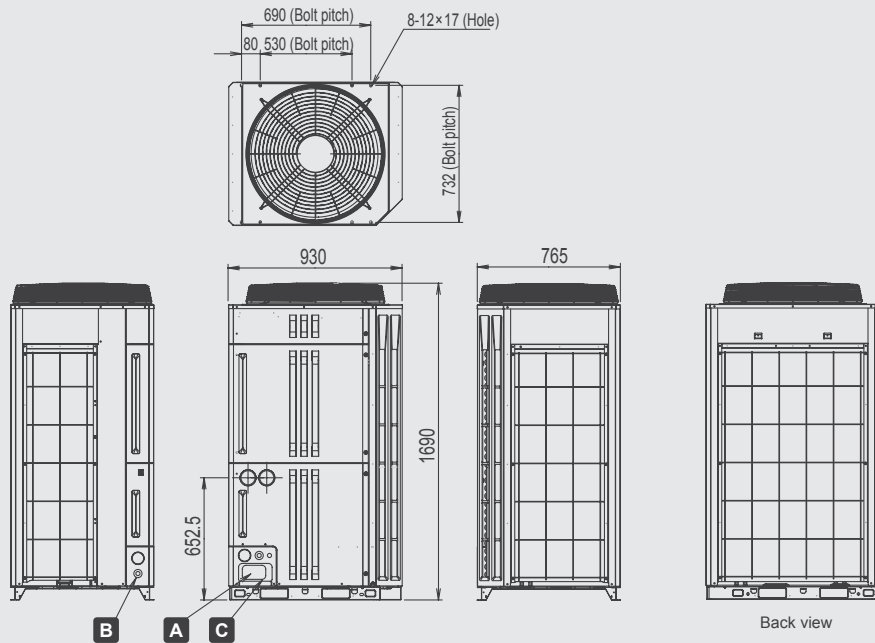



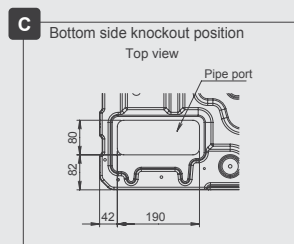
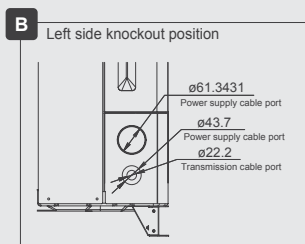
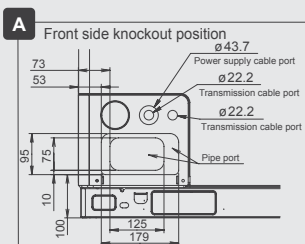
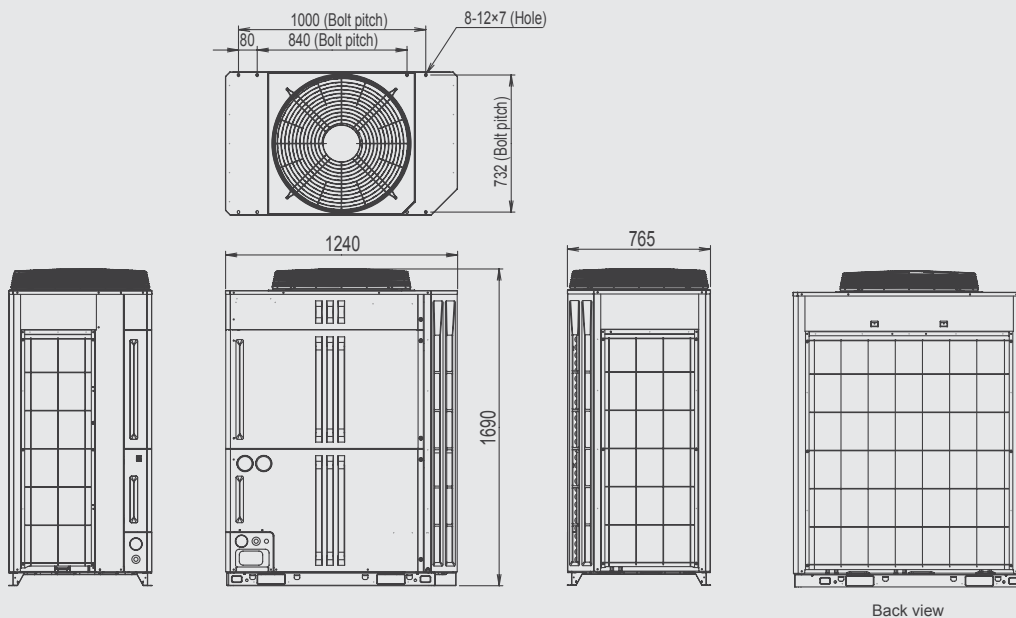

14,16HP: AJY126LALH / AJY144LALH









## Outdoor units specifications

### Space Saving Combination











Rating Capacity range		HP	8	10	12	14	16	18	20	22	24
											
Model name			AJYA72LALH	AJYA90LALH	AJY108LALH	AJY126LALH	AJY144LALH	AJY162LALH	AJY180LALH	AJY198LALH	AJY216LALH
Unit 1			AJYA72LALH	AJYA90LALH	AJY108LALH	AJY126LALH	AJY144LALH	AJYA90LALH	AJY108LALH	AJY108LALH	AJY108LALH
Unit 2								AJYA72LALH	AJYA72LALH	AJYA90LALH	AJY108LALH
Unit 3											
Maximum Connectable Indoor Unit*1			15	16	17	21	24	32	32	32	35
Indoor unit connectable capacity		Cooling	11.2-33.6	14.0-42.0	16.8-50.2	20.0-60.0	22.4-67.2	25.2-75.6	28.0-83.9	30.8-92.3	33.5-100.5
Power source			3-phase 4 wire, 400 V, 50Hz								
Capacity		Cooling	22.4	28.0	33.5	40.0	45.0	50.4	55.9	61.5	67.0
		Heating	25.0	31.5	37.5	45.0	50.0	56.5	62.5	69.0	75.0
Input power		Cooling	5.51	7.73	9.62	11.53	14.17	13.24	15.13	17.35	19.24
		Heating	5.72	7.83	9.28	11.45	12.60	13.55	15.00	17.11	18.56
EER		Cooling	4.07	3.62	3.48	3.47	3.18	3.81	3.69	3.54	3.48
COP		Heating	4.37	4.02	4.04	3.93	3.97	4.17	4.17	4.03	4.04
Air flow rate		High	11,100	11,100	11,100	13,000	13,000	11,100 x 2	11,100 x 2	11,100 x 2	11,100 x 2
Sound pressure level*2		Cooling	56	58	58	60	61	60	60	61	61
		Heating	58	59	60	61	61	62	62	63	63
Maximum external static pressure		Pa	80	80	80	80	80	80	80	80	80
Compressor motor output		kW	3.9	3.9	3.9 + 4.5	3.9 + 4.5	3.9 + 4.5	3.9 x 2	3.9 x 2 + 4.5	3.9 x 2 + 4.5	3.9 x 2 + 4.5 x 2
Heat exchanger fin			Blue fin	Blue fin	Blue fin	Blue fin	Blue fin	Blue fin	Blue fin	Blue fin	Blue fin
Dimensions		Height	mm	1,690	1,690	1,690	1,690	1,690	1,690	1,690	1,690
		Width	mm	930	930	930	1,240	1,240	930 x 2	930 x 2	930 x 2
		Depth	mm	765	765	765	765	765	765	765	765
Weight		kg	220	220	275	296	296	220 + 220	275 + 220	275 + 220	275 + 275
Refrigerant charge		kg	11.2	11.2	11.8	11.8	11.8	11.2 x 2	11.8 + 11.2	11.8 + 11.2	11.8 x 2
Connection pipe diameter		Liquid	mm	12.70	12.70	12.70	12.70	12.70	15.88	15.88	15.88
		Gas	mm	22.20	22.20	28.58	28.58	28.58	28.58	34.92	34.92
Operation range		Cooling	°C	-15 to 46	-15 to 46	-15 to 46	-15 to 46	-15 to 46	-5 to 46	-5 to 46	-5 to 46
		Heating	°C	-20 to 21	-20 to 21	-20 to 21	-20 to 21	-20 to 21	-20 to 21	-20 to 21	-20 to 21







### Energy Efficiency Combination

Rating Capacity range		HP	16	22	24	26	28	30
								
Model name			AJY144LALHH	AJY198LALHH	AJY216LALHH	AJY234LALHH	AJY252LALHH	AJY270LALHH
Unit 1			AJYA72LALH	AJY126LALH	AJYA72LALH	AJYA90LALH	AJY108LALH	AJY126LALH
Unit 2			AJYA72LALH	AJYA72LALH	AJYA72LALH	AJYA72LALH	AJYA72LALH	AJYA72LALH
Unit 3								
Maximum Connectable Indoor Unit*1			30	33	36	39	42	45
Indoor unit connectable capacity		Cooling	22.4-67.2	31.2-93.6	33.6-100.8	36.4-109.2	39.2-117.4	42.4-127.2
Power source			3-phase 4 wire, 400 V, 50Hz					
Capacity		Cooling	44.8	62.4	67.2	72.8	78.3	84.8
		Heating	50.0	70.0	75.0	81.5	87.5	95.0
Input power		Cooling	11.02	17.04	16.53	18.75	20.64	22.55
		Heating	11.44	17.17	17.16	19.27	20.72	22.89
EER		Cooling	4.07	3.66	4.07	3.88	3.79	3.76
COP		Heating	4.37	4.08	4.37	4.23	4.22	4.15
Air flow rate		High	m³/h	11,100 x 2	13,000 + 11,100	11,100 x 3	11,100 x 3	11,100 x 3
Sound pressure level*2		Cooling	59	61	61	62	62	63
		Heating	59	62	61	62	63	63
Maximum external static pressure		Pa	80	80	80	80	80	80
Compressor motor output		kW	3.9 x 2	3.9 x 2 + 4.5	3.9 x 3	3.9 x 3	3.9 x 3 + 4.5	3.9 x 3 + 4.5
Heat exchanger fin			Blue fin	Blue fin	Blue fin	Blue fin	Blue fin	Blue fin
Dimensions		Height	mm	1,690	1,690	1,690	1,690	1,690
		Width	mm	930 x 2	930 + 1,240	930 x 3	930 x 3	930 x 3
		Depth	mm	765	765	765	765	765
Weight		kg	220 + 220	296 + 220	220 + 220 + 220	220 + 220 + 220	275 + 220 + 220	296 + 220 + 220
Refrigerant charge		kg	11.2 x 2	11.8 + 11.2	11.2 x 3	11.2 x 3	11.8 + 11.2 x 2	11.8 + 11.2 x 2
Connection pipe diameter		Liquid	mm	12.70	15.88	15.88	15.88	19.05
		Gas	mm	28.58	34.92	34.92	34.92	34.92
Operation range		Cooling	°C	-5 to 46	-5 to 46	-5 to 46	-5 to 46	-5 to 46
		Heating	°C	-20 to 21	-20 to 21	-20 to 21	-20 to 21	-20 to 21

Note : Specifications are based on the following conditions.  
 Cooling : Indoor temperature of 27°CDB / 19°CWB, and outdoor temperature of 35°CDB / 24°CWB.  
 Heating : Indoor temperature of 20°CDB / (15°CWB), and outdoor temperature of 7°CDB / 6°CWB.

Pipe length : 7.5 m; Height difference between outdoor unit and indoor unit : 0 m.  
 When cooling operation will be conducted at outdoor air temperature below -5°C, the outdoor unit must be installed in a position that is higher than or equal to those of indoor units.

26	28	30	32	34	36	38	40	42	44	46	48
											
AJY234LALH	AJY252LALH	AJY270LALH	AJY288LALH	AJY306LALH	AJY324LALH	AJY342LALH	AJY360LALH	AJY378LALH	AJY396LALH	AJY414LALH	AJY432LALH
AJY126LALH	AJY144LALH	AJY144LALH	AJY144LALH	AJY108LALH	AJY108LALH	AJY126LALH	AJY144LALH	AJY144LALH	AJY144LALH	AJY144LALH	AJY144LALH
AJY108LALH	AJY108LALH	AJY126LALH	AJY144LALH	AJY108LALH	AJY108LALH	AJY108LALH	AJY108LALH	AJY108LALH	AJY108LALH	AJY108LALH	AJY144LALH
39	42	45	48	48	48	48	48	48	48	48	48
36.8-110.3	39.3-117.8	42.5-127.5	45.0-135.0	47.5-142.5	50.3-150.8	53.5-160.5	56.0-168.0	59.3-177.8	61.8-185.3	65.0-195.0	67.5-202.5
3-phase 4 wire, 400 V, 50Hz											
73.5	78.5	85.0	90.0	95.0	100.5	107.0	112.0	118.5	123.5	130.0	135.0
82.5	87.5	95.0	100.0	106.5	112.5	120.0	125.0	132.5	137.5	145.0	150.0
21.15	23.79	25.70	28.34	26.97	28.86	30.77	33.41	35.32	37.96	39.87	42.51
20.73	21.88	24.05	25.20	26.39	27.84	30.01	31.16	33.33	34.48	36.65	37.80
3.48	3.30	3.31	3.18	3.52	3.48	3.48	3.35	3.36	3.25	3.26	3.18
3.98	4.00	3.95	3.97	4.04	4.04	4.00	4.01	3.98	3.99	3.96	3.97
13,000 + 11,100	13,000 + 11,100	13,000 x 2	13,000 x 2	11,100 x 3	11,100 x 3	13,000 + 11,100 x 2	13,000 + 11,100 x 2	13,000 x 2 + 11,100	13,000 x 2 + 11,100	13,000 x 3	13,000 x 3
62	63	64	64	63	63	64	64	65	65	65	66
64	64	64	64	64	65	65	65	65	65	66	66
80	80	80	80	80	80	80	80	80	80	80	80
3.9 x 2 + 4.5 x 2	3.9 x 2 + 4.5 x 2	3.9 x 2 + 4.5 x 2	3.9 x 2 + 4.5 x 2	3.9 x 3 + 4.5 x 2	3.9 x 3 + 4.5 x 3	3.9 x 3 + 4.5 x 3	3.9 x 3 + 4.5 x 3	3.9 x 3 + 4.5 x 3	3.9 x 3 + 4.5 x 3	3.9 x 3 + 4.5 x 3	3.9 x 3 + 4.5 x 3
Blue fin	Blue fin	Blue fin	Blue fin	Blue fin	Blue fin	Blue fin	Blue fin	Blue fin	Blue fin	Blue fin	Blue fin
1,690	1,690	1,690	1,690	1,690	1,690	1,690	1,690	1,690	1,690	1,690	1,690
930 + 1,240	930 + 1,240	1,240 x 2	1,240 x 2	930 x 3	930 x 3	930 x 2 + 1,240	930 x 2 + 1,240	930 + 1,240 x 2	930 + 1,240 x 2	1,240 x 3	1,240 x 3
765	765	765	765	765	765	765	765	765	765	765	765
296 + 275	296 + 275	296 + 296	296 + 296	275 + 275 + 220	275 + 275 + 275	296 + 275 + 275	296 + 275 + 275	296 + 296 + 275	296 + 296 + 275	296 + 296 + 296	296 + 296 + 296
11.8 x 2	11.8 x 2	11.8 x 2	11.8 x 2	11.8 x 2 + 11.2	11.8 x 3	11.8 x 3	11.8 x 3	11.8 x 3	11.8 x 3	11.8 x 3	11.8 x 3
15.88	15.88	19.05	19.05	19.05	19.05	19.05	19.05	19.05	19.05	19.05	19.05
34.92	34.92	34.92	34.92	34.92	41.27	41.27	41.27	41.27	41.27	41.27	41.27
-5 to 46	-5 to 46	-5 to 46	-5 to 46	-5 to 46	-5 to 46	-5 to 46	-5 to 46	-5 to 46	-5 to 46	-5 to 46	-5 to 46
-20 to 21	-20 to 21	-20 to 21	-20 to 21	-20 to 21	-20 to 21	-20 to 21	-20 to 21	-20 to 21	-20 to 21	-20 to 21	-20 to 21

32	34	36	40	42	44
					
AJY288LALHH	AJY306LALHH	AJY324LALHH	AJY360LALHH	AJY378LALHH	AJY396LALHH
AJY108LALH	AJY126LALH	AJY126LALH	AJY126LALH	AJY126LALH	AJY144LALH
AJY108LALH	AJY108LALH	AJY126LALH	AJY126LALH	AJY126LALH	AJY126LALH
AJYA72LALH	AJYA72LALH	AJYA72LALH	AJYA108LALH	AJY126LALH	AJY126LALH
48	48	48	48	48	48
44.7-134.1	48.0-143.8	51.2-153.6	56.8-170.2	60.0-180.0	62.5-187.5
3-phase 4 wire, 400 V, 50Hz					
89.4	95.9	102.4	113.5	120.0	125.0
100.0	107.5	115.0	127.5	135.0	140.0
24.75	26.66	28.57	32.68	34.59	37.23
24.28	26.45	28.62	32.18	34.35	35.50
3.61	3.60	3.58	3.47	3.47	3.36
4.12	4.06	4.02	3.96	3.93	3.94
11,100 x 3	13,000 + 11,100 x 2	13,000 x 2 + 11,100	13,000 x 2 + 11,100	13,000 x 3	13,000 x 3
62	63	64	64	65	65
64	64	65	65	66	66
80	80	80	80	80	80
3.9 x 3 + 4.5 x 2	3.9 x 3 + 4.5 x 2	3.9 x 3 + 4.5 x 2	3.9 x 3 + 4.5 x 3	3.9 x 3 + 4.5 x 3	3.9 x 3 + 4.5 x 3
Blue fin	Blue fin	Blue fin	Blue fin	Blue fin	Blue fin
1,690	1,690	1,690	1,690	1,690	1,690
930 x 3	930 x 2 + 1,240	930 + 1,240 x 2	930 + 1,240 x 2	1,240 x 3	1,240 x 3
765	765	765	765	765	765
275 + 275 + 220	296 + 275 + 220	296 + 296 + 220	296 + 296 + 275	296 + 296 + 296	296 + 296 + 296
11.8 x 2 + 11.2	11.8 x 2 + 11.2	11.8 x 2 + 11.2	11.8 x 3	11.8 x 3	11.8 x 3
19.05	19.05	19.05	19.05	19.05	19.05
34.92	34.92	41.27	41.27	41.27	41.27
-5 to 46	-5 to 46	-5 to 46	-5 to 46	-5 to 46	-5 to 46
-20 to 21	-20 to 21	-20 to 21	-20 to 21	-20 to 21	-20 to 21

\*1 Minimum connectable indoor unit number is 2.

















However ARXC72 and ARXC90 can be used signal connection.



\*2 The noise value is the value when measured in an anechoic room.

When measured in the actual installed state, surrounding noise and reflections are received and the measured value is usually larger than the indicated value.

\*: Data were not available at time of publication.

## Indoor units lineup **NEW**

Capacity range (kW)	2.20	2.80	3.60	4.50	5.60	
Model code	7	9	12	14	18	
<b>Compact Cassette</b>	 AUXB07LALH	 AUXB09LALH	 AUXB12LALH	 AUXB14LALH	 AUXB18LALH	
<b>Cassette</b>					 AUXD18LALH	
<b>Compact Duct</b>	 ARXB07LALH	 ARXB09LALH	 ARXB12LALH	 ARXB14LALH	 ARXB18LALH	
<b>Low Static Pressure Duct</b>						
<b>Duct</b>						
<b>High Static Pressure Duct</b>						
<b>Floor / Ceiling</b>			 ABYA12LATH	 ABYA14LATH	 ABYA18LATH	
<b>Ceiling</b>						
<b>Compact Wall Mounted (EEV internal)</b>	 ASYA07LACH	 ASYA09LACH	 ASYA12LACH	 ASYA14LACH		
<b>Compact Wall Mounted (EEV external)</b>	 ASYE07LACH	 ASYE09LACH	 ASYE12LACH	 ASYE14LACH		
With this model, connection of EV kit is necessary.						
<b>Wall Mounted</b>				 ASYA18LATH	 ASYA24LATH	

	7.10 24	9.00 30	11.2 36	12.5 45	14.0 54	18.0 60	22.4 72	25.0 90
 AUXB24LALH								
 AUXD24LALH	 AUXA30LALH	 AUXA36LALH	 AUXA45LALH	 AUXA54LALH				
 ARXB24LATH	 ARXB30LATH	 ARXB36LATH	 ARXB45LATH					
 ARXA24LATH	 ARXA30LATH	 ARXA36LATH	 ARXA45LATH					
			 ARXC36LATH	 ARXC45LATH		 ARXC60LATH	 ARXC72LATH	 ARXC90LATH
 ABYA24LATH								
	 ABYA30LATH	 ABYA36LATH	 ABYA45LATH	 ABYA54LATH				
 ASYA30LATH								

## Indoor units specifications

### Compact Cassette



Model name		AUXB07LALH	AUXB09LALH	AUXB12LALH	AUXB14LALH	AUXB18LALH	AUXB24LALH
Power source		230V~, 50Hz					
Capacity	Cooling	2.2	2.8	3.6	4.5	5.6	7.1
	Heating	2.8	3.2	4.1	5.0	6.3	8.0
Input power		25	25	29	35	36	84
Airflow rate	High	540	550	600	680	710	1,030
	Med	450	450	530	590	580	830
	Low	350	350	390	390	400	450
Sound pressure level	High	34	35	37	38	41	50
	Med	30	30	34	34	35	44
	Low	25	25	27	27	27	30
Dimensions (H x W x D)		mm 245 x 570 x 570					
Weight		kg 15					kg 17
Connection pipe diameter	Liquid (Flare)	mm ø6.35				mm ø9.52	
	Gas (Flare)	mm ø12.70				mm ø15.88	
	Drain	mm ø25 (I.D.); ø32 (O.D.)					
Grille(option)	Model name	UTG-UFYC-W					
	Dimensions (H x W x D)	mm 50 x 700 x 700					
	Weight	kg 2.6					

Note : Specifications are based on the following conditions.

Cooling : Indoor temperature of 27°CDB / 19°CWB, and outdoor temperature of 35°CDB / 24°CWB.

Heating : Indoor temperature of 20°CDB / (15°CWB), and outdoor temperature of 7°CDB / 6°CWB.

Pipe length : 7.5 m; Height difference between outdoor unit and indoor unit : 0 m.

Voltage : 230 [V].

### Cassette

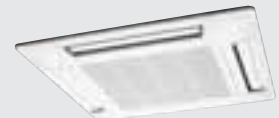

Model name		AUXD18LALH	AUXD24LALH	AUXA30LALH	AUXA36LALH	AUXA45LALH	AUXA54LALH	
Power source		230V~, 50Hz						
Capacity	Cooling	5.6	7.1	9.0	11.2	12.5	14.0	
	Heating	6.3	8.0	10.0	12.5	14.0	16.0	
Input power		39	46	59	80	99	119	
Airflow rate	High	1,150	1,280	1,600	1,800	1,900	2,000	
	Med	940	1,040	1,300	1,300	1,370	1,370	
	Low	870	870	1,000	1,000	1,000	1,000	
Sound pressure level	High	36	38	40	44	46	47	
	Med	30	33	38	38	39	39	
	Low	29	29	31	31	31	31	
Dimensions (H x W x D)		mm 246 x 840 x 840			mm 288 x 840 x 840			
Weight		kg 23			kg 27			
Connection pipe diameter	Liquid (Flare)	mm ø9.52				mm ø19.05		
	Gas (Flare)	mm ø15.88				mm ø19.05		
	Drain	mm ø25 (I.D.); ø32 (O.D.)						
Grille(option)	Model name	UTG-UGYA-W						
	Dimensions (H x W x D)	mm 50 x 950 x 950						
	Weight	kg 5.5						

Note : Specifications are based on the following conditions.

Cooling : Indoor temperature of 27°CDB / 19°CWB, and outdoor temperature of 35°CDB / 24°CWB.

Heating : Indoor temperature of 20°CDB / (15°CWB), and outdoor temperature of 7°CDB / 6°CWB.

Pipe length : 7.5 m; Height difference between outdoor unit and indoor unit : 0 m.

Voltage : 230 [V].

## Compact Duct Low Static Duct Duct



Model name		ARXB07 LALH	ARXB09 LALH	ARXB12 LALH	ARXB14 LALH	ARXB18 LALH	ARXB24 LATH	ARXB30 LATH	ARXB36 LATH	ARXB45 LATH	ARXA24 LATH	ARXA30 LATH	ARXA36 LATH	ARXA45 LATH	
Power source		230V~, 50Hz													
Capacity	Cooling	2.2	2.8	3.6	4.5	5.6	7.1	9.0	11.2	12.5	7.1	9.0	11.2	12.5	
	Heating	2.8	3.2	4.1	5.0	6.3	8.0	10.0	12.5	14.0	8.0	10.0	12.5	14.0	
Input power		46	55	63	90	96	145	198	253	338	190	188	312	312	
Airflow rate	High	370	440	590	800	890	1,100	1,410	1,710	1,970	1,280	1,280	1,720	1,720	
	Med	310	370	500	750	810	920	1,280	1,600	1,790	1,210	1,210	1,670	1,670	
	Low	280	340	450	700	730	810	1,150	1,470	1,670	1,130	1,130	1,600	1,600	
Static pressure range		0 to 50	0 to 50	0 to 50	0 to 50	0 to 50	0 to 80	0 to 80	0 to 80	0 to 80	30 to 150	30 to 150	30 to 150	30 to 150	
Standard static pressure		25	25	25	25	25	40	50	60	60	100	100	100	100	
Sound pressure level	High	29	31	30	33	36	31	34	37	41	38	40	43	43	
	Med	26	29	28	32	34	27	32	35	38	36	38	41	41	
	Low	24	27	25	30	30	25	29	33	36	34	36	39	39	
Dimensions (H x W x D)		217 x 663 x 595		217 x 953 x 595			270x1,135x700			270x1,135x700					
Weight		18		25			43	45			43	45			
Connection pipe diameter	Liquid (Flare)	ø6.35			ø9.52		ø9.52			ø9.52					
	Gas (Flare)	ø12.70			ø15.88		ø15.88		ø19.05		ø15.88		ø19.05		
	Drain	ø25 (I.D.) ; ø32 (O.D.)					ø25 (I.D.) ; ø32 (O.D.)			ø25 (I.D.) ; ø32 (O.D.)					

Note : Specifications are based on the following conditions.

Cooling : Indoor temperature of 27°CDB / 19°CWB, and outdoor temperature of 35°CDB / 24°CWB.

Heating : Indoor temperature of 20°CDB / (15°CWB), and outdoor temperature of 7°CDB / 6°CWB.

Pipe length : 7.5 m; Height difference between outdoor unit and indoor unit : 0 m.

## High Static Pressure Duct



Model name		ARXC36LATH	ARXC45LATH	ARXC60LATH	ARXC72LATH	ARXC90LATH	
Power source		230V~, 50Hz					
Capacity	Cooling	11.2	12.5	18.0	22.4	25.0	
	Heating	12.5	14.0	20.0	25.0	28.0	
Input power		405	427	427	1,110	1,250	
Airflow rate	High	2,600	3,500	3,500	3,900	4,300	
	Med	1,950	3,000	3,000	3,300	4,000	
	Low	1,450	2,460	2,460	3,000	3,500	
Static pressure range		100 to 200	100 to 250	100 to 250	50 to 300	100 to 300	
Standard static pressure		100	100	100	260	250	
Sound pressure level	High	45	49	49	51	53	
	Med	38	45	45	48	51	
	Low	32	42	42	45	49	
Dimensions (H x W x D)		400 x 1,050 x 500			450 x 1,550 x 700		
Weight		45	47		82	85	
Connection pipe diameter	Liquid	ø9.52 (Flare)			ø12.70 (Brazing)		
	Gas (Flare)	ø19.05 (Flare)			ø22.22 (Brazing)		
	Drain	ø25 (I.D.) ; ø32 (O.D.)					

Note : Specifications are based on the following conditions.

Cooling : Indoor temperature of 27°CDB / 19°CWB, and outdoor temperature of 35°CDB / 24°CWB.

Heating : Indoor temperature of 20°CDB / (15°CWB), and outdoor temperature of 7°CDB / 6°CWB.

Pipe length : 7.5 m; Height difference between outdoor unit and indoor unit : 0 m.



## Indoor units specifications

### Floor / Ceiling



Model name			ABYA12LATH	ABYA14LATH	ABYA18LATH	ABYA24LATH
Power source			230V~ , 50Hz			
Capacity	Cooling	kW	3.6	4.0	5.6	7.1
	Heating		4.1	4.5	6.3	8.0
Input power		W	57	57	88	88
Airflow rate	High	m³/h	600	600	780	880
	Med		500	500	650	740
	Low		480	480	550	630
Sound pressure level	High	dB(A)	40	40	46	48
	Med		37	37	41.5	44
	Low		34	34	37	40
Dimensions (H x W x D)		mm	199 x 990 x 655			
Weight		kg	28			
Connection pipe diameter	Liquid (Flare)	mm	ø6.35		ø9.52	
	Gas (Flare)		ø12.70		ø15.88	
	Drain		ø25 (I.D.) ; ø32 (O.D.)			

Note : Specifications are based on the following conditions.

Cooling : Indoor temperature of 27°CDB / 19°CWB, and outdoor temperature of 35°CDB / 24°CWB.

Heating : Indoor temperature of 20°CDB / (15°CWB), and outdoor temperature of 7°CDB / 6°CWB.

Pipe length : 7.5 m; Height difference between outdoor unit and indoor unit : 0 m.

Voltage : 230 [V].

### Ceiling



Model name			ABYA30LATH	ABYA36LATH	ABYA45LATH	ABYA54LATH
Power source			230V~ , 50Hz			
Capacity	Cooling	kW	9.0	11.2	12.5	14.0
	Heating		10.0	12.5	14.0	16.0
Input power		W	124	144	160	180
Airflow rate	High	m³/h	1,450	1,660	1,850	2,200
	Med		1,280	1,500	1,660	2,000
	Low		980	1,270	1,430	1,800
Sound pressure level	High	dB(A)	42	45	48	52
	Med		39	42	46	50
	Low		35	37	41	46
Dimensions (H x W x D)		mm	240 x 1,660 x 700			
Weight		kg	48			
Connection pipe diameter	Liquid (Flare)	mm	ø15.88		ø19.05	
	Gas (Flare)		ø15.88		ø19.05	
	Drain		ø25 (I.D.) ; ø32 (O.D.)			

Note : Specifications are based on the following conditions.

Cooling : Indoor temperature of 27°CDB / 19°CWB, and outdoor temperature of 35°CDB / 24°CWB.

Heating : Indoor temperature of 20°CDB / (15°CWB), and outdoor temperature of 7°CDB / 6°CWB.

Pipe length : 7.5 m; Height difference between outdoor unit and indoor unit : 0 m.

Voltage : 230 [V].

## Compact Wall Mounted



Model name			ASYA07LACH	ASYA09LACH	ASYA12LACH	ASYA14LACH	ASYE07LACH	ASYE09LACH	ASYE12LACH	ASYE14LACH
Power source			230V~, 50Hz				230V~, 50Hz			
Capacity	Cooling	kW	2.2	2.8	3.6	4.5	2.2	2.8	3.6	4.5
	Heating		2.8	3.2	4.1	5.0	2.8	3.2	4.1	5.0
Input power			16	16	19	30	15	16	20	28
Airflow rate	High	m <sup>3</sup> /h	490	500	560	670	490	500	560	680
	Med		450	450	480	490	450	450	480	490
	Low		370	370	420	420	370	370	420	420
Sound pressure level	High	dB(A)	35	36	39	44	34	35	38	43
	Med		33	33	35	37	32	32	34	35
	Low		27	27	31	32	26	26	30	30
Dimensions (H x W x D)			275 x 790 x 215				275 x 790 x 215			
Weight			9				9			
Connection pipe diameter	Liquid (Flare)	mm	ø6.35				ø6.35			
	Gas (Flare)		ø12.70				ø12.70			
	Drain		ø13.8(I.D.) ; ø15.8-ø16.7(O.D.)				ø13.8(I.D.) ; ø15.8-ø16.7(O.D.)			
EV Kit (option)							UTR-EV09XB		UTR-EV14XB	

Note : Specifications are based on the following conditions.

Cooling : Indoor temperature of 27°CDB / 19°CWB, and outdoor temperature of 35°CDB / 24°CWB.

Heating : Indoor temperature of 20°CDB / (15°CWB), and outdoor temperature of 7°CDB / 6°CWB.

Pipe length : 7.5 m; Height difference between outdoor unit and indoor unit : 0 m.

Voltage : 230 [V].

## Wall Mounted



Model name			ASYA18LATH	ASYA24LATH	ASYA30LATH
Power source			230V~, 50Hz		
Capacity	Cooling	kW	5.6	7.1	8.0
	Heating		6.3	8.0	8.8
Input power			63	74	73
Airflow rate	High	m <sup>3</sup> /h	870	940	980
	Med		700	720	870
	Low		540	600	750
Sound pressure level	High	dB(A)	43	45	45
	Med		37	39	42
	Low		30	33	39
Dimensions (H x W x D)			320 x 1,120 x 220		
Weight			16		
Connection pipe diameter	Liquid (Flare)	mm	ø9.52		
	Gas (Flare)		ø15.88		
	Drain		ø12 (I.D.) ; ø16 (O.D.)		

Note : Specifications are based on the following conditions.



Cooling : Indoor temperature of 27°CDB / 19°CWB, and outdoor temperature of 35°CDB / 24°CWB.

Heating : Indoor temperature of 20°CDB / (15°CWB), and outdoor temperature of 7°CDB / 6°CWB.









Pipe length : 7.5 m; Height difference between outdoor unit and indoor unit : 0 m.

Voltage : 230 [V].

# Control Systems Lineup

Type			Split	Multi	VRF			
					J	S	V	V-II
Individual control system	Wired Remote Controller		● UTB-YUD	● UTB-YUD	● UTB-YUB	● UTB-YUB	● UTB-YUB	● UTY-RNKY
	Simple Remote Controller		● UTB-YPB	● UTB-YPB	● UTB-YPB	● UTB-YPB	● UTB-YPB	● UTY-RSKY
	Simple Remote Controller (Without master control)		—	—	● UTB-YRA	● UTB-YRA	● UTB-YRA	● UTY-RHKY
	Wireless Remote Controller		● UTB-YNA	● UTB-YNA	Accessory	● UTB-YVB	● UTB-YVB	● UTY-LNHY
	IR Receiver Unit		● UTY-LRH1	● UTY-LRH1	Accessory	● UTB-YWA	● UTB-YWA	● UTB-YWB
	IR Receiver Kit		● UTY-LRH1 With wireless remote controller	● UTY-LRH1 With wireless remote controller	—	—	—	● UTY-LRH1
Centralized control system	Group Remote Controller		—	—	● UTB-YDB	● UTB-YDB	● UTB-YDB	● UTY-CGGY
	Central Remote Controller		—	—	—	● UTB-YCA	● UTB-YCA	—
	Touch panel Controller		—	—	—	—	—	● UTY-DTGY
	System Controller		—	—	—	● UTY-APGX	● UTY-APGX	● UTY-APGX
Adaptor & Converter	Transmission Adaptor		—	—	—	● UTR-YTMA UTR-YTMB	● UTR-YTMA UTR-YTMB	—
	Network Converter		—	—	● UTR-YGCA	● UTR-YRDA	● UTR-YRDA	● UTY-VGGX
	Network Converter for LONWORKS®		—	—	—	● UTR-YLLA	● UTR-YLLA	● UTY-VLGX
	BACnet® Gateway		—	—	—	● UTR-YLBA UTY-ABGX	● UTR-YLBA UTY-ABGX	● UTY-ABGX
	Signal Amplifier		—	—	—	● UTY-VSGX UTR-YRPC	● UTY-VSGX UTR-YRPC	● UTY-VSGX
	External Switch Controller		—	—	● UTR-YESA	● UTR-YESA	● UTR-YESA	● UTY-TEKX
Service & Maintenance	Service Tool		—	—	—	● UTY-ASGX UTR-YSTC	● UTY-ASGX UTR-YSTC	● UTY-ASGX
	Web Monitoring Tool		—	—	—	● UTY-AMGX UTR-YMSA	● UTY-AMGX UTR-YMSA	● UTY-AMGX

# Comparison table of Controllers

Type	Individual control				Centralized control			
	Wired Remote Controller	Simple Remote Controller	Simple <sup>*1</sup> Remote Controller	Wireless Remote Controller	Group Remote Controller	Central Remote Controller	Touch Panel Controller	System Controller (Software)
Model name								
	UTB-YUD UTB-YUB UTY-RNKY	UTB-YPB UTY-RSKY	UTB-YRA UTY-RHKY	UTB-YNA UTB-YVB UTY-LNHY	UTB-YDB UTY-CGGY	UTB-YCA	UTY-DTGY	UTY-APGX
Max. controllable remote controller groups	1	1	1	1	8	400	400	1600
Max. controllable indoor units	16	16	16	16	96	400	400	1600
Max. controllable groups	-	-	-	-	-	64	400	1600
Air conditioning control function	On / Off	●	●	●	●	●	●	●
	Operating mode setting	●	●	-	●	●	●	●
	Fan speed setting	●	●	●	●	●	●	●
	Room temp. setting	●	●	●	●	●	●	●
	Room temp. set point limitation	-	-	-	-	-	●	●
	Test operation	●	●	-	●	-	●	-
	Up/down air direction flap setting	●	-	-	●	-	●	●
	Right/left air direction flap setting	●	-	-	●	-	●	●
	Group setting	-	-	-	-	●	●	●
	RC prohibition	-	-	-	-	●	●	●
	Anti freeze setting	-	-	-	-	●	●	●
	Economy mode setting	●	-	-	●/- <sup>*3</sup>	-	●	●
Display	Failure	●	●	●	-	●	●	●
	Defrosting	●	●	●	-	-	●	●
	Current time	●	-	-	●	●	●	●
	Day of week	●	-	-	-	●	●	●
	R.C. prohibition	●	●	●	-	-	●	●
	Cooling/heating priority	●	●	●	-	●	●	●
	Address display	●	●	●	-	●	●	●
Timer	System schedule timer	-	-	-	-	-	●	●
	On/off per day	-	-	-	-	-	20	72
	On/off per week	-	-	-	-	-	140	504
	Weekly timer	●	-	-	-	●	●	-
	On/off per day	2	-	-	-	2	2	-
	On/off per week	14	-	-	-	14	14	-
	On/off timer	●	-	-	●	-	●	-
	Sleep timer	-	-	-	●	-	-	-
	Program timer	-	-	-	●	-	-	-
	Day off	●	-	-	-	-	●	●
Min. unit of timer setting(Minutes)	30	-	-	5	10	10	10	
Control	Status monitoring system	-	-	-	-	-	●	●
	Electricity charge calculation	-	-	-	-	-	-	●
	Error history	●	●	●	-	●	●	●
	Emergency stop	-	-	-	-	-	● <sup>*2</sup>	-
	Control via internet	-	-	-	-	-	-	●
	E-mail notification for malfunction	-	-	-	-	-	-	●

\*1 "Master control" setting is not available for this model.

\*2 This function is available only through external input. control.

\*3 For UTB-YVB, this function is not available.

## System function

Five types of controllers are available to meet the varied needs of the building and the user. Tighter control over the air conditioned environment can be achieved by combining group remote controller which can operate all the indoor units at the same time, a wired remote controller with a weekly or daily schedule, a wireless remote controller and a simple remote controller.

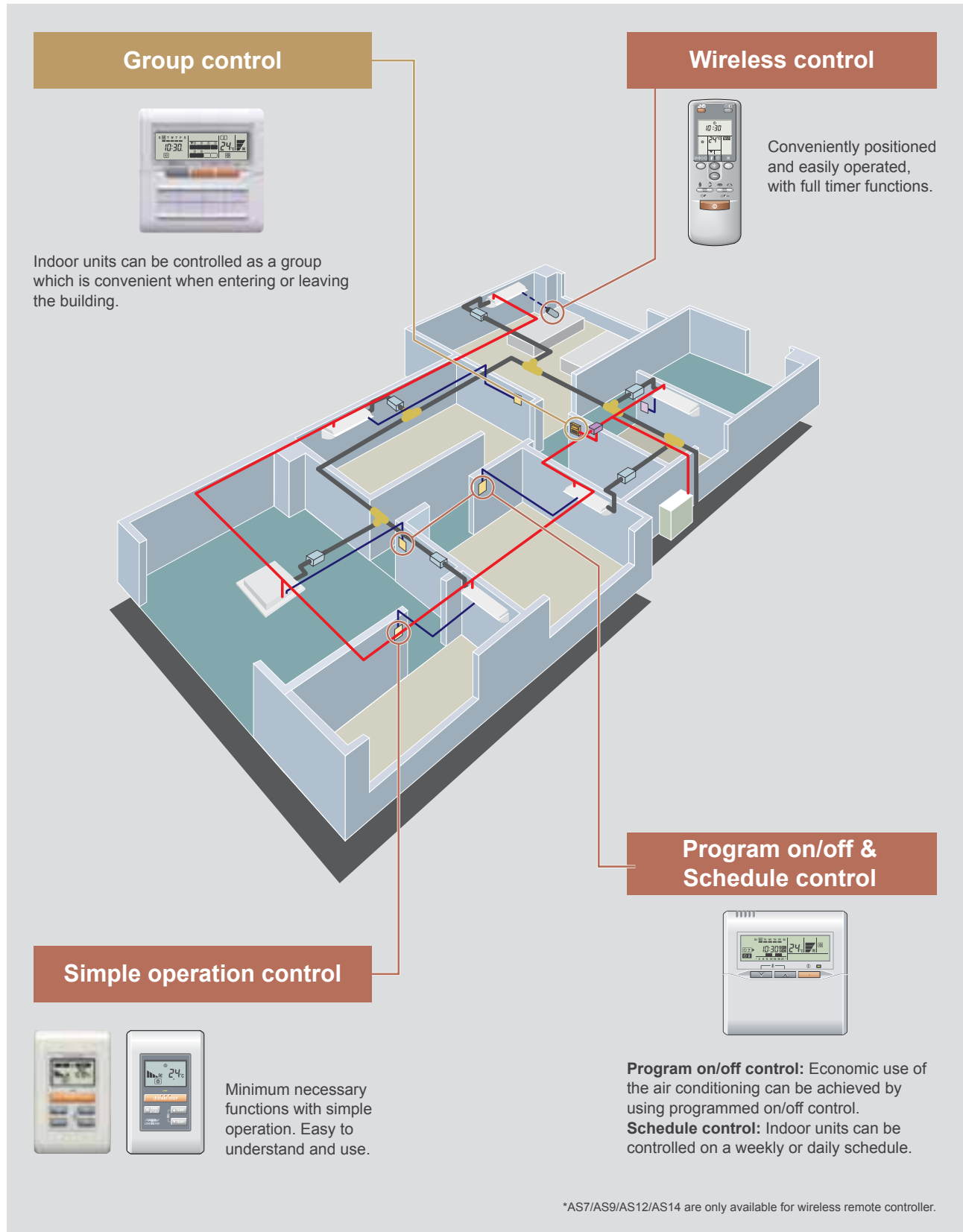

# System diagram

Max. connectable  
**8**  
indoor units

Max. piping length  
**70<sub>m</sub>**

Max. total signal line  
**150<sub>m</sub>**

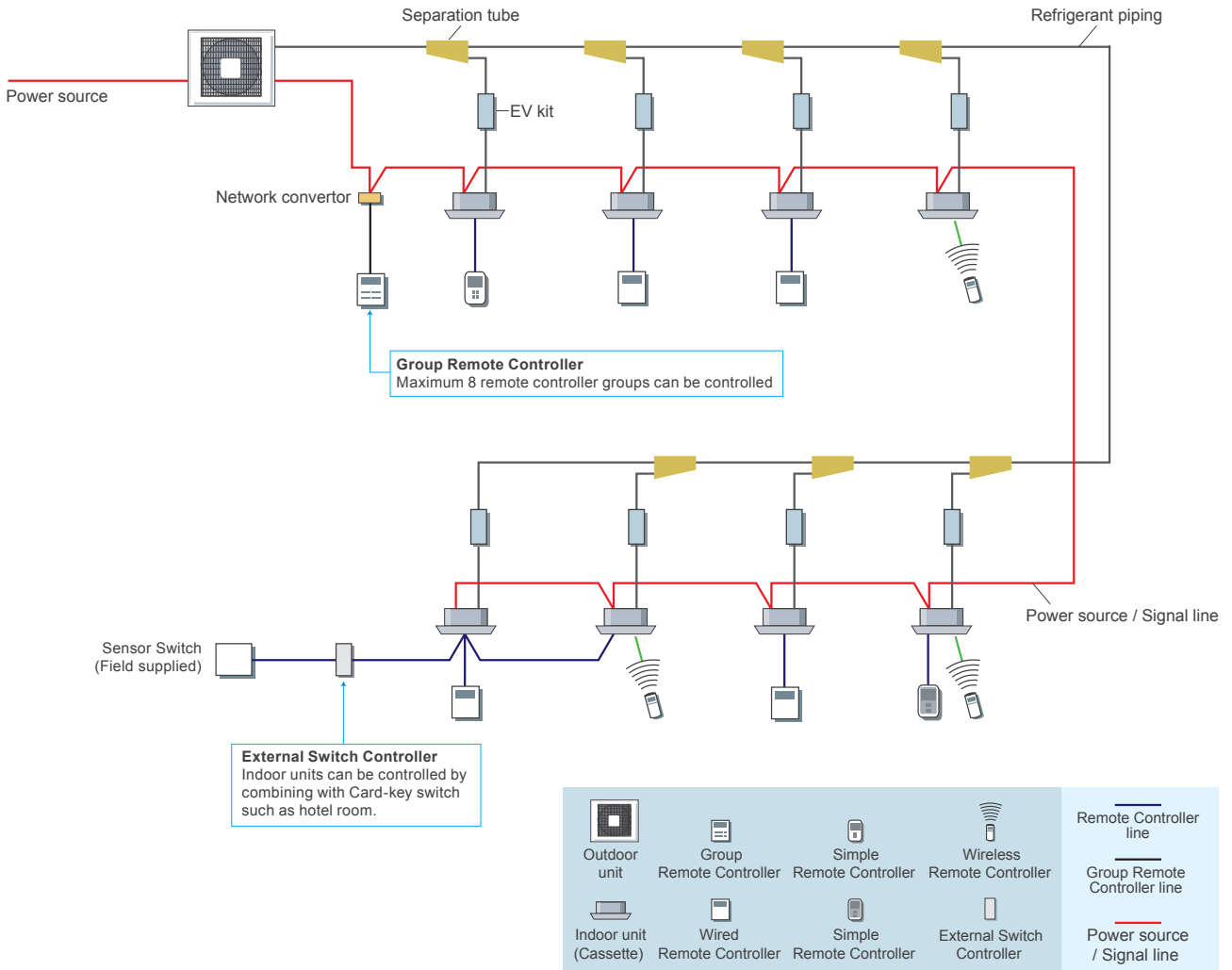

## System diagram

It supports every user's needs by offering a variety of control systems available, such as individual control, central control and building management system control options

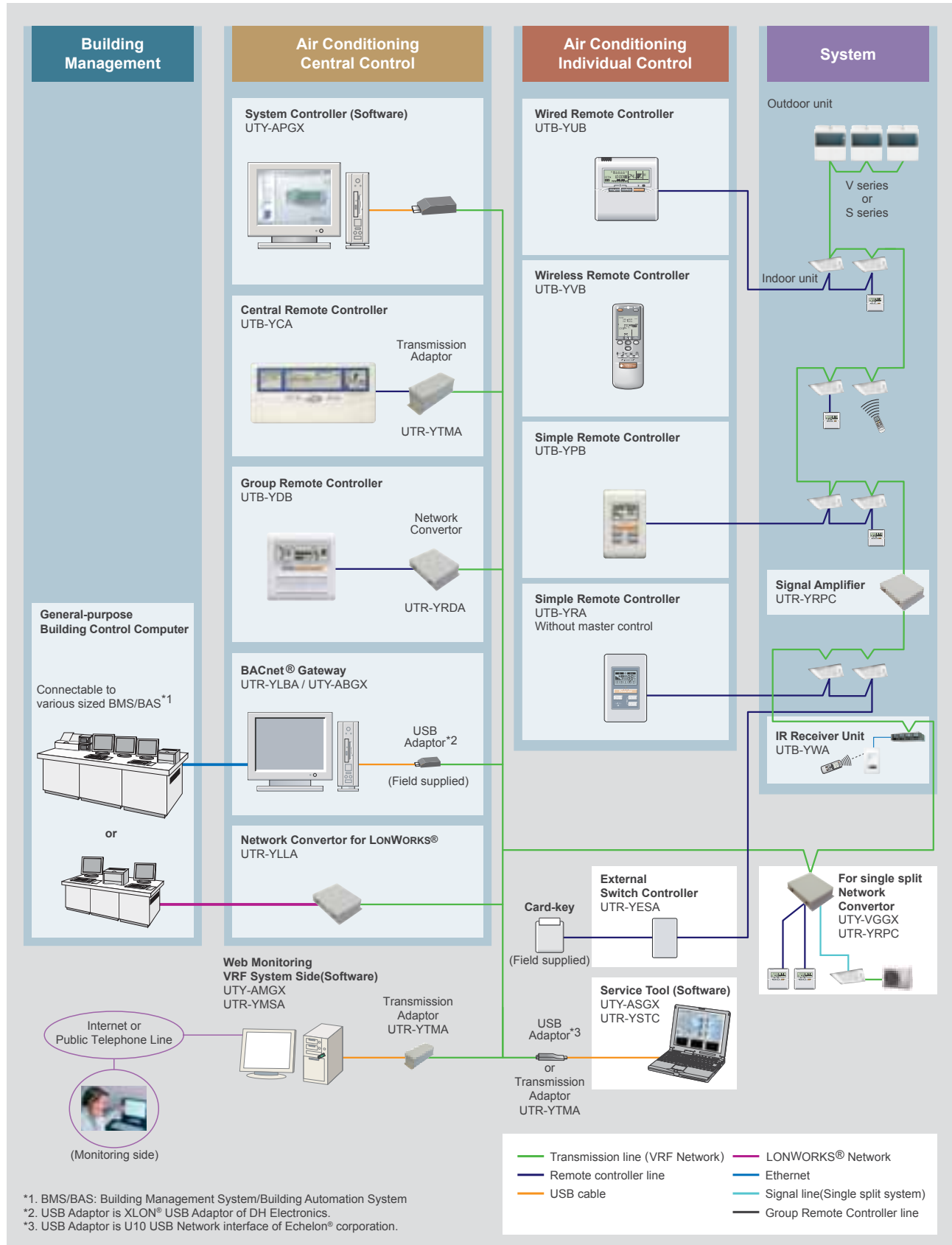



Max. connectable  
**100**  
outdoor units

Max. connectable  
**400**  
indoor units

Max. transmission  
line length  
**1,000m**  
for S series

Max. transmission  
line length  
**2,000m**  
for V series

# Wiring system

- Wiring construction of the control system is made of power source wiring, transmission wiring and remote controller wiring.
- Total wiring length (total length of transmission line) can be extended up to 2000m (by using signal amplifiers).

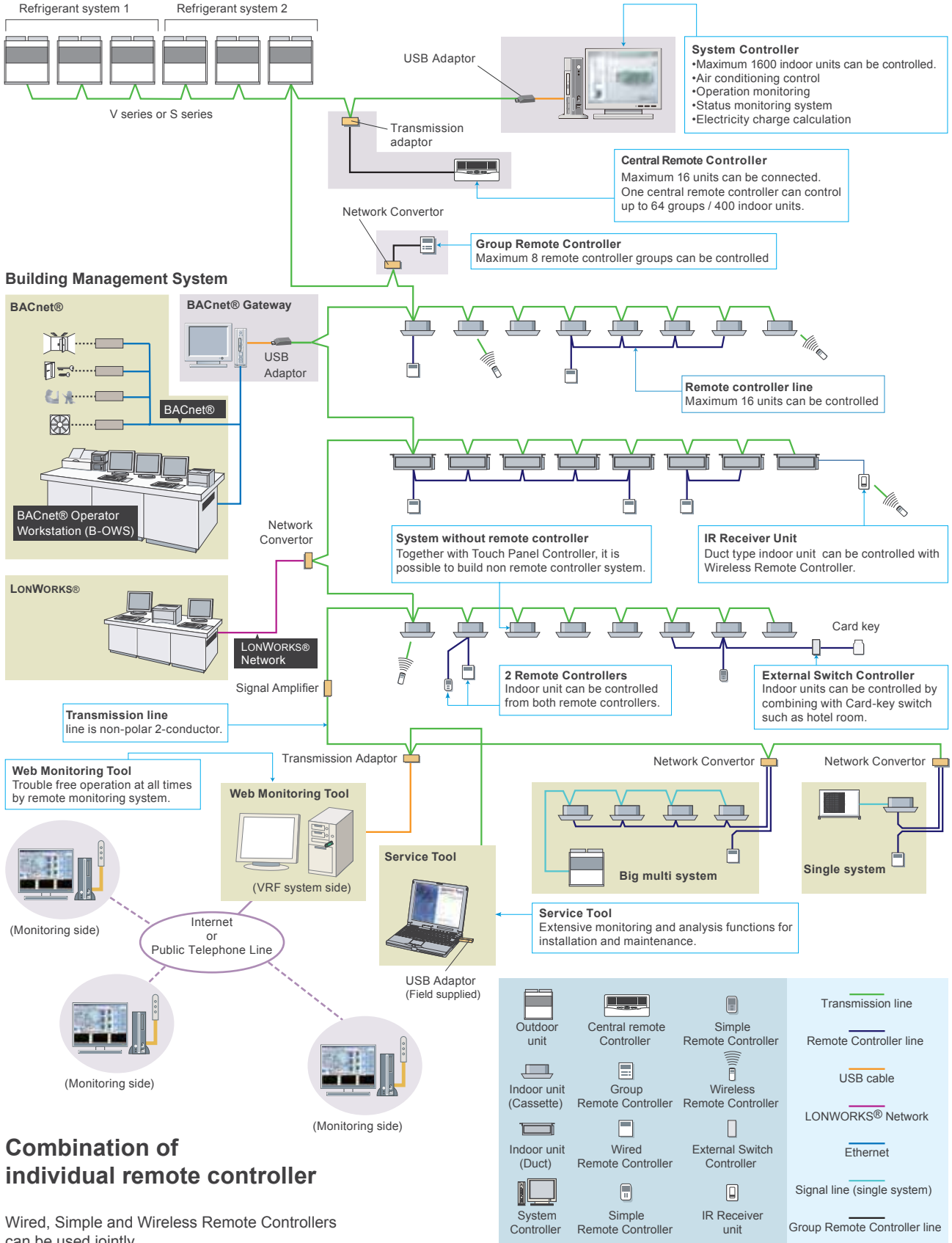

## Combination of individual remote controller

Wired, Simple and Wireless Remote Controllers can be used jointly.

## System diagram

The V-II system supports every users needs by offering a variety of Control systems, including individual control, central control and building management control options.

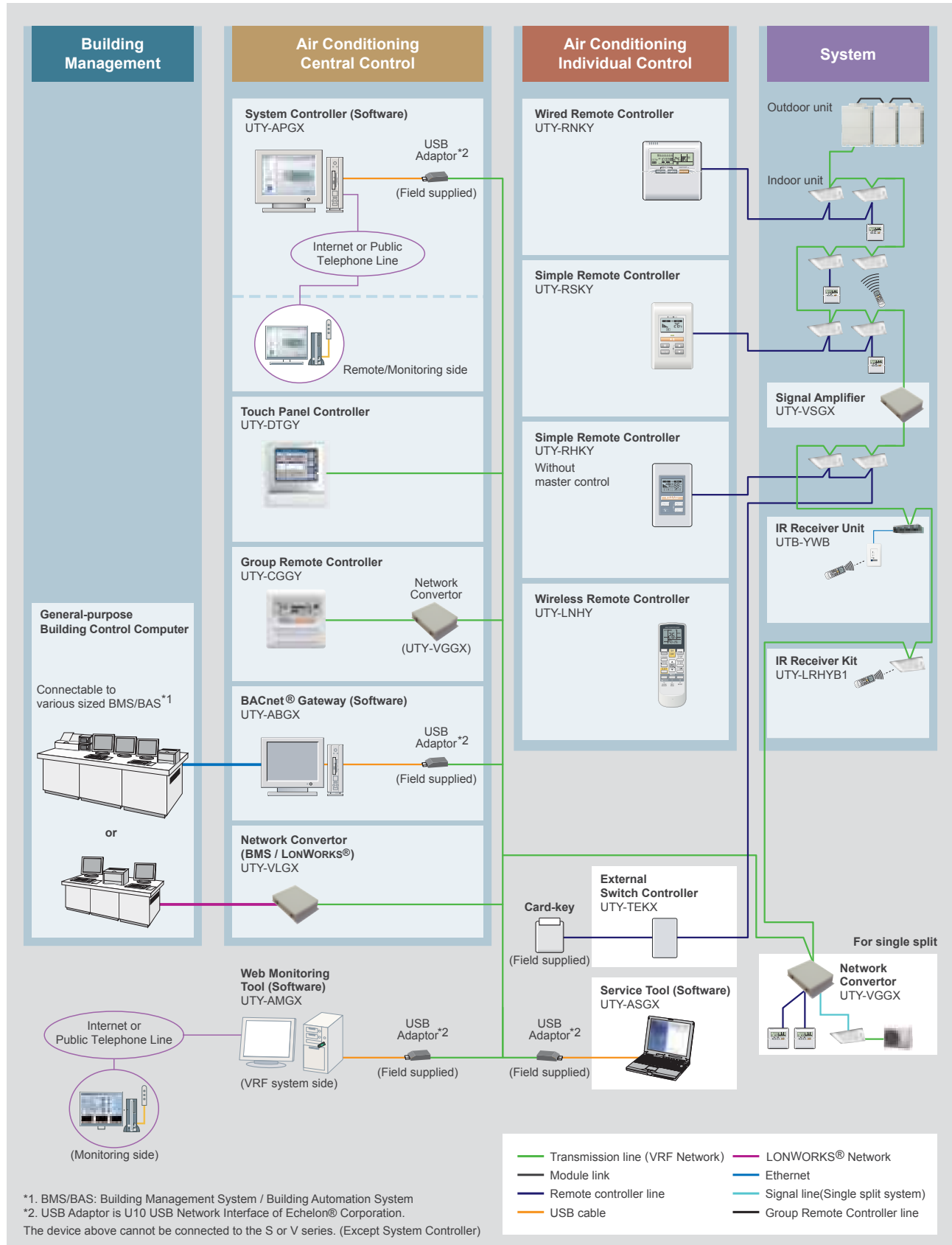

Max. connectable  
**100**  
outdoor units

Max. connectable  
**400**  
indoor units

Max. transmission  
line length  
**3,600m**

# Wiring system

- Wiring construction of the control system is made of power source wiring, transmission wiring and remote controller wiring.
- Total wiring length (total length of transmission line) can be extended up to 3,600m (by using signal amplifiers).

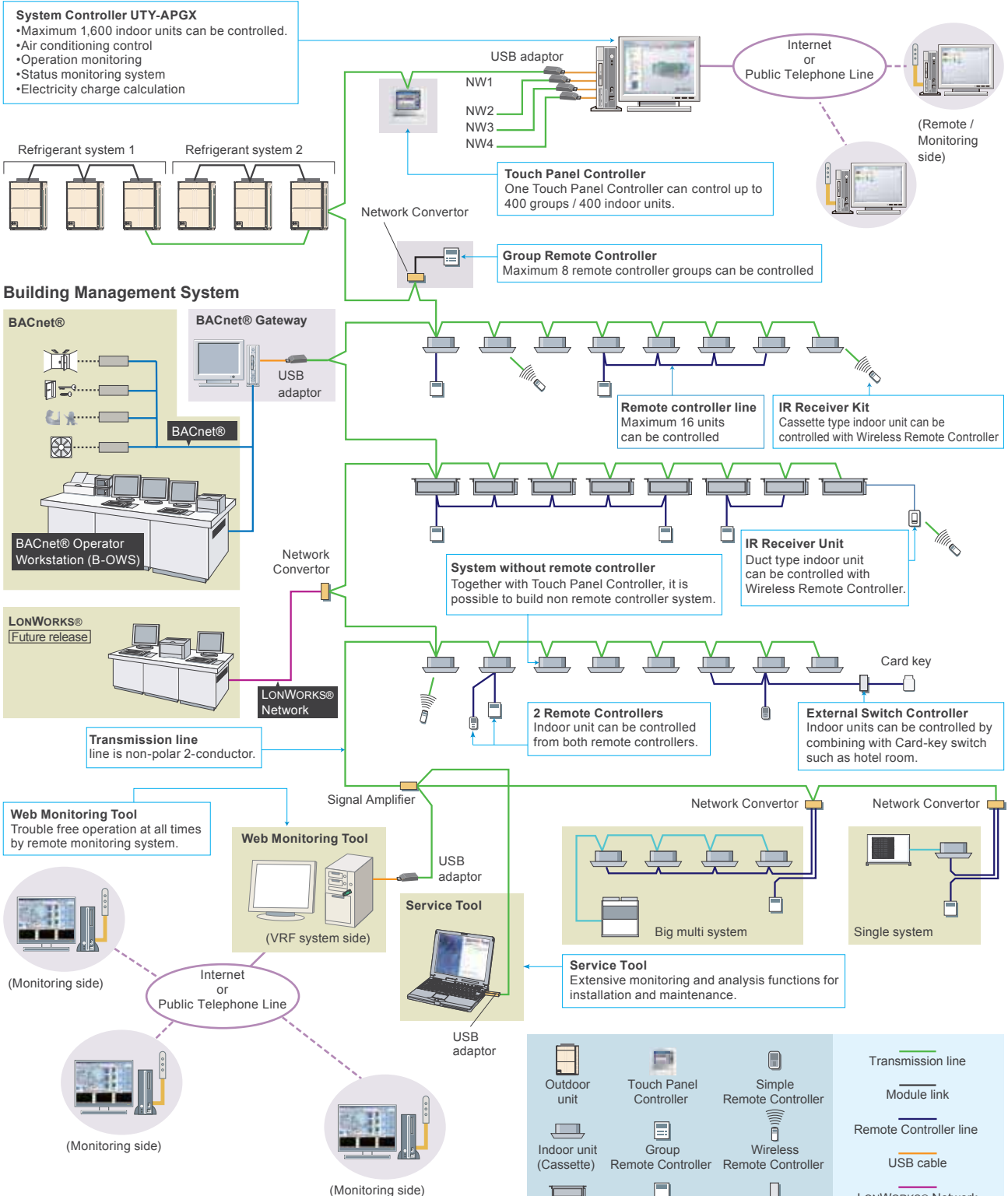

## Combination of individual remote controller

Wired, Simple and Wireless Remote Controllers can be used jointly.

# Controller

## Wired Remote Controller

UTB-YUD/UTB-YUB/UTY-RNKY

The room temperature can be controlled by detecting the temperature accurately from the built-in sensor

- Simple operation with Built-in Weekly / Daily Timer.
- Control up to 16 indoor units.
- Up to 2 wired remote controllers can be connected to a single indoor unit.

Max. controllable  
**16**  
indoor units

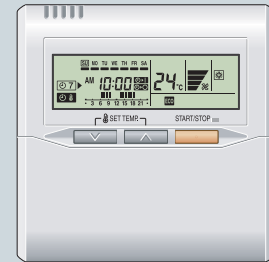

### Accurate and comfortable

Indoor temperature can be detected accurately by the inclusion of a thermo sensor in the body of the wired controller. This new wired remote controller and the optional remote sensor allows flexibility in sensor location, suitable for all requirements.

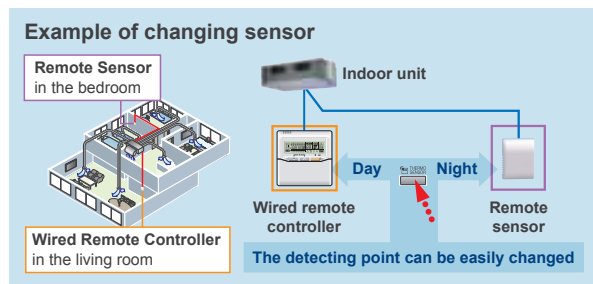

Displayed temperature is set temperature.

### Built-in timers

**Weekly timer:** Possible to set ON/OFF time to operate twice each day of the week.

**Setback timer:** Possible to set temperature for two times spans and for each day of the week.

**At "Weekly timer" + "Set back timer" setup**

### Diagnosis check function

Two methods are available for determining the cause of failure in the event of a malfunction occurs:

### Simple installation

Components are compatible with standard switch boxes. Flat back surface allows to be installed wherever it is needed.

## Simple Remote Controller

UTB-YPB/UTY-RSKY  
UTB-YRA/UTY-RHKY (Without master control)

Compact remote controller provides access to basic functions

- Up to 16 indoor units can be controlled with one remote controller.
- Suitable for hotels or offices as it is easily operated with no complex functions.

Max. controllable  
**16**  
indoor units



UTB-YPB/UTY-RSY UTB-YRA/UTY-RHKY  
Without master control

### User-friendly operation

- A large On / Off button is provided in the centre of the remote controller for easy operation.
- Background light enables easy operation in a darkened room.
- Following an error display, diagnostics can be carried out on the controller.



### Functions

Model	UTB-YPB/UTY-RSKY	UTB-YRA/UTY-RHKY
On / Off	●	●
Fan control	●	●
Master control	●	— *1
Room temp. setting	●	●

\*1: "Master control" setting is not available. It is recommend to use together with other type controller.

## Specifications

Model name	UTB-YUD/UTB-YUB/UTY-RNKY	UTB-YPB/UTY-RSKY	UTB-YRA/UTY-RHKY
Power Source	DC 12V	DC 12V	DC 12V
Dimensions (H x W x D) (mm)	120 x 120 x 17	120 x 75 x 14	120 x 75 x 14
Weight (g)	160	90 (100 : UTY-RSKYT)	90 (100 : UTY-RHKYT)

DC12V is supplied by the indoor unit.

## Wireless Remote Controller

**UTB-YNA/UTB-YVB/UTY-LNHY**

Simple and sophisticated operations with a choice of 4 daily timers

•A single controller controls up to 16 indoor units.

Max. controllable  
**16**  
indoor units

Selectable  
**4**  
daily timers



UTB-YVB



UTB-YNA/UTY-LNHY

### Built-in timers

Select from 4 different timer programs:

On / Off / Program / Sleep

**Program timer:** The program timer operates the ON and OFF timer once within a 24 hour period.

**Sleep timer:** The sleep timer function automatically corrects the set temperature according to the time setting to prevent excessive cooling or heating during sleep hours.

### Easy installation and operation

- Code selector switch prevents indoor unit mix-up. (Up to 4 codes can be set.)
- Wide and precise transmitting range.

### System addressing

During installation work, system addressing can be performed using the Wireless Remote Controller, thus eliminating manual switch setting.

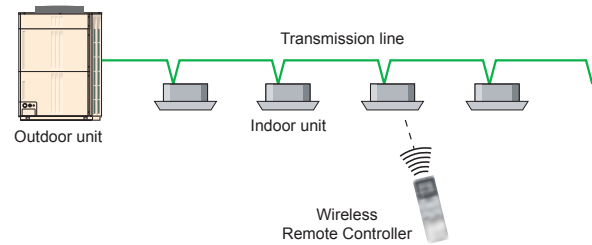

## IR Receiver Unit

**UTY-LRHY1/UTB-YWA/UTB-YWB**

Necessary to control for all duct type by Wireless Remote Controller

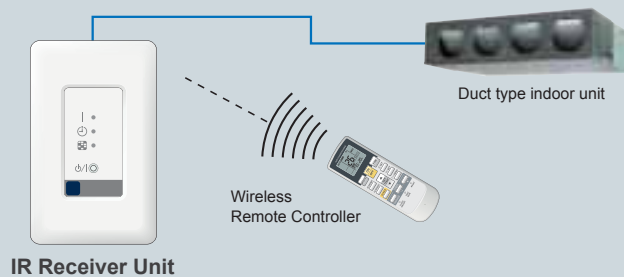

## IR Receiver Kit

**UTY-LRHYA1  
UTY-LRHYB1**

Cassette type indoor unit can be controlled with Wireless Remote Controller

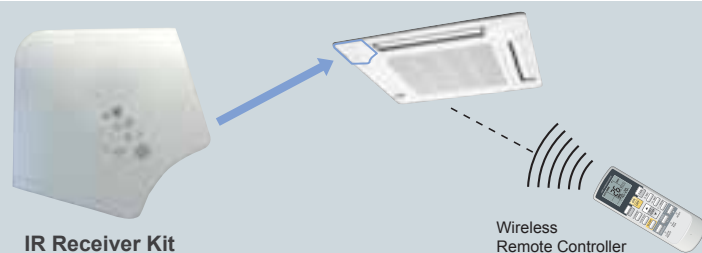

## Specifications

Model name	UTB-YNA/UTB-YVB/UTY-LNHY	UTY-LRHY1/UTB-YWA/UTB-YWB	UTY-LRHYA1/UTY-LRHYB1
Battery	1.5V (R03 / LR03 / AAA) x 2	DC 12V	DC 12V
Dimensions (H x W x D) (mm)	158 x 56 x 20	122 x 60 x 26.5	213.8 x 213.8x 25.7
Weight (g)	70	150	140

# Controller

## Group Remote Controller

UTB-YDB / UTY-CGGY

Group control of indoor units with simple operation

- Up to 8 remote controller groups can be controlled by one Group Remote Controller.
- Up to 64 Group Remote Controllers can be connected in one VRF network system.
- Network Converter is required to connect Group Remote Controllers to a VRF network system.  
(Network Converter allows up to 4 Group Remote Controllers)

Max. controllable  
**64**  
group R.C. in a VRF  
network system

Max. controllable  
**8**  
remote  
controller groups

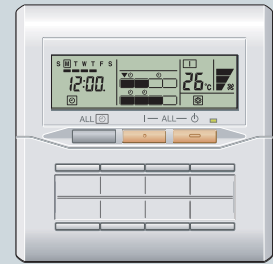

## Control up to 8 remote controller groups

- Single Group Remote Controller controls and monitors up to 8 remote controller groups.

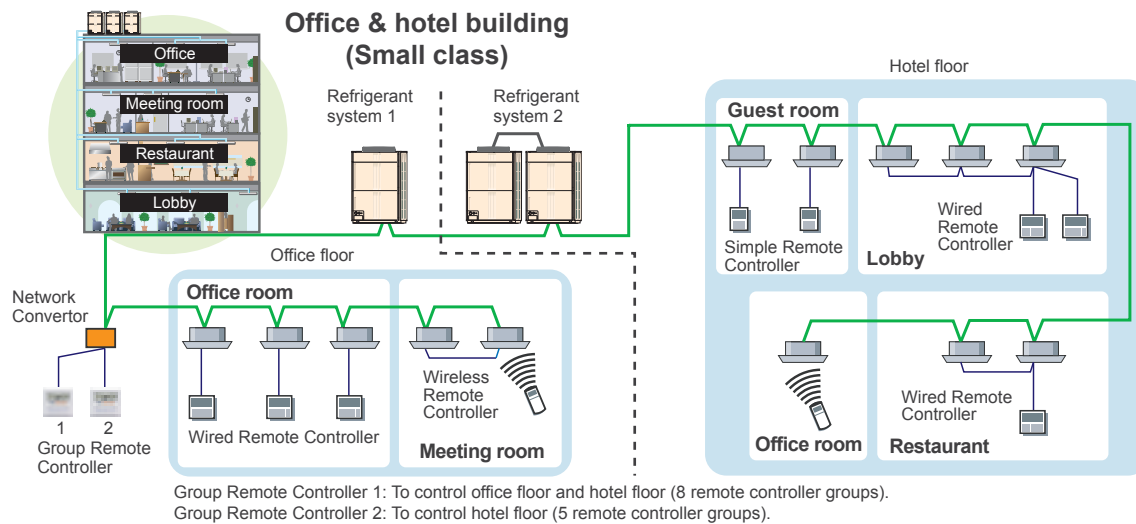

## High performance and compact size

ON / OFF, Operating mode, Room temperature and Fan speed setting can be controlled / monitored centrally or individually.

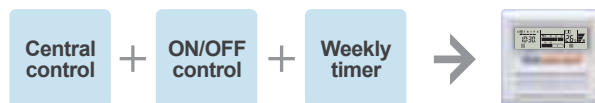

## Built-in weekly timers

The weekly timer is provided as a standard function.

1. The timer can be set up for up to 4 times per day. (On / Off, operating mode, set temperature)
2. Allows separate settings for each day of the week.

## Specifications

Model name	UTB-YDB / UTY-CGGY
Power Source	DC 12V
Dimensions (H x W x D) (mm)	120 x 120 x 17
Weight (g)	200

DC12V is supplied by a network converter.

# Central Remote Controller

## UTB-YCA

### Functionality in a compact housing with built-in weekly timer

- Up to 400 indoor units / 400 remote controller groups / 64 groups can be controlled by one system.
- Up to 16 central remote controllers can be connected into one system allowing operation and monitoring to be achieved from the central control room, at each floor, by each tenant, or in the plant room.

Max. controllable  
**400**  
indoor units

Max. controllable  
**400**  
remote controller groups

Max. controllable  
**64**  
groups



## Control up to 400 indoor units

- The central remote controller performs system control after you select All Groups, User Defined Groups, or Individual Remote Controller Groups.
- Accurate control of functions such as Start / Stop, Operating Mode, Temperature, and Air Velocity ensures occupancy comfort.

### Controllable method

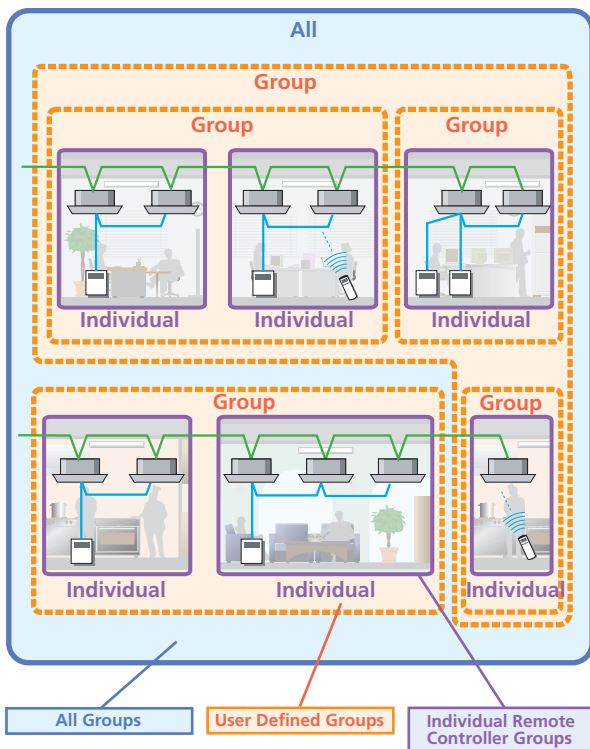

## Central control

Any of 6 functions of the individual remote controller can be locked from the Central Remote Controller: all functions, timer mode, operating mode, temperature setting, filter reset, on/off. All functions can be controlled via the Central Remote Controller only.

## Easy Installation

- The controller can be installed on any flat surface.
- The control panel and transmission adaptor can be installed separately.
- For flexibility in installation, the main unit can be built into the wall or exposed.

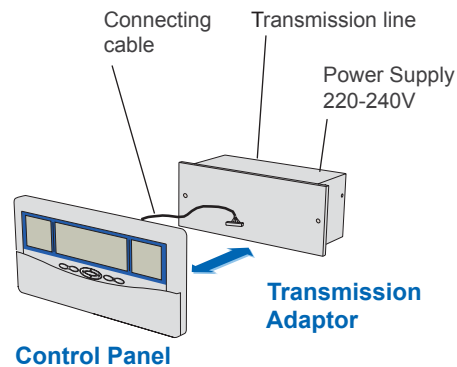

## Functions

- Built-in weekly timer
- Memory functions
- Error display

## Specifications

Model name	UTB-YCA	
	Control Panel	Transmission Adaptor
Power Source	DC 12V	220-240V 50-60Hz Single phase
Power Consumption (W)	4.8	
Fuse Capacity (A)	3	
Dimensions (H x W x D)(mm)	143 x 296 x 22	107 x 288 x 100
Weight (g)	550	1,300

### PACKING LIST

Packing List	Control Panel / Transmission Adaptor / Connecting Cable
--------------	---



# Controller

## Touch Panel Controller

### UTY-DTGY

- Large-sized 7.5-inch TFT color
- LCD Easy finger touch operation
- Stylish shape and design to suit all application
- No additional component is required for installation
- Up to 400 indoor units can be controlled
- Selectable 2 display types (Icon / List) in monitoring mode

7.5 inch  
screen

Stylish  
design

Max. controllable  
**400**  
indoor units



## Easy operation

- Wide range of simple-to-understand icons
- Operation can be selected using your finger or the dedicated touch pen by pressing the appropriate on-screen icon
- Up-to-date status display
- Background color identifies current control operation blue for monitoring, green for operational control

## Functions



Individual control



Flexible grouping



Schedule control

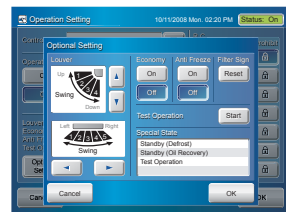

Indoor units operation monitoring

## Versatility

- Emergency stop function: Air conditioner can be turned off through the external input control
- The stored data can be transferred via USB port
- CSV format data edited by PC can be imported to Touch Panel Controller.

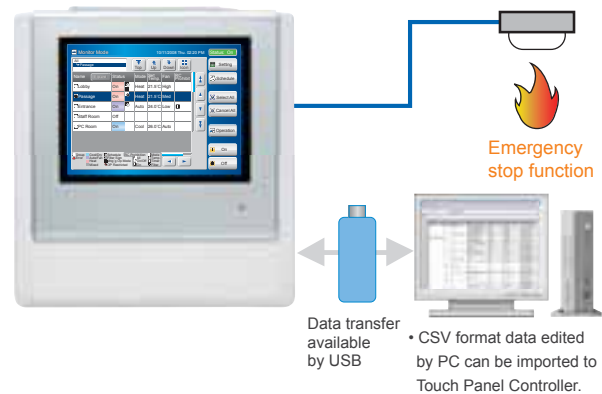

## Easy installation

- Touch Panel Controller is easily mounted to the wall.
- Flat back surface allows to be installed wherever it is needed.
- No additional component is required for installation.



## Specifications

Model name	UTY-DTGY
Power Source	100-240V 50/60Hz
Dimensions (H x W x D) (mm)	260 x 246 x 54
Weight (g)	2,150
Interface	USB 2.0

# System Controller

## UTY-APGX

This system realizes the advanced general monitoring and control of VRF system from small scale buildings to large scale buildings.

- Supports VRF S series, V series and V-II series.

Max. controllable  
**4**  
VRF system

Max. controllable  
**400**  
outdoor units

Max. controllable  
**1,600**  
indoor units

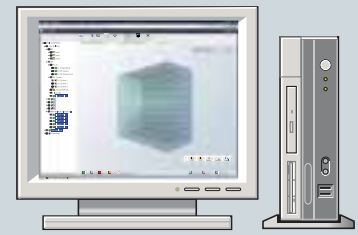

## Remote centralized control

System controller may be used on site or remotely over various networks for remote central control. System controller requires 2 softwares working together. Server program runs in the background and communicate with VRF System. Client program provides user interface and communicate with the Server. Server and client program may run in a single PC or in different PCs separated by network. By using client software, one PC can perform central control and web control of 10 VRF system sites with max. 20 buildings per site.

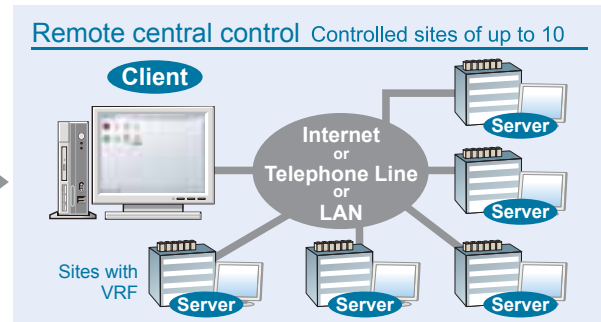
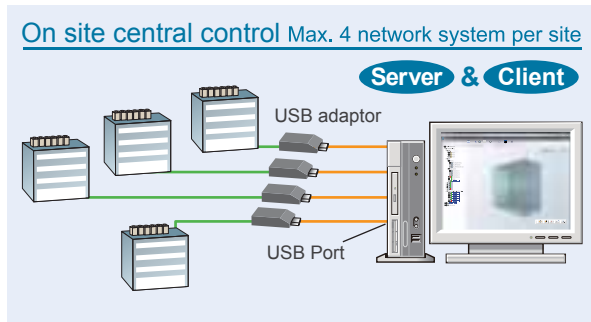

## User friendly view and operation

Monitoring located site

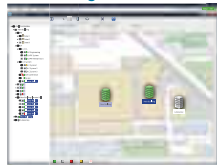

Monitor mode (Site)

Main operation monitoring screen

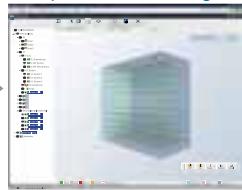

Monitor mode (Building)

Operation monitoring of each site

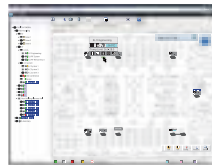

Monitor mode (Floor)

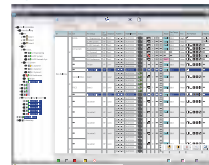

Monitor mode (List)

Management functions



Schedule setting

## Functions

- Electricity charge calculation
- Error display
- Diverse control of indoor units
- Schedule control
- Operating & control record
- Energy saving function

## Specifications

Personal Computer	AT compatible machine that runs Microsoft® Windows®
Operating System	Microsoft® Windows® Vista Home Premium, Business, Ultimate Edition Microsoft® Windows® XP Professional with Service Pack2 or later
CPU	Intel® Pentium® / Celeron 2GHz (Server), 1GHz (Client) or higher
HDD	40GB or more of free space (5GB for Client PC)
Memory	1GB or more
Interface	USB port is required for each of the followings for Server PC; -Wibu Key (Software protection key) - Echelon® U10 USB Network Interface (Required for each VRF Network) Ethernet port is required for remote connection using internet.
Accelerator	Requires the internal graphics accelerator be compatible with Microsoft® DirectX® 9.0 or later.
<b>PACKING LIST</b>	
CD-ROM	Includes the software for System Controller. Both server and client software is included.

# Adaptor & Converter

## Transmission Adaptor

### UTR-YTMA / UTR-YTMB

- For air conditioning of the medium and large size buildings, the control software can control and monitor air conditioners together with the ones in the other buildings.
- This device enables control by other equipment via an Interlink cable or connection cable.
- Up to 400 Indoor units / 100 Outdoor units can be connected to one Transmission Adaptor.

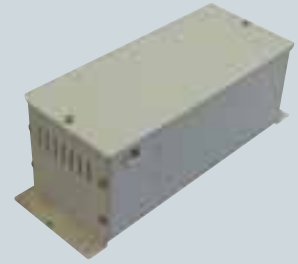

### Installation example

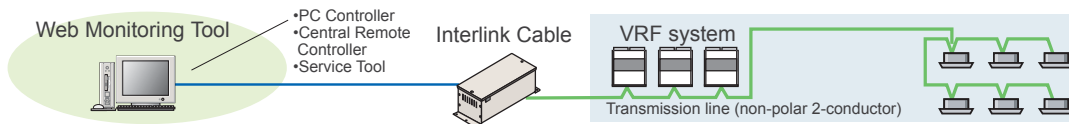

## Network Converter

Max. controllable  
**16**  
Network  
Converter units

### UTR-YRDA / UTY-VGGX / UTR-YGCA

- This network converter is to be used for connecting single split system or group remote controller with the VRF system.
- Please select the function by switching the dip switch during the installation.

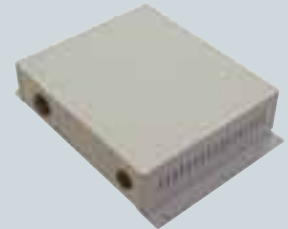

### Installation example

- Split type systems can be controlled from a central remote controller or PC controller through connection to the VRF's network converter.
- Standard remote controller and central remote controller provide On / Off control, master control, temperature and fan control, etc.
- A single network converter can be used to connect and control up to 16 single units.

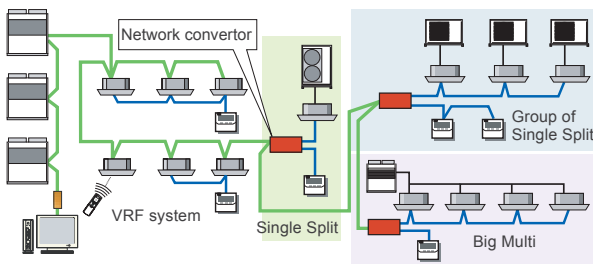

Please consult your distributor for connectable split type air conditioner. Up to 100 network converters may be connected in a single VRF system. A single network converter is considered as a single refrigerant system, irrespective of the number of connected single models.

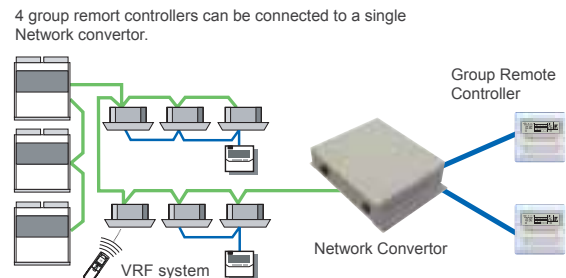

\* 2 refrigerant circuits can be covered by a single network converter. Up to a total of 16 network converters and central remote controller adapters can be connected in a single VRF system.

## Specifications

Model name	UTR-YTMA / UTR-YTMB
Power Source	50-60Hz 220-240V
Power Consumption (W)	2.9
Fuse Capacity	3A
Dimensions (H X W X D) (mm)	100 x 288 x 110
Weight (g)	1,300

Model name	UTR-YRDA / UTY-VGGX / UTR-YGCA
Power Source	50-60Hz 220-240V
Power Consumption (W)	8.5
Dimensions (H X W X D) (mm)	67 x 288 x 211
Weight (g)	1,500

# Network Convertor for LONWORKS®

Max. controllable  
**128**  
indoor units

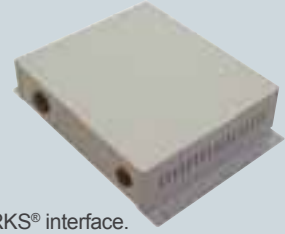

## UTR-YLLA / UTY-VLGX (Future Release)

- For connection between VRF system and a LONWORKS® open network for management of small to medium-sized BMS and VRF systems.
- The UTY-VLGX permits central monitoring and control of a VRF system from a BMS through a LONWORKS® interface.
- Up to 128 Indoor units can be connected to one Network Convertor for LONWORKS®

### Installation example

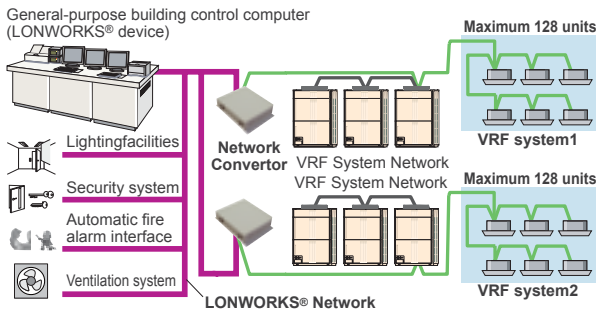

### Transmission specifications (BMS side)

Transmission speed	78kbps
Transceiver	FTT-10A
Transmission way form	Free topology
Terminated resistor	None (It attaches at the terminal of a network.)

# BACnet® Gateway

Software

Max. controllable  
**4**  
VRF system

Max. controllable  
**400**  
outdoor units

Max. controllable  
**1,600**  
indoor units

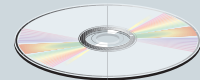

CD-ROM (Software)

Software Protection Key

## UTR-YLBA / UTY-ABGX (Future Release)

- The VRF system can be incorporated into a Building Management System.
- Enables central control of up to 1,600 indoor units through BACnet®, a global standard for open networks.
- Conforms to ANSI / ASHRAE Standards® 135-2001 BACnet® Application Specific Controller (B-ASC) BACnet® / IP over Ethernet.
- Connects up to 4 VRF systems (1,600 indoor units / 400 outdoor units) per gateway.

### Installation example

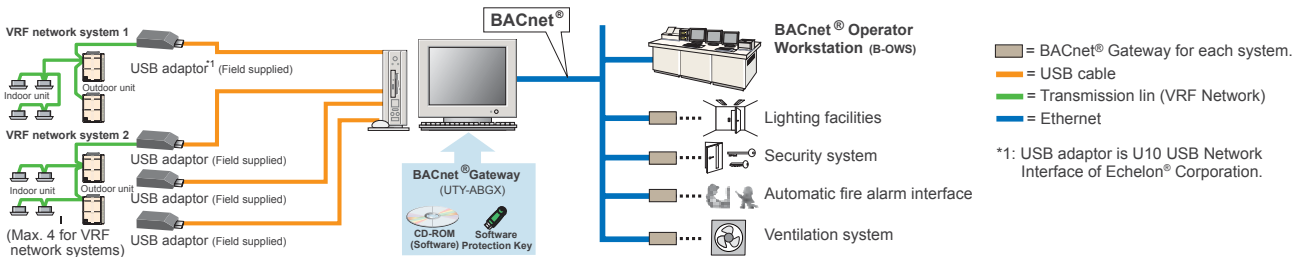

## Specifications

Model name	UTR-YLLA / UTY-VLGX
Power Source	220-240V 50/60Hz
Power Consumption (W)	4.5
Dimensions (H X W X D) (mm)	67 x 288 x 211
Weight (g)	1,500

Personal Computer	AT compatible machine that runs Microsoft® Windows®
Operating System	Microsoft® Windows® Vista Home Premium, Business, Ultimate Edition Microsoft® Windows® XP Professional with Service Pack2 or later
CPU	Intel® Pentium® / Celeron 2GHz or higher
Memory	1GB (Vista) , 512MB (XP) or more
Interface	USB port is required for each of the followings; -Wibu Key (Software protection key) - Echelon® U10 USB Network Interface (Required for each VRF Network) Ethernet port is required
Other Software Required	Adobe® Acrobat® reader 4.0 or later

### PACKING LIST

Packing List	CD-ROM / Wibu Key
--------------	-------------------

# Adaptor & Convertor, Service & Maintenance

## Signal Amplifier

UTR-YRPC / UTY-VSGX

- Transmission Line length can be extended up to 3,600m with multiple Signal Amplifiers.
- Up to 8 signal amplifiers can be installed in a VRF network system.
- A signal amplifier is required,
  - (1) When the total wiring length of the transmission line exceeds 500m.
  - (2) When the total number of units on the transmission line exceeds 64.

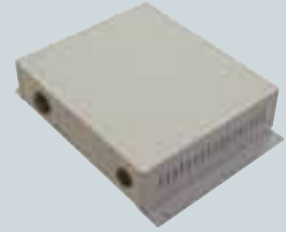

### Installation example

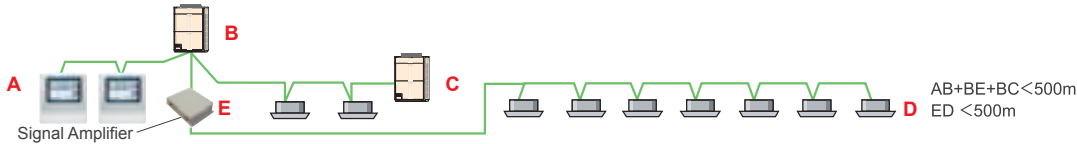

## External Switch Controller

UTR-YESA / UTY-TEKX

**Air conditioner switching can be controlled by connecting other sensor switches**

- In combination with a field supply Card-Key Switch or other sensor, the External Switch Controller allows control of the ON / OFF, Room temperature, Fan speed and Master control functions. This makes this product suitable for installations such as hotel rooms.
- Card-key or other sensor switches are available as a field supplied parts.

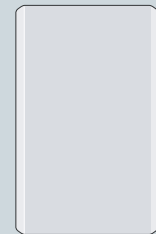

### Installation example

- Auto mode operation, which switches the cooling and the heating automatically, is enabled by using the sensor switch and External Switch Controller.
- Note: All indoor units will operate in the same mode.

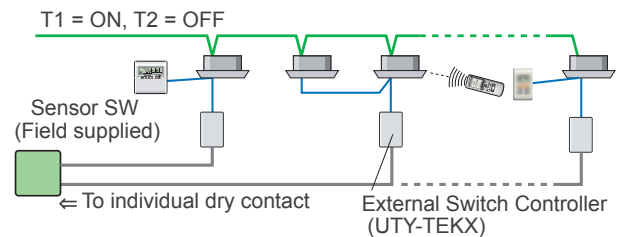
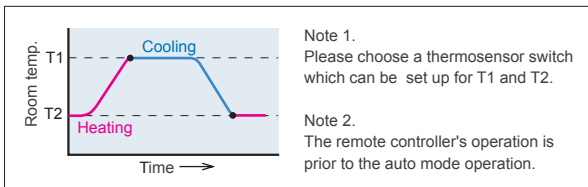

### Electrical wiring

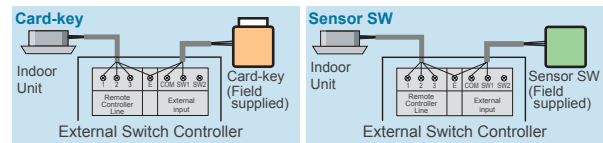

## Specifications

Model name	UTR-YRPC / UTY-VSGX
Power Source	220-240V 50/60Hz
Power Consumption (W)	4.5
Dimensions (H X W X D) (mm)	67 x 288 x 211
Weight (g)	1,500

Model name	UTR-YESA / UTY-TEKX
Power Source	DC 12V
Dimensions (H X W X D) (mm)	120 x 75 x 30
Weight (g)	90

DC12V is supplied by the indoor unit.

## Service Tool Software

### UTR-YSTC / UTY-ASGX

Extensive monitoring and analysis functions for installation and maintenance

- Operation status can be checked and analyzed to detect even the smallest abnormalities
- Storage of data on system operation status on a PC allows access even from off site.
- Up to 400 indoor units (a single VRF system) can be controlled and monitored for large scale buildings or hotels
- This software can be connected to any point of transmission line with USB adaptor (field supplied).

Max. Monitor and control  
**400**  
indoor units

Max. Monitor and control  
**100**  
outdoor units



## Wiring connection

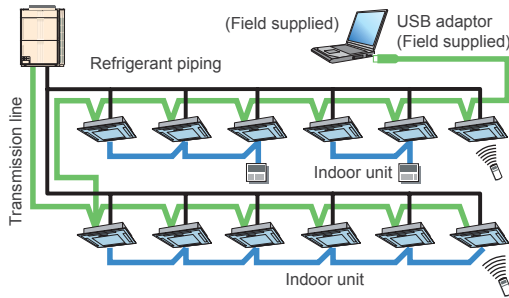

## Functions

• Equipment Detail (Diagram)



- Equipment Detail (List)
- Error History
- Remote File Download
- System List
- Commissioning Tool

## Web Monitoring Tool Software

### UTR-YMSA / UTY-AMGX

Product features

- Troubleshooting is performed by monitoring each air conditioning unit remotely during periodical system checks.
- Error notification can be automatically transmitted to several locations using the internet\*1.
- Requires either a dedicated internet connection\* or public telephone line.
- Determination of an error occurrence can be made through error warnings and equipment status information obtained from a remote location.
- The monitoring data in a remote side can be optionally downloaded. And, this data can be displayed in offline mode of the service tool.
- Monitoring side computer is not required to install special software, requires only general web browser.

VRF system can be supported  
**4**

**1,600**  
indoor units can be supported

## Web Monitoring System

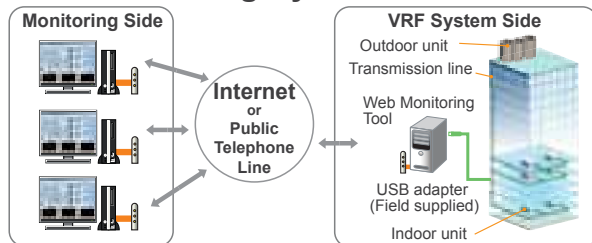

## Support 4 VRF system

• USB adaptor (max. 4 adaptors per PC) permit, monitoring of up to 1,600 indoor units.  
Suitable for large-scale buildings or hotels.

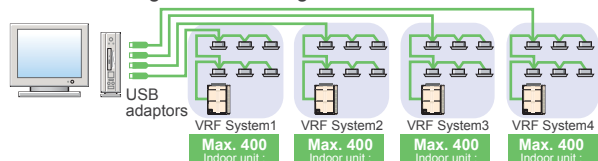

\*1:USB of internet mail system required.

## Specifications

Model name	UTR-YSTC / UTY-ASGX	UTR-YMSA / UTY-AMGX
Personal Computer	AT compatible machine that runs Microsoft® Windows®	
Operating System	Microsoft® Windows® 2000 Professional (English version / Service pack4 or later), XP Professional (English version / Service pack2 or later) Microsoft® Windows® Vista Home Premium, Business, Ultimate Edition. (English version)	
CPU	Intel® Pentium® / Celeron®, AMD AthlonTM / DuronTM 1GHz or higher	
HDD	4.1 GB or more of free space	
Memory	1GB (Vista) , 512MB (XP/2000) or more	1GB or more
Interface	USB port is required for each of the following ; -Wibu Key(Software protection key) -Echelon® U10 USB Network Interface(Required for each VRF Network)	USB port is required for each of the following ; -Wibu Key(Software protection key) -Echelon® U10 USB Network Interface(Required for each VRF Network) Ethernet port is required for remote connection using internet.
Software	Internet Explorer 6.0 or later / Adobe® Acrobat® Reader 4.0 or later	
Hardware	USB Adaptor is U10 USB Network interface of Echelon® corporation.	

### PACKING LIST











Packing List	CD-ROM / Wibu Key
--------------	-------------------

Personal computer must be field supplied. U10 USB Network Interface must be field supplied. Contact Echelon® Corporation or its local sales representative for detail.  
Product Name : U10 USB Network Interface - TP/FT-10 Channel Model Number: 75010R







# Optional Parts

## Controllers



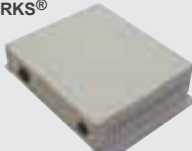

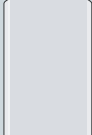





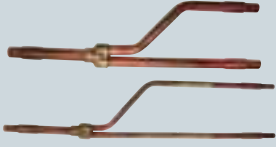

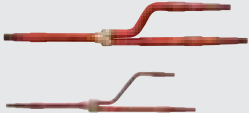
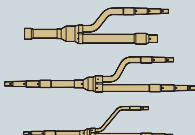



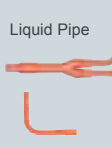
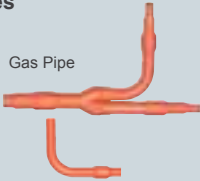

<p><b>System Controller</b></p>  <p>UTY-APGX</p>	<p><b>Touch Panel Controller</b></p>  <p>UTY-DTGY</p>	<p><b>Central Remote Controller</b></p>  <p>UTB-YCA</p>
<p><b>Group Remote Controller</b></p>  <p>UTB-YDB/UTY-CGGY</p>	<p><b>Wired Remote Controller</b></p>  <p>UTB-YUD</p>	<p><b>Wired Remote Controller</b></p>  <p>UTB-YUB/UTY-RNKY</p>
<p><b>Simple Remote Controller</b></p>  <p>UTB-YPB/UTY-RSKY With master control</p>	<p><b>Simple Remote Controller</b></p>  <p>UTB-YRA/UTY-RHKY Without master control</p>	<p><b>Wireless Remote Controller</b></p>  <p>UTB-YVB</p>
<p><b>Wireless Remote Controller</b></p>  <p>UTB-YNA/UTY-LNHY</p>		

## Adaptors/Convertors

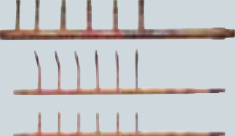
<p><b>Transmission Adaptor</b></p>  <p>UTR-YTMA/UTR-YTMB</p>	<p><b>Network Converter</b></p>  <p>UTR-YRDA/UTR-YGCA/UTY-VGGX</p>	<p><b>Network Converter for LONWORKS®</b></p>  <p>UTR-YLLA/UTY-VLGX</p>
<p><b>BACnet® Gateway</b></p>  <p>CD-ROM (Software) Software Protection Key</p> <p>UTR-YLBA/UTY-ABGX</p>	<p><b>Signal Amplifier</b></p>  <p>UTR-YRPC/UTY-VSGX</p>	<p><b>External Switch Controller</b></p>  <p>UTR-YESA/UTY-TEKX</p>



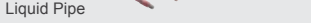







# Connection Units

<p><b>Separation Tube</b> For 3-phase simultaneous multi</p>  <p>UTP-SX236A</p>	<p><b>Separation Tube</b> For 3-phase simultaneous multi</p>  <p>UTP-SX254A</p>	<p><b>Separation Tube</b> For 3-phase simultaneous multi</p>  <p>UTP-SX354A</p>
<p><b>Separation Tube</b> For J series Separation tubes are available for installation as necessary.</p>  <p>UTR-BP54U/UTR-BP054X</p>	<p><b>Separation Tube</b> For S series Separation tubes are available for installation as necessary.</p>  <p>UTR-BP54MA/UTR-BP90MA</p>	<p><b>Separation Tube</b> For V and V-II Series</p> <p>Gas Pipe</p>  <p>Liquid Pipe</p>  <p>UTR-BP090X</p>
<p><b>Separation Tube</b> For V and V-II Series</p> <p>Gas Pipe</p>  <p>Liquid Pipe</p>  <p>UTR-BP180X</p>	<p><b>Separation Tube</b> For V and V-II Series</p> <p>Gas Pipe</p>  <p>Liquid Pipe</p>  <p>UTR-BP567X</p>	<p><b>Outdoor Unit Branch Kit</b> For V and V-II Series</p> <p>Liquid Pipe</p>  <p>Gas Pipe</p>  <p>UTR-CP567X</p>
<p><b>RB (Refrigerant Branch) Unit</b> For S series</p> <p>Single type</p>  <p>UTF-Y54A1A</p>	<p><b>RB (Refrigerant Branch) Unit</b> For S series</p> <p>Multi type</p>  <p>UTF-Y90A4A</p>	<p><b>Header</b> For J series Headers are available for installation as necessary.</p>  <p>UTR-HD546U</p>
<p><b>Header</b> For S series Headers are available for installation as necessary. *Reducer is attached to each header kit.</p>  <p>UTR-HD906R</p>	<p><b>Header</b> For S series Headers are available for installation as necessary. *Reducer is attached to each header kit.</p>  <p>UTR-HD908R</p>	<p><b>Header</b> For V and V-II Series</p> <p>Gas Pipe</p>  <p>Liquid Pipe</p>  <p>UTR-H0906L/UTR-H1806L</p>
<p><b>Header</b> For V and V-II Series</p> <p>Gas Pipe</p>  <p>Liquid Pipe</p>  <p>UTR-HD908L/UTR-H1808L</p>	<p><b>EV Kit</b> For J series EV kit is available for installation as necessary.</p>  <p>UTR-EV2AXL/UTR-EV3XL</p>	

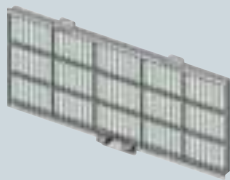

# Optional Parts

## Others

**For Duct type**

<p><b>Flange(Round)</b></p>  <p>UTD-RF204</p>	<p><b>Flange(Square)</b></p>  <p>UTD-SF045T</p>	<p><b>Long-Life Filter</b></p>  <p>UTD-LF25NA</p>
<p><b>Long-Life Filter</b></p>  <p>UTD-LF60KA</p>	<p><b>Drain Pump Unit</b></p>  <p>UTZ-PX1BBA/UTZ-PX1NBA</p>	<p><b>IR Receiver Unit</b></p>  <p>UTY-LRHY1/UTB-YWA/UTB-YWB</p>
<p><b>Remote Sensor Unit</b></p> <p>New amenity space can be offered by installing the Remote sensor in the remote controller.</p>  <p>UTD-RS100</p>	<p><b>External Control Set</b></p> <p>Use to connect with various peripheral devices and air conditioner PC board.</p>  <p>UTD-ECS5A</p>	

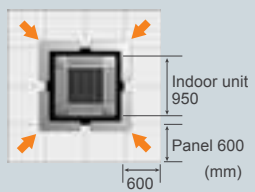
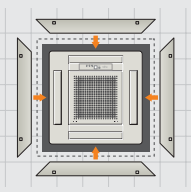
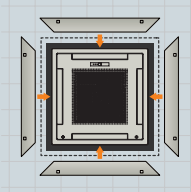
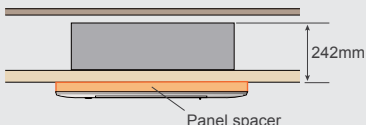
**For Cassette type**

<p><b>Wide Panel</b></p>  <p>Indoor unit 950 Panel 600 (mm) 600</p> <p>UTG-AGYA-W</p>	<p><b>Additional Grille</b></p>  <p>UTG-AGDA-W</p>	<p><b>Additional Grille</b></p>  <p>UTG-AGEA-W</p>
<p><b>Panel Spacer</b></p>  <p>242mm Panel spacer</p> <p>UTG-BGYA-W</p>	<p><b>Air Outlet Shutter Plate</b></p> <p>Shuts the air outlet when only using as 2 or 3 blow out.</p>  <p>UTR-YDZC</p>	<p><b>Air Outlet Shutter Plate</b></p> <p>Shuts the air outlet when only using as 2 or 3 blow out.</p>  <p>UTR-YDZB</p>

**Insulation Kit**  
For High Humidity

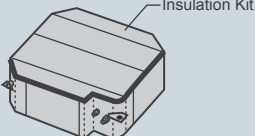

Insulation Kit

UTZ-KXGA/UTZ-KXGC

**IR Receiver Kit**



UTY-LRHYA1

**IR Receiver Kit**



UTY-LRHYB1

**Grille Kit**



UTG-UDYD-W

**Grille Kit**



UTG-UFYC-W

**Grille Kit**



UTG-UGYA-W

**For Ceiling type**

**Drain Pump Unit**



UTR-DPB24T

**For Floor type**

**Half Concealed Kit**

This kit is used to half conceal floor type indoor unit into the wall.

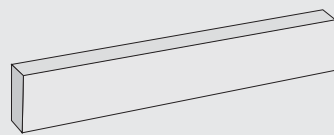

UTR-STA

**For Wall Mounted type and Floor type**

**External Indication Kit**

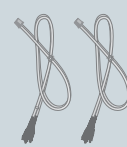

UTY-XWZX

**For Wall Mounted type**

**Air Clean Filter**

Air clean filter assembly for initial setting.

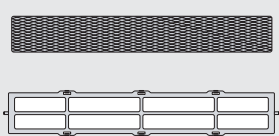

UTR-FA08

**Air Clean Filter**



UTR-FB03

**EV Kit**

For without EV Kit model (V and V-II series)



UTR-EV09XA/UTR-EV14XA/  
UTR-EV09XB/UTR-EV14XB

**Sub Interface Board**

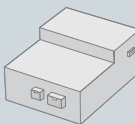

UTY-XCBXE

# Energy Recovery Ventilator



Suppresses indoor temperature changes while providing fresh air

High efficiency and low noise are achieved using a highly efficient element. Comfortable air-conditioned environment is provided by effectively determining whether to use heat-exchange ventilation or normal ventilation while meeting diverse needs.



## Energy *saving* ventilation

*Thanks to efficient recovery of thermal energy lost during Ventilation, you can save an air-conditioning fee.*

## Facility *saving*

*Thanks to a drastic reduction of load incurred by outside air, you can make air-conditioners more compact in parallel with the recovery of thermal energy.*

## Humidity *adjusting* effect

*In a cooling mode, a highly humid open-air is brought near to a dehumidified room atmosphere and then supplied. In a heating mode, a room humidity is transferred to the dry outside air and then supplied.*

## Sound *shield* effect

*The ducts of the unit and the heat exchange element are characteristic of sound shield effect, so that the office and store environment can be preserved.*



MORE COMFORTABLE AIR CONDITIONING

**Energy Recovery Ventilator**

FUJITSU GENERAL LIMITED

# Energy Recovery Ventilator

Energy recovery ventilator unit offers maximum comfort and greater energy savings.



UTZ-BX025A



UTZ-BX035A



UTZ-BX050A



UTZ-BX080A



UTZ-BD100A

Adopts a highly efficient counter-flow heat exchange element

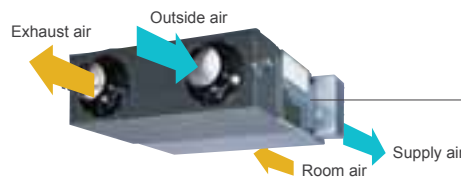

## Heat exchange ventilation and normal ventilation

### Heat exchange ventilation

When a room is cooled or heated, the exhausted cooling / heating energy is recovered by heat-exchange ventilation.

### Normal ventilation

This is used in the spring and autumn, when rooms are not cooled or heated, that is, when there is little difference between the indoor and outdoor air conditions. In addition, at night during the hot season, when the outside air temperature drops the outside air is drawn inside without heat exchange, alleviating the load on the air conditioning equipment.

## High Efficiency

### Energy efficiency and ecology

**20%**  
Energy saving

Energy consumption is dramatically reduced by using a counterflow heat-exchange element. Air conditioning load is reduced by approximately 20%, resulting in significant energy savings. Recovers up to 77% of the heat in the outgoing air.

### Features of heat exchange element

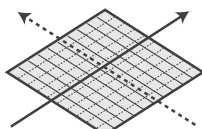

Other element  
(Cross-flow element)

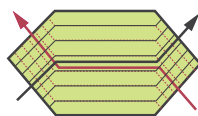

Fujitsu element  
(Counter-flow element)

With the cross-flow element, air moves in a straight line across the element. With the counter-flow element, air flows through the element for a longer time (longer distance), so the heat-exchange effect remains unchanged.

## More Comfort

### Quiet operation

Significantly reducing low pressure loss and noise allows low-noise operation of 32 dB (High) or less for models with a capacity of 500 m<sup>3</sup>/h or less, and 37.5 dB (High) for models with a capacity of 1,000 m<sup>3</sup>/h.

### Long heat-exchanger service life

Cleaning reduced due to the special material heat exchanger. The nylon/polyester fibre filter offers high dust retention capacity.



# Easy Installation and Maintenance

## Slim shape and easier installation

Counter-flow heat exchange element used for reduced noise and slimmer, more compact body shape.

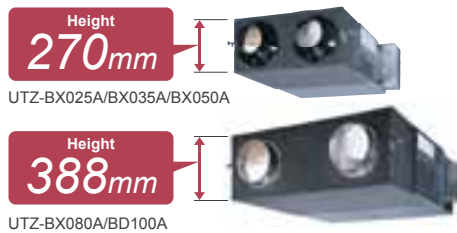

## Reverse mountable direct air supply / exhaust system

**Adoption of straight air supply / exhaust system:** Duct design is simplified because the air supply / exhaust ducts are straight.

**Since each unit can be mounted in reverse position, only one inspection hole is needed for two units:** Two units can share one inspection hole so duct work is easier and more flexible.

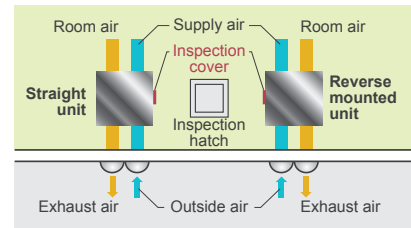

## Dimensions

Models: UTZ-BX025A / UTZ-BX035A / UTZ-BX050A / UTZ-BX080A / UTZ-BD100A

(Unit : mm)

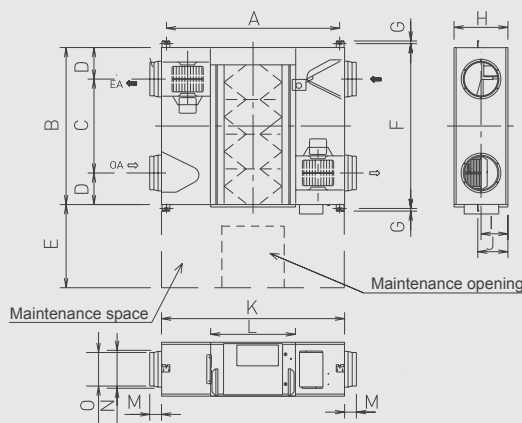

	UTZ-BX025A	UTZ-BX035A	UTZ-BX050A	UTZ-BX080A	UTZ-BD100A
A	810	810	890	1,250	1,250
B	599	804	904	884	1,134
C	315	480	500	428	678
D	142	162	202	228	228
E	600	600	600	600	600
F	655	860	960	940	1,190
G	19	19	19	19	19
H	270	270	270	388	388
I	135	145	145	194	194
J	159	159	159	218	218
K	882	882	962	1,322	1,322
L	414	414	414	612	612
M	95	95	107	85	85
N	219	219	246	258	258
O	144	144	194	242	242

## Specifications

Rated flow rate		250 m³/h	350 m³/h	500 m³/h	800 m³/h	1000 m³/h	
Model No.		UTZ-BX025A	UTZ-BX035A	UTZ-BX050A	UTZ-BX080A	UTZ-BD100A	
Power source		220-240V , 50Hz					
HEAT EXCHANGE VENTILATION	Input power	(Extra high)/High/Low W	119 / 99 / 79	154 / 124 / 117	214 / 169 / 151	347 / 309 / 302	445 / 360 / 332
	Air flow rate	(Extra high)/High/Low m³/h	250 / 250 / 170	350 / 350 / 280	500 / 500 / 370	800 / 800 / 650	1,000 / 1,000 / 810
	External static pressure	(Extra high)/High/Low Pa	90 / 80 / 37	95 / 65 / 42	105 / 70 / 38	140 / 110 / 70	90 / 55 / 35
	Temperature Exchange Efficiency	(Extra high)/High/Low %	75 / 75 / 77	75 / 75 / 77	75 / 75 / 77	75 / 75 / 76	75 / 75 / 76
	Energy Exchange Efficiency Cooling	(Extra high)/High/Low %	63 / 63 / 66	66 / 66 / 69	62 / 62 / 67	65 / 65 / 68	65 / 65 / 68
	Energy Exchange Efficiency Heat pump	(Extra high)/High/Low %	70 / 70 / 73	69 / 69 / 71	67 / 67 / 71	71 / 71 / 74	71 / 71 / 73
NORMAL VENTILATION	Sound pressure level	(Extra high)/High/Low dB*	28 / 26 / 21	32 / 29 / 25	34 / 31 / 25	38 / 36.5 / 32	37.5 / 36 / 31
	Input power	(Extra high)/High/Low W	119 / 98 / 79	151 / 119 / 113	210 / 161 / 145	337 / 300 / 297	438 / 358 / 329
	Air flow rate	(Extra high)/High/Low m³/h	250 / 250 / 170	350 / 350 / 280	500 / 500 / 370	800 / 800 / 650	1,000 / 1,000 / 810
	External static pressure	(Extra high)/High/Low Pa	90 / 80 / 37	95 / 65 / 42	105 / 70 / 38	140 / 110 / 70	90 / 55 / 35
	Sound pressure level	(Extra high)/High/Low dB*	27 / 26.5 / 21.5	31 / 30 / 26	34 / 32 / 26.5	38.5 / 37 / 33	38 / 36.5 / 31.5
	Dimensions	W×D×H mm	882×599×270	882×804×270	962×904×270	1,322×884×388	1,322×1,134×388
Weight	kg	29	37	43	71	83	
Outlet duct diameter	mm	150	150	200	250	250	
Operation range	°C	-10 to 40	-10 to 40	-10 to 40	-10 to 40	-10 to 40	
Maximum humidity	%	85	85	85	85	85	

\* The noise level must be measured 1.5 m below the centre of the unit.



# Window



Quickly transforms your room into an oasis

## The Airflow Direction can be Freely Adjusted

Unrestricted direction of airflow. The louver allows airflow coverage as wide as 140°. Mounting the louver in the center provides coverage of an area as wide as 140°. Cold or warm air is distributed throughout the room.

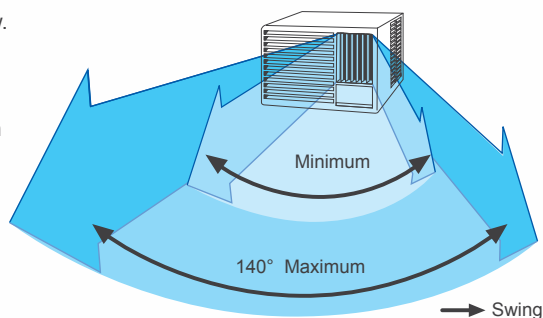

## Easy filter cleaning

The filter can be cleaned without removing the front panel.

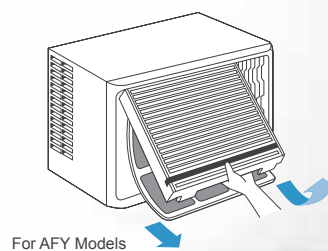

## Specifications

Model No.			AKY9UB	AMY12UA	AFY16UA
Power Source		V/∅/Hz	230/1/50	230/1/50	230/1/50
Capacity	Cooling	kW	2.80	3.45	4.55
	Heating		2.90	3.60	4.30
Power Consumption	Cooling/Heating	kW	1.05/0.93	1.40/1.30	1.81/1.62
EER - Energy Class	Cooling	W/W	2.67-D	2.46-E	2.51-E
COP - Energy Class	Heating		3.12-D	2.77-E	2.65-E
Running Current	Cooling/Heating	A	4.7/4.2	6.2/5.8	8.0/7.2
Moisture Removal		l/h	0.9	1.1	2.1
Noise (Indoor)	Cooling	H/L	dB(A)	50.5/41.5	52/48
Air Flow (High)	Indoor / Outdoor			350	530
Net Dimension H x W x D		mm	349x457x581	375x560x650	400x660x633
		kg(lbs)	33(73)	45(99)	61(134)
Operation Range	Cooling	°CDB	21~43	21~43	21~43
	Heating		0~21	0~21	0~21
Refrigerant			R410A	R410A	R410A
Feature	Super Power		—	●	●
	Super Quiet		●	●	●
	Super Wave		●	●	●
	Instant Air Exchange		●	●	●



AKY9UB



AMY12UA



AFY16UA



# 3 models

COMPACT, HIGH POWER, AND LOW NOISE

Window type Air Conditioners

FUJITSU GENERAL LIMITED

# Air to Water

Efficient and comfortable heating solution



**WATERSTAGE™** is a safe, comfortable, and efficient water heating system by adopting heat pump technology that utilizes the heat in the air.

**This system provides support for space heating and water heating.**

This WATERSTAGE™ uses very little electric energy to efficiently absorb heat from the atmosphere by adopting an inverter heat pump. A small environmental load heat source system can be economically realized by using this heat energy to produce hot water for radiator, floor heating or domestic hot water.

Flexible and comfortable heating solution for new building and refurbishment house

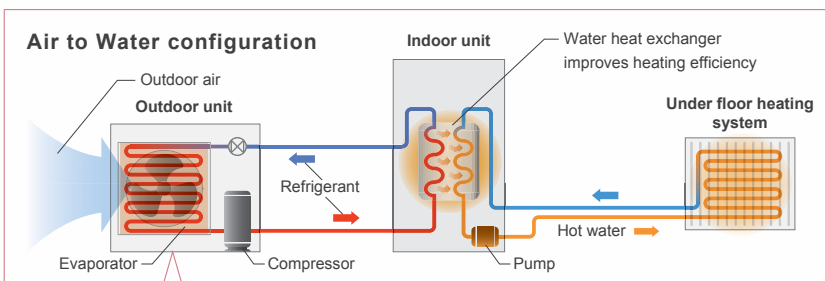
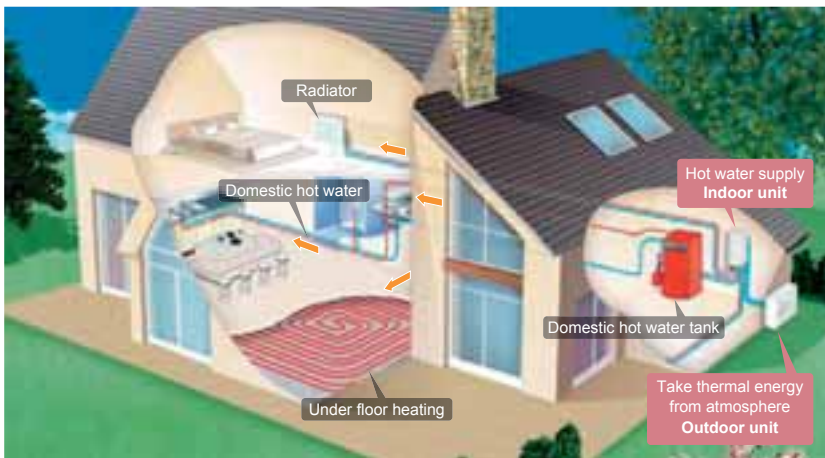

### Heat Pump is most efficiency system

Absorbing the free energy from atmosphere. Heat pump system requires only 1kW of electricity to generate 3 to 5 kW thermal energy.

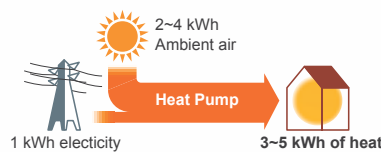



**WATERSTAGE™**

FUTURE SOLUTION OF DOMESTIC HEATING

**Air to Water**

FUJITSU GENERAL LIMITED



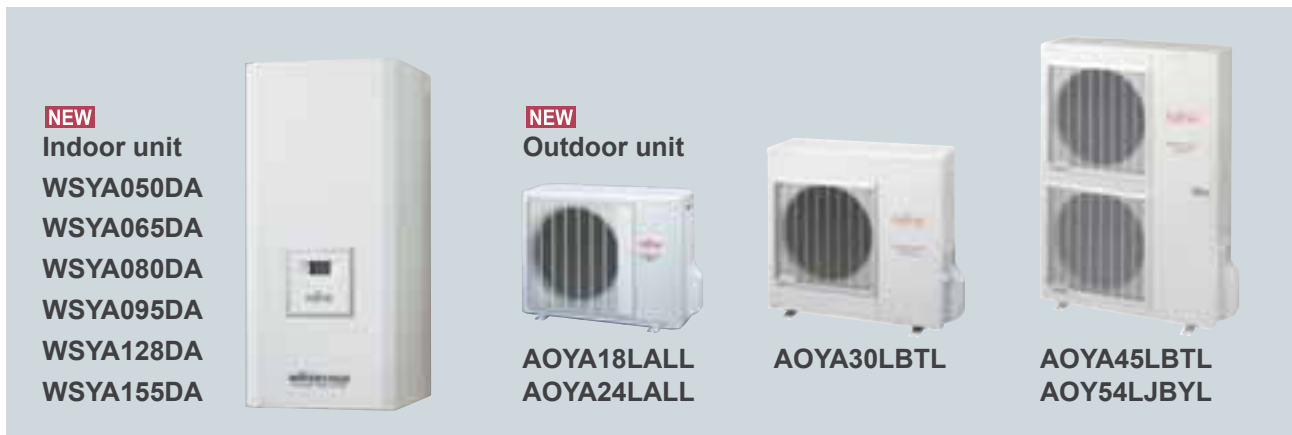

## High Efficiency

### High COP

Air to water heat pumps work with much more efficiency and save more energy than a traditional heating system.

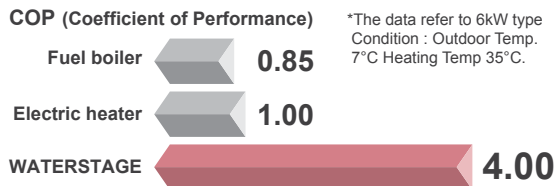

### Highly efficient water heat exchanger

Double-pipe water heat exchanger with built-in tank to reduce loss

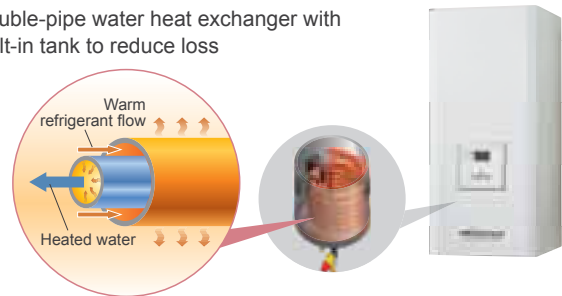

### Technology DC inverter with R410A

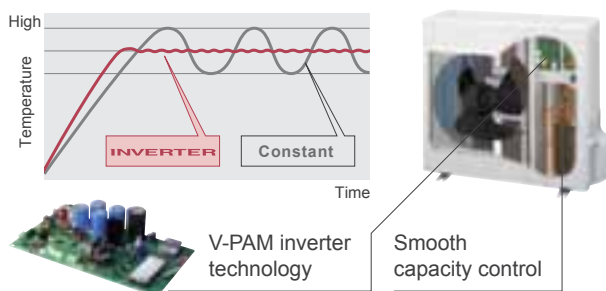

### Low ambient temperature performance

Achieves excellent heating performance even at an outdoor air temperature of -15°C.



## High Reliability

### High Clean and Durability

- Corrosion protected
- No fouling through heat exchanger construction
- Hot water is permanently available
- Heating until -15°C

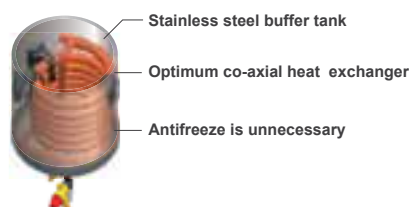

# Intelligent Control System

## Intelligent regulation

Intelligent operation system of WATERSTAGE™ system is provided to regulate the efficient and comfortable temperature according to your needs.

- Automatic temperature regulation in accordance with heating curve (depends on terminal and outdoor temperature).
- 2 Zone individual control (2 under floor heating zones or under floor heating + radiator zone, etc.)\*

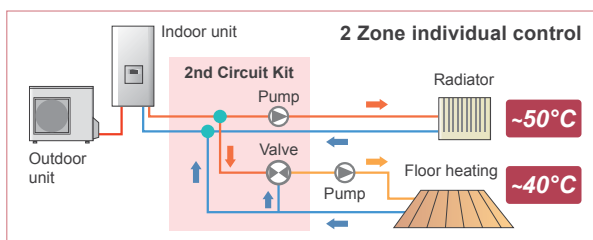

\*Optional parts are required.

- Water temperature regulation can be combined with Room thermostat.\*



Room Thermostat  
UTW-C55XA

- Additional electric heater control for backup
- Domestic hot water management with hot water tank\*
- Boiler docking is possible\*
- Cooling operation is possible\*
- Swimming pool heating\*
- Anti legionella function

## Smart operation

- Simple design system
- Hourly, Daily, Weekly programming operation
- Holiday operation mode
- Operation status display
- Error display / Error history



# Design Versatility

## Installation example

The water heating system can be freely constructed for a wide range of applications from floor heating to hot water showers.

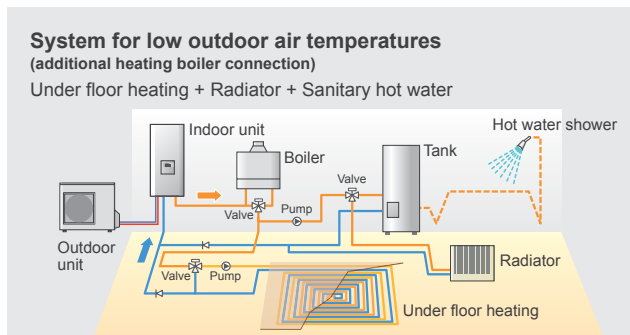
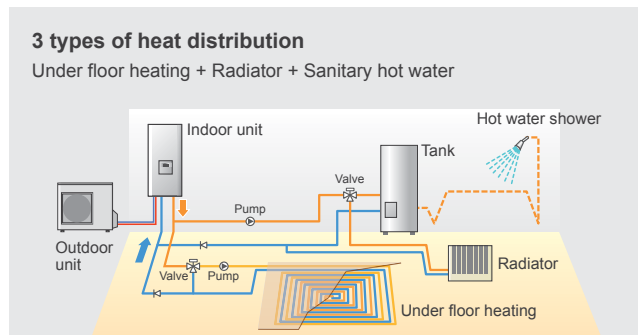
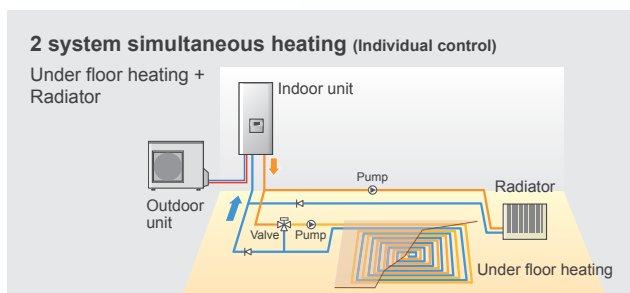
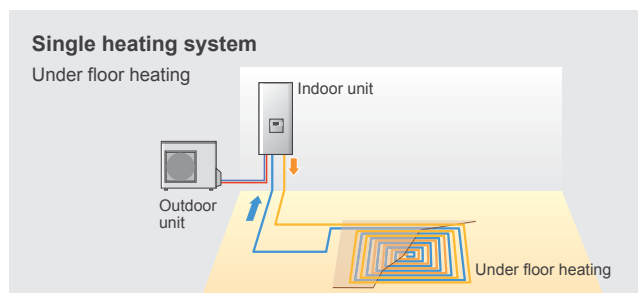

## Lineup

Capacity range (kW)		5	6	8	10	13	16
Model name	Indoor unit	 WSYA050DA	 WSYA065DA	 WSYA080DA	 WSYA095DA	 WSYA128DA	 WSYA155DA
	Outdoor unit	 AOYA18LALL		 AOYA24LALL	 AOYA30LBTL	 AOYA45LBTL	 AOYA54LJBYL

## Optional parts

### 2nd Circuit Kit



UTW-KZSXA

### Boiler Connection Kit



UTW-KBSXA

### Balancing Vessel



UTW-TEVXA

### DHW Kit



UTW-KDWXA

### DHW Tank 200L



UTW-T20XA

### DHW Tank 300L



UTW-T30XA

### High Flow Rate Circulating Pump Kit



UTW-PHFXA

### Swimming Pool Kit



UTW-KSPXA

### Heat exchanger for swimming pool



UTW-ESPXA

### Cooling Kit



UTW-KCLXA

### Cooling Kit (High flow rate)



UTW-KCHXA

### Remote Control

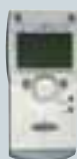

UTW-C75XA

### Room Thermostat



UTW-C55XA



## Dimensions Models: WSYA050DA / WSYA065DA / WSYA080DA WSYA095DA / WSYA128DA / WSYA155DA

(Unit : mm)

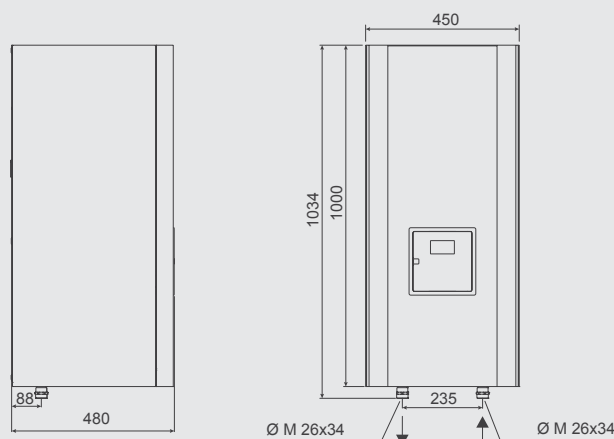

## Specifications

Capacity range (kW)		5	6	8	10	13	16	
+7°C/+35°C floor heating	Heating capacity	W	5000	6500	8000	9500	12800	15500
	Input power		1160	1630	1880	2370	3120	3880
	COP		4.30	4.00	4.25	4.00	4.10	4.00
-7°C/+35°C floor heating	Heating capacity	W	4800	5600	7000	8100	11000	13800
	Input power		1750	2240	2540	3520	3790	5300
	COP		2.75	2.50	2.76	2.30	2.90	2.60
+7°C/+45°C radiators	Heating capacity	W	4150	5400	6200	7900	9700	13300
	Input power		1150	1610	1680	2390	3130	4090
	COP		3.60	3.35	3.30	3.30	3.10	3.25
-7°C/+35°C radiators	Heating capacity	W	4050	5100	5900	7900	8300	11000
	Input power		1720	2320	2620	3590	4610	5370
	COP		2.35	2.20	2.25	2.20	1.80	2.05
Electric heater	W	2 x 1500	2 x 1500	2 x 1500	2 x 3000	2 x 3000	2 x 3000	
<b>Indoor unit</b>	<b>Model name</b>	<b>WSYA050DA</b>	<b>WSYA065DA</b>	<b>WSYA080DA</b>	<b>WSYA095DA</b>	<b>WSYA128DA</b>	<b>WSYA155DA</b>	
Dimensions H x W x D	mm	1000 x 450 x 480						
Net weight / filld weight	kg	52.5 / 77.5						
<b>Hydraulic characteristics</b>								
Buffer tank capacity	l	25						
Expansion Vessel capacity	l	8						
Water flow rate (min./max.) 4°C < ΔT < 8°C	l/h	540 / 1100	600 / 1400	860 / 1700	1000 / 2050	1380 / 2700	1670 / 3300	
<b>Electrical connections</b>								
Power source		230V~, 50Hz						
Circuit breaker	A	16	16	16	30	30	30	
<b>Outdoor unit</b>	<b>Model name</b>	<b>AOYA18LALL</b>	<b>AOYA24LALL</b>	<b>AOYA30LBTL</b>	<b>AOYA45LBTL</b>	<b>AOYA54LJBYL</b>		
Power source		230V~, 50Hz						
Rated current	A	8.3	10.6	11.7	16.7	20.6		
Circuit breaker	A	16	16	16	25	32		
Dimensions H x W x D	mm	578 x 790 x 300	578 x 790 x 315	830 x 900 x 330	1290 x 900 x 330	1290 x 900 x 330		
Weight	kg	40	44	64	98	105		
Noise level *1	dB(A)	39	40	41	40	40		
Operation range	°C	-15~24						
Refrigerant		R410A						
<b>Cooling characteristics</b>								
Connection pipe diameter	Liquid	mm	Ø6.35	Ø6.35	Ø9.52	Ø9.52	Ø9.52	
	Gas		Ø12.7	Ø15.88	Ø15.88	Ø15.88	Ø15.88	
Refrigerant charge	g	1250	1700	2200	3350	3400		
Min. / max. length	m	5 / 25	5 / 30	5 / 50	5 / 50	5 / 70		
Max. height difference	m	15	20	30	30	30		
Max. pipe length (chargeless)	m	15	15	15	20	20		
Additional charge amount per 1m	g	20	20	40	50	40		

\*1. Sound pressure level measured at distance of 5m from the device and at a height of 1.5m above ground in free field

# Deodoriser



This solves your problems with distracting lifestyles smells and other stubborn smells.

## Deodorisation capacity

Approx. **150 times**<sup>\*1</sup>  
*that of an air cleaner*  
(compared to conventional Fujitsu General products)

## Bacteria elimination power

Removes **99.9%**<sup>\*2</sup>  
*of airborne bacteria*

## Economical

*Filter replacement unnecessary*<sup>\*3</sup>

\*1. Compared to our Model ACS-24NVU Air Cleaner using urine (substituted with ammonia), food and raw garbage (fermented beans used as compound odour). However, approximately 50 times the deodorising capability (our company's study) for faecal waste (skatol and compound odour). Tested with constantly emitted odour. Calculated from the fact that the balance ratio of concentration for the same generation volume with the concentration of odour intensity level 1 as 10 times is inversely proportional to the removal capability.

\*2. Test organization: Kitasato Research Center of Environmental Sciences. Checked in UV deodorant system.

\*3. Washing with water once a year is the standard when cleaned with a vacuum cleaner once a month. (The cleaning frequency can vary depending on the conditions of use in the home. Replacement may also be necessary, depending on the condition of use.)

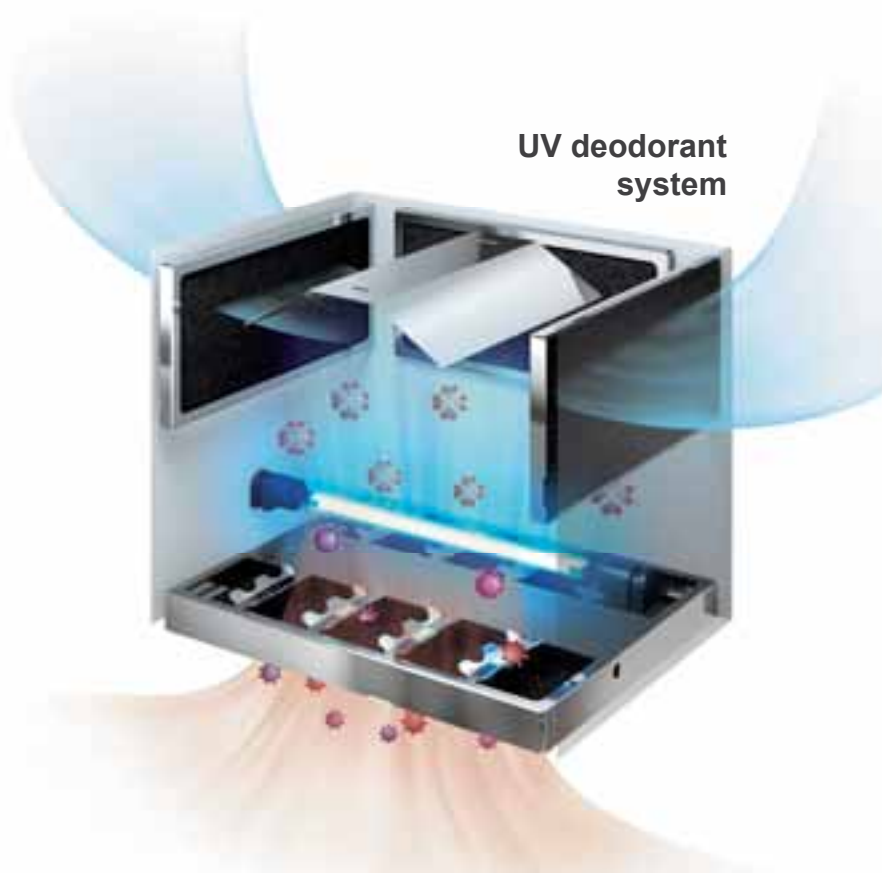

UV deodorant system

*Powerfully deodorises*  
*Almost all odours*

THE POSSIBILITIES ARE INFINITE **FUJITSU**



For Comfortable Life  
**AIR DEODORISER**



**Deodoriser**

FUJITSU GENERAL LIMITED

# AIR DEODORISER

Powerfully removes odours by the world's first deodorisation decomposition technology. Simultaneously displays air cleaning and bacteria elimination effects, and makes living more pleasant.



DASY30S

## 2 WORLD FIRST functions.

### UV deodorant system

**WORLD FIRST** \*1

Powerful deodorisation & bacteria elimination by 3 wavelengths\*2

#### Ozone deodorisation

Large volume of ozone is generated by light (185nm). Ozone power decomposes odour molecules.

#### Photo catalytic deodorisation

Odour molecules are decomposed by illuminating a titanium oxide plate with light (254nm).

#### Bacteria elimination

Bacteria and virus are repelled by light (185nm) having a bacteria elimination power 1600 times that of sunlight.

### Automatic deodorisation capability regeneration system

**WORLD FIRST** \*1

#### Deodorisation capability regenerated by heating

- Oxidation and decomposition capability is promoted by heating the filter for 30 minutes every 12 hours.
- Initial performance is maintained by removing odour molecules clinging to the filter.

#### Image of filter regeneration by heating operation

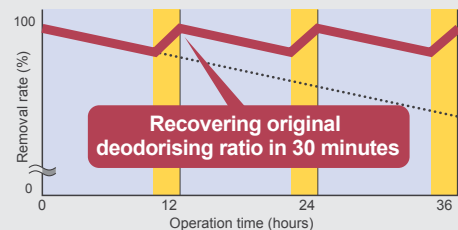

— Change of removal rate when heating operation was performed  
 ..... Change of removal rate without heating operation  
 ■ 30 minutes heating operation approximately every 12 hours

## High Performance Verification Test Results

Comparison of deodorising performance  
 Pet, human waste odour

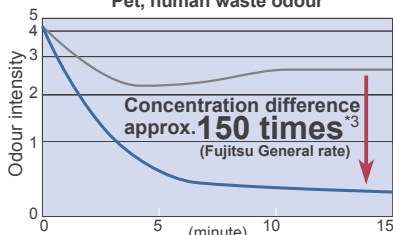

Odour intensity : 5.Very strong odour 4.Strong odour 3.Easily sensible odour 2.Weak odour but type of odour is sensed 1.Slightly sensible odour 0.No odour

Raw garbage odour

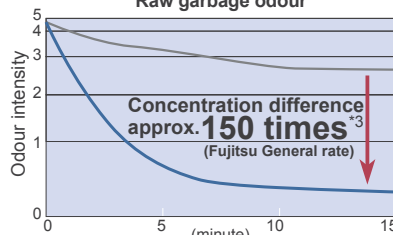

— :Home air cleaner ACS-24NUV  
 — :AIR DEODORISER DASY30S

Virus elimination rate  
 (Change of stray virus in 1m³ box)

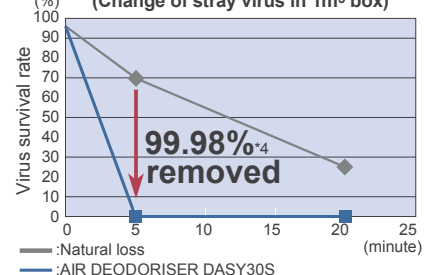

— :Natural loss  
 — :AIR DEODORISER DASY30S

## Removes permeated odours

The deodorising component\*<sup>5</sup> (weak ozone) discharged from the body decomposes and deodorises odours permeating the room from their source.

Deodorising effect of a piece of cloth permeated with the odour of 10 cigarettes  
6 stage odour intensity method  
(test room of 13.2m<sup>2</sup>)

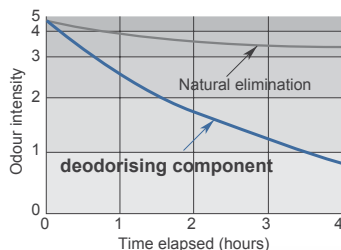

## Filter replacement unnecessary<sup>7</sup>

All filters do not require replacement. Economical

**Washable. Replacement unnecessary.**

1. Prefilter
2. Allergenic substance decomposition dust collection filter
3. Automatic deodorisation capability regeneration.
4. Heater unit
5. Compound metal oxidation catalyst honeycomb filter
6. Special activated charcoal filter

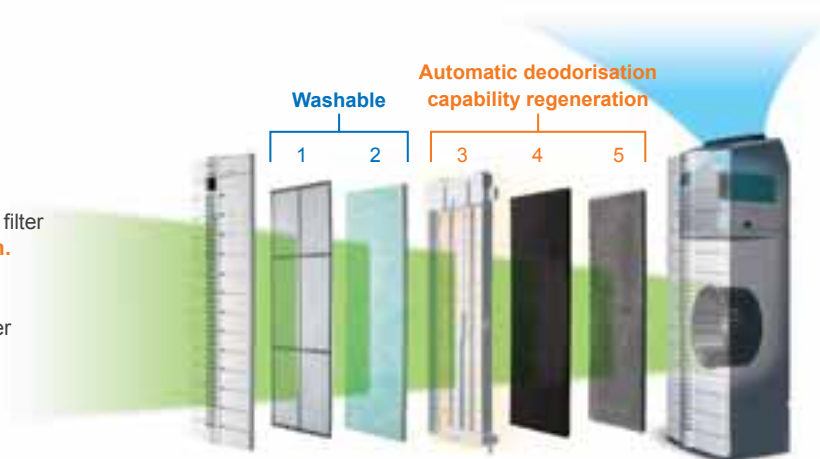

\*1. Home air deodorisation machine announced November 7, 2005. \*2. Generates light of 3 wavelengths; ozone generation 185nm, bacteria elimination 254nm, and photo catalyst activation 365nm. \*3. Compared to our Model ACS-24NVU Air Cleaner using urine (substituted with ammonia), food and raw garbage (fermented beans used as compound odour). However, approximately 50 times the deodorising capability (our company's study) for faecal waste (skatol and compound odour). Tested with constantly emitted odour. Calculated from the fact that the balance ratio of concentration for the same generation volume with the concentration of odour intensity level 1 as 10 times is inversely proportional to the removal capability. \*4. Test organization: Kitasato Research Center of Environmental Sciences. Checked in UV deodorant system. \*5. Generates very weak ozone. However, the concentration is less than the volume existing in the natural state in forests, etc. The deodorising effect varies depending on the room size and amount of ventilation. \*6. Test organization: Tested by Shinshu University using lice carcass, lice faeces, cat epidermis, dog epidermis, and orchard grass. \*7. Washing with water once a year is the standard when cleaned with a vacuum cleaner once a month. (The cleaning frequency can vary depending on the conditions of use in the home. Replacement may also be necessary, depending on the condition of use.)  
•Photographs and illustrations are images. •Harmful substances (carbon monoxide, etc.) of tobacco cannot be removed.

## Specifications

Model No.	DASY30S	
Rated voltage	V	220-240
	Hz	50/60
Operation modes	AUTO, QUIET, HIGH, HI-POWER	
Air flow	m <sup>3</sup> /min	At minimum 0.8, at maximum 3.0
Operating sound	dB	At minimum 19, at maximum 45
Power consumption	W	At minimum 11, at maximum 35
Applicable floor space	m <sup>3</sup>	~33 *By amount of generation source
Dust collection function	Non-woven fabric pleat filter	
Deodorising method	UV ozone + compound honeycomb	
Bacteria elimination method	Bacteria elimination lamp	
Filter life	Catalytic honeycomb filter: Automatic refreshing Dust collection filter: Water washing refreshing	
Sensor	Gas sensor	
Motor drive	Inverter	
Off timer	h	1
Product outside dimensions	mm	274 x 653 x 215
Product weight	kg	6.4
Installation	Floor installation (wall mounting bracket installable)	
Power cord length	m	2
Safety devices	Overcurrent prevention (current fuse)	
	Excessive temperature rise prevention (automatic reset thermostat)	
	Excessive temperature rise prevention (temperature fuse)	
Remote controller	Accessory	

# Feature Explanation

## Comfortable function



### Up / down swing flaps

The up/down flaps automatically swing up and down.



### Double swing automatic

Complex swing action of flaps enables automatically to swing both horizontal and vertical directions.



### Automatic air flow adjustment

The micro-computer automatically adjusts the air flow effectively to follow the changes of room temperature.



### Auto restart

In the event of a temporary power failure, the air conditioner will automatically restart in the same operating mode as before, once the power supply is restored.



### Auto-changeover

The unit automatically switches between heating and cooling modes based on your temperature setting and the room temperature.



### 10°C HEAT operation

The room temperature can be set to go no lower than 10°C, thus ensuring that the room does not get too cold when not occupied.



### Connectable distributing duct



### Connectable fresh air duct



### Fresh air intake

Fresh air can be taken in by a fan which can be connected using external control unit.



### Economy mode

Limits the maximum operation current, and performs operation with the power consumption suppressed.



### Energy saving mode

This mode raises the set temperature slightly in the cooling mode and lowers the set temperature in the heating mode to economically control the operation of the unit.



### V-PAM control models



### i-PAM control models



### Simultaneous multi

2 or 3 indoor units can be connected to 1 outdoor unit.



### 2-3-4 Multi rooms

Up to 4 units can be connected to 1 outdoor unit. Individual controls are available.

## Convenient function



### Sleep timer

The micro-computer gradually changes the room temperature automatically to afford a comfortable night's sleep.



### ON-OFF timer

ON-OFF timer can be set to operate once.



### Program timer

This digital timer allows selection of one of four options: ON, OFF, ON → OFF or OFF → ON.



### Weekly timer

Different on-off times can be set for each day.



### Weekly + setback timer

Weekly + Setback timer can set temperature for two times spans and for each day of the week.



### Filter sign

Indicates the filter cleaning period by lamp.

## Clean function



### Automatic filter

The filter is automatically cleaned after a set amount of time of air conditioner operation.



### UV filter cleaner

UV (ultraviolet rays) suppresses the growth of mold and germs inside the indoor unit.



### Plasma air cleaner

Electrically charged filter removes contaminants, dusts and odors. It also prevents the growth of bacteria.



### Long-life ion deodorization filter

The filter deodorizes by powerfully decomposing absorbed odors using the oxidizing and reducing effects of ions generated by the ultra-fine-particle ceramic.



### Apple-catechin filter

Fine dust, invisible mold spores, and harmful microorganisms are absorbed onto the filter by static electricity, and further growth is inhibited and deactivated by the polyphenol extracted from apples.



### Coil dry

The indoor unit can be dried to prevent the growth of mold and bacteria.



### Washable panel



# Feature summary

	Ceiling Wall	Wall Mounted	Floor	Compact Cassette / Cassette	Floor/Ceiling Universal	Ceiling	Compact Duct / Duct	High Static Pressure Duct
	ASYP09LD/12LD/18LD/24LD AWYZ14LB/18LB/24LB	ASYA07LG/09LG/12LG/14LG ASYA18LE/24LC/30LC	ASY7UB/9UC/12UC/14UB ASY18UB/24UB/30UB	AUYF12LA/14LA/18LB/24LB AGYF09LA/12LA/14LA AUYA30LB/36LB/45LC/54LC AUY25UB/14UB/18UB	AUY25UJ/30UJ/36UJ/45UJ/54UJ AUYA45LA/54LU	ABYA30LB/36LB/45LC/54LC ABY14UB/18UB/24UB ABYF12LA/14LA/18LB ARYF12LA/14LA/18LB ARY7UJ/9UJ/12UJ/14UJ/18UJ	ARYF24LB/ARYA30LB/36LB/45LC/54LC ARY25UJ/30UJ/36UJ/45LC ARY45LH/54LU/ARYC45LC/54LC ARY60UU	ARY80TL
Up / down swing flaps		● (09/12/18)	●	●	●	●	●	●
Double swing automatic	●	● (24)	●	●	●	●	●	●
Automatic air flow adjustment	●	●	●	●	●	●	●	●
Auto restart	●	●	●	●	●	●	●	●
Auto-changeover	●	●	●	●	●	●	●	●
10°C heat operation		● (18)		●				
Connectable distributing duct					●	●		●
Connectable fresh air duct					●	●	●	●
Fresh air intake						○	○	○
Economy mode	●	●		●	●	● (45)	●	●
Energy saving mode						● (54)	●	●
Sleep timer	●	●	●	●	●	○ (45)	●	○
On-off timer				● (7/9/12)				
Program timer	●	●	●	● (14)	●	○ (45)	●	○
Weekly timer								●
Weekly + setback timer		● (24)	●	●	○	●	○	●
Filter sign				●	●	● (45)	●	
Automatic filter cleaner	●							
UV filter cleaner	●							
Plasma air cleaner		●						
Long-life ion deodorization filter		●	●	○	○	●		
Apple-catechin filter		●	●	○	○	●		
Coil dry	●	●	●	●	●			
Washable panel	●	●	●	●	●			
V-PAM control models	●	● (12/18/24) (07/09)	●	●	●	●	● (30/36)	● (24/30/36)
i-PAM control models		● (09) (12)				●	● (45)	● (45)
Simultaneous multi					● (18/24)		● (18)	● (24)
2-3-4 Multi rooms				● (12/14/18)	●		●	

○ : Optional function



# FUJITSU GENERAL LIMITED

1116, Suenaga, Takatsu-ku, Kawasaki 213-8502, Japan  
<http://www.fujitsu-general.com/>

## Notice for specifications

I.U.=Indoor Unit O.U.=Outdoor Unit Qu=Quiet \* =Not decided yet

- Specifications and design subject to change without notice for further improvement. Please check with your dealer.

- Cooling/Heating capacities are based on the following conditions.

Cooling	Indoor temp. : 27°C DB/19°C WB	Heating	Indoor temp. : 20°C DB/15°C WB
	Outdoor temp. : 35°C DB/24°C WB		Outdoor temp. : 7°C DB/6°C WB



ISO 9001 Certified number:09 100 89394  
Fujitsu General (Thailand) Co., Ltd.

ISO 14001 Certified number:09 104 9245  
Fujitsu General (Thailand) Co., Ltd.



ISO 9001 Certified number:09 100 79269  
Fujitsu General (Shanghai) Co., Ltd.



ISO 14001 Certified number:104692  
Fujitsu General (Shanghai) Co., Ltd.

Distributed by :